

SG 5100

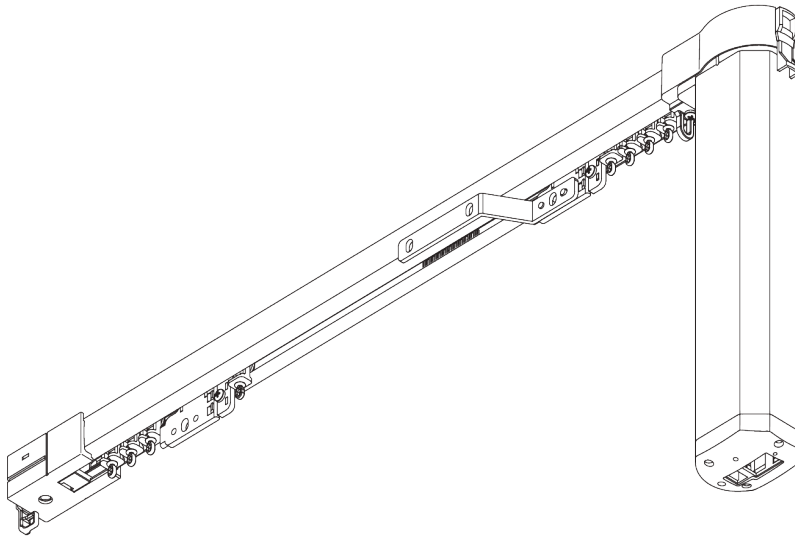
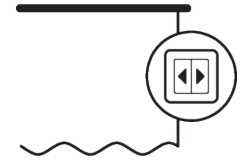

PRODUCT INFORMATION

- **Operation:** motorised
- **Range:** S - M
- **Fitting:** ceiling, wall
- **Colours:** white RAL 9016
- **Fabrics:** refer to Silent Gliss fabric collection

Features:

- Wave
- Various control options
- Touch & Go
- Manual override
- Different motor versions
- Bendable

SYSTEM SPECIFICATIONS

A. SYSTEM DIMENSIONS

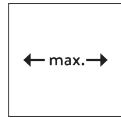

6 m



25 kg

Max. curtain weights with rollers

	3 m	6 m
	20	25
	20	25
	20	17
	20	17
	15	13
	15	13
	12	10
	12	10
(kg max.)		

Max. curtain weights with Wave gliders

	3 m	6 m
	20	20
	20	20
	18	14
	18	14
	12	10
	12	10
	10	9
	10	9
(kg max.)		

B. PROFILE

Profile and bending information

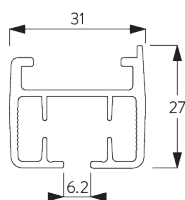

SG 10925

Profile



Radius:

>30 cm

C. HOW TO MEASURE

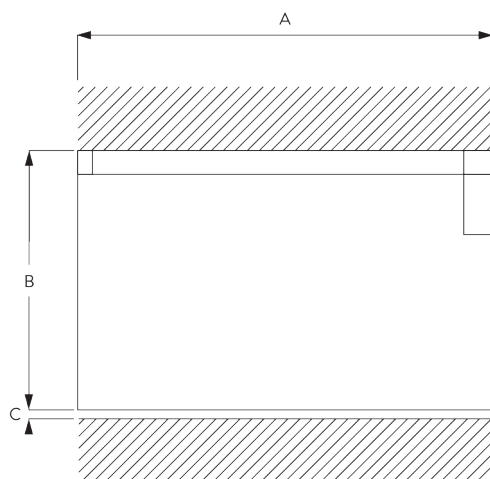

A: System width

B: System height

C: Distance between floor and fabric

D. SPECIFICATION

TEXT

EN

Silent Gliss SG 5100 Electrically Operated Curtain Track. Comprises aluminium profile SG 10925 in white complete and assembled with motor SG 5190, internal drive belt SG 10825, gliders SG 10931 at 10/m. Ceiling fix with SG 10926 clamps/ face fix with Smart Fix at maximum 500 mm centres. Operation via wireless wall switch SG 10946-49 or via low voltage contacts. Silent Gliss Wave option is available.

SV

Silent Gliss SG 5100 eldragssystem. Består av aluminiumprofil SG 10925 i specificerad längd i vitlack eller angiven RAL färg med motor SG 5190 monterad. 10 st SG 10931 glid per meter. Takmonteras med fäste SG 10926 c/c 500 mm. Vägghontering med SG Smart Fix c/c 500 mm. Styrning med trådlös väggsändare SG 10946-49 eller med lågvoltkontakt. Kan användas med system Wave.

NO

Silent Gliss SG 5100 Elektrisk gardinskinne. Består av aluminiumprofil SG 10925 i spesifisert lengde, standard i hvitlakkert eller spesifisert RAL farge. Motor SG 5190. 10 stk SG 10931 glide per meter. Takmonteres med feste SG 10926 c/c 500 mm. Veggmontering med SG Smart Fix c/c 500 mm. Styrning med trådløs veggsender SG 10946-49 eller med lavvoltage kontakt. Kan kombineres med Wave system.

DA

Silent Gliss SG 5100 elektrisk gardinskinnesystem. Består af aluminiumprofil SG 10925 i hvidt, fuldstændig samlet med motor SG 5190, drivrem SG 10825, 10 stk. glide SG 10931 pr. m. Loftmonteres med klemmer SG 10926 clamps/ væghonteres med Smart Fix med en afstand på højst 500 mm. Styres med en trådløs vægkontakt SG 10946-49 eller lavspændingskontakter. Kan bruges med Silent Gliss Wave.

FITTING

A. FITTING INFORMATION

For detailed fitting information, visit the Silent Gliss website.

Fixing points

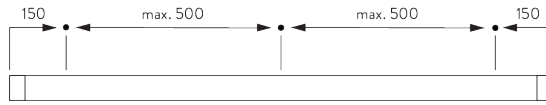

B. CEILING FITTING

Clamp SG 10926

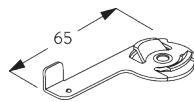
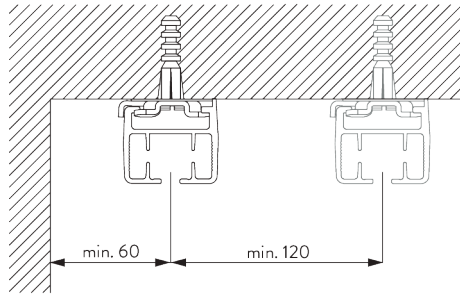

SG 10926

Clamp

C. WALL FITTING

Smart Fix

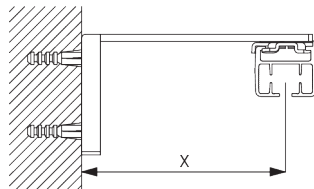

Smart Fix SG 11201 - SG 11205 and clamp SG 10926:
Screw SG 11127 (M4x10) needed.

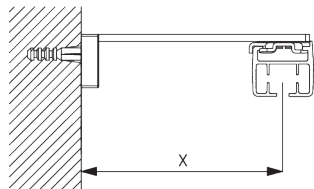

Square Smart Fix SG 11211 - SG 11215 and clamp SG 10926:
Screw SG 11127 (M4x10) needed.

Smart Fix	X mm
SG 11201 / SG 11211	72
SG 11202 / SG 11212	92
SG 11203 / SG 11213	112
SG 11204 / SG 11214	142
SG 11205 / SG 11215	192
SG 11154	102-130
SG 11155	132-160
SG 11156	182-210

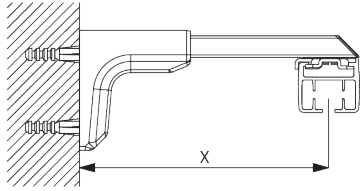

Universal Smart Fix SG 11154 - SG 11156 and clamp SG 10926:

Screw SG 11158 (M4x12) needed.

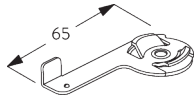

SG 10926

Clamp



SG 11127

Countersunk head screw
M4x10



SG 11158

Countersunk head screw
M4x12

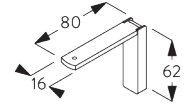

SG 11201

Smart Fix 80 mm

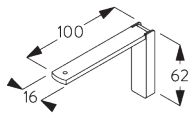

SG 11202

Smart Fix 100 mm

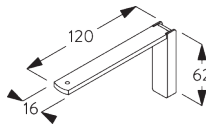

SG 11203

Smart Fix 120 mm

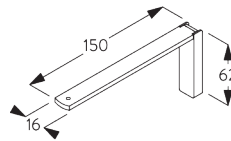

SG 11204

Smart Fix 150 mm

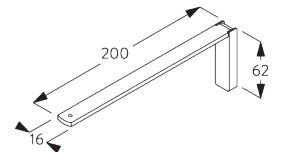

SG 11205

Smart Fix 200 mm

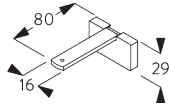

SG 11211

Square Smart Fix 80 mm

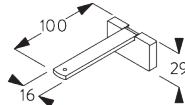

SG 11212

Square Smart Fix 100 mm

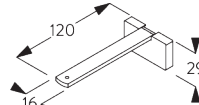

SG 11213

Square Smart Fix 120 mm

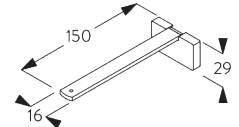

SG 11214

Square Smart Fix 150 mm

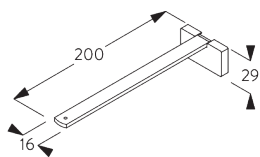

SG 11215

Square Smart Fix 200 mm

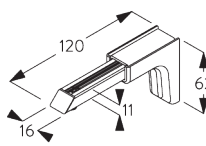

SG 11154

Universal Smart Fix 120 mm

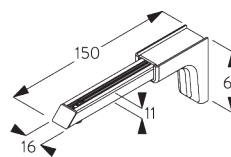

SG 11155

Universal Smart Fix 150 mm

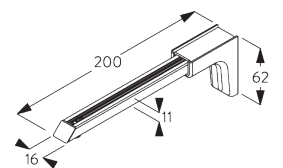

SG 11156

Universal Smart Fix 200 mm

SYSTEM OPTIONS

A. WAVE

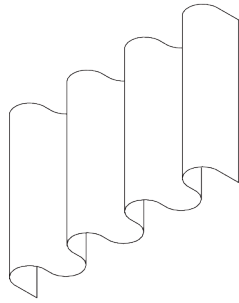

SG 6365



SG 10854



SG 10856



SG 10867



SG 10887

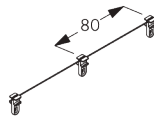

SG 10905

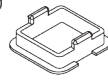

SG 10924

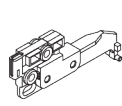

SG 10845

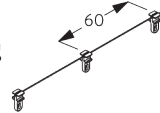

SG 10906



SG 3582

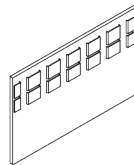

SG 6349

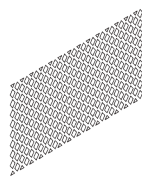

SG 6363

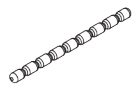

SG 10075



SG 10076

Standard components:

- SG 6365 Wave hanger
- SG 10854 Wave overlap arm support
- SG 10856 Wave end stop, belt return
- SG 10867 Panhead screw
- SG 10887 Wave overlap arm set
- SG 10905 Wave glider cord 80 mm
- SG 10924 Wave glider support

Optional components:

- SG 10845 Wave master carrier single stack 80 mm
- SG 10906 Wave glider cord 60 mm (no single stack)

Curtain components:

- SG 3582 Hook
- SG 6349 Wave curtain tape
- SG 6363 Wave top hemming tape
- SG 10075 Lead weight 50 gr/m
- SG 10076 Fabric weight

Wave stack depth - glider cord (standard components)

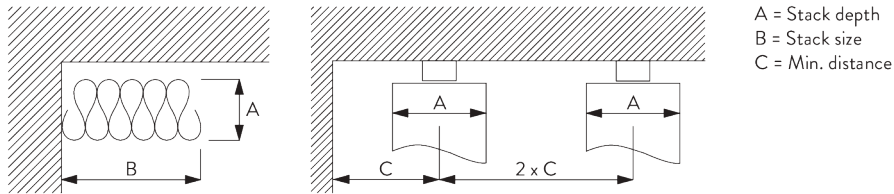

Glider cord SG 10905	Pockets between hooks	Approx. curtain fullness	Stack depth A	Stack size B*	Min distance C
80	6	~2.1	140	180 per metre of track	90
80	7	~2.3	160	180 per metre of track	100

Glider cord SG 10906	Pockets between hooks	Approx. curtain fullness	Stack depth A	Stack size B*	Min distance C
60	4	~2.1	100	230 per metre of track	70
60	5	~2.3	120	230 per metre of track	80

*Stack size B plus 180 mm for each curtain stack!

MOTORS & CONTROLS

A. MOTOR FEATURES

Motors	SG 5190	SG 5192	SG 5193
Motor Features			
Soft start / stop	●	●	●
Touch & Go	●	●	
Manual Override	●	●	●
Built-in receiver	●	●	
Electronic end-stop	●	●	●
Electronic revolution counter (unlimited revolution)	●	●	●
Parallel wiring possible without additional relays	●	●	●
Cable connectable with plug into motor		●	
IP class	IP 20	IP 20	IP 20
Control Features			
Mains power control			●
Dry contact control	●	●	
Dry contact and / or SG Control A	●	●	
SG Control A	●	●	
Suitable for all common home automation systems (with suitable interface)	●	●	●

B. MOTOR SPECIFICATIONS

Motors	Motor dimensions	Voltage	Current	Frequency	System speed / sec	Frequency receiver
SG 5190	L 293 x W 53 x D 68	100 - 240 V AC	0.8 - 0.4 A	50 / 60 Hz	15 cm / sec	433 MHz
SG 5192	L 293 x W 53 x D 68	24 V DC	3.5 A	n/a	15 cm / sec	433 MHz
SG 5193	L 293 x W 53 x D 68	100 - 240 V AC	0.8 - 0.4 A	50 / 60 Hz	15 cm / sec	n/a

C. MOTOR DIMENSIONS

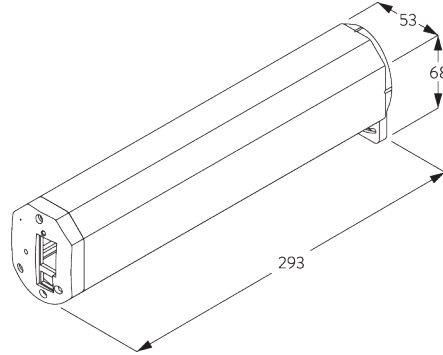

D. OPERATING METHODS

See catalogue "controls" for details.

Wall switch



System can be operated by fixed wall switch.

Silent Gliss Control A



Various radio hand-held and wall transmitters available.



E. WIRING DIAGRAMS







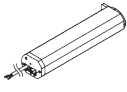
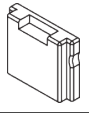
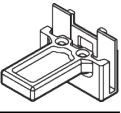
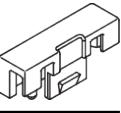
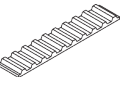
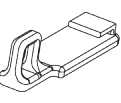

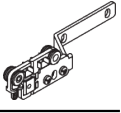
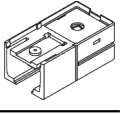
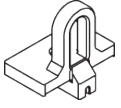
Refer to Silent Gliss website.

PARTS

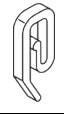
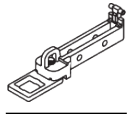
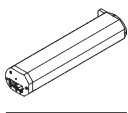
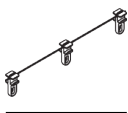
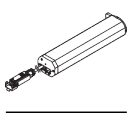
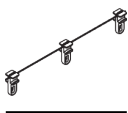
A. STANDARD PARTS

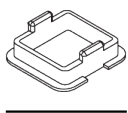
	SG 5190 Motor 100-240V AC, 1/130, radio receiver
	SG 10815 Cover
	SG 10823 Belt connector arm
	SG 10824 Belt connector pin
	SG 10825 Belt
	SG 10836 Mask pair stack
	SG 10931 Roller
	SG 10936 Overlap arm
	SG 10940 Guide return
	SG 10945 End stop

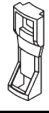
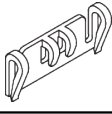
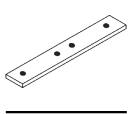
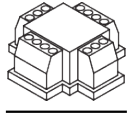
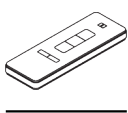
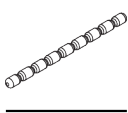
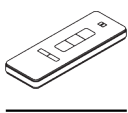
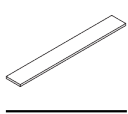
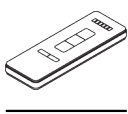
B. OPTIONAL PARTS

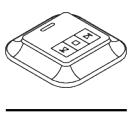
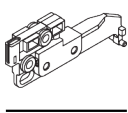
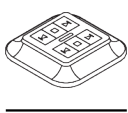
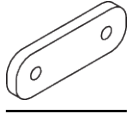
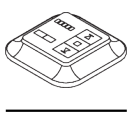
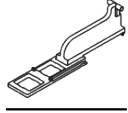
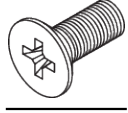
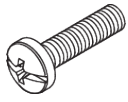
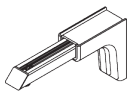
	SG 3582 Hook		SG 10887 Wave extension
	SG 5192 Motor 24V DC, 1/130, radio receiver		SG 10905 Wave glider cord 80 mm
	SG 5193 Motor 100-240V AC, 1/130, mains controlled		SG 10906 Wave glider cord 60 mm
	SG 6349 Wave curtain tape		SG 10924 Wave glider support
	SG 6363 Wave top hemming tape		SG 10927 Hook
	SG 6365 Wave hanger		SG 10943 Connection bridge
	SG 9959 Central control unit relay		SG 10946 Radio hand held 1 channel
	SG 10075 Lead weight 50 g/m		SG 10947 Radio hand held 2+1 channel
	SG 10076 Fabric weight		SG 10948 Radio hand held 6+1 channel
	SG 10822 Master carrier		SG 10949 Radio wall transmitter 1 channel
	SG 10845 Wave master carrier 80 mm		SG 10950 Radio wall transmitter 2 channel
	SG 10854 Wave overlap plate		SG 10951 Radio wall transmitter 5+1 channel
	SG 10856 Wave extension		SG 11127 Countersunk head screw M4x10
	SG 10867 Pan head screw Freedriv M4x16		SG 11154 Universal Smart Fix 120 mm

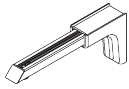

SG 11155
Universal Smart Fix 150 mm

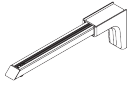

SG 11156
Universal Smart Fix 200 mm

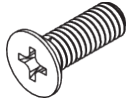

SG 11158
Countersunk head screw M4x12

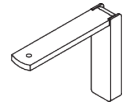

SG 11201
Smart Fix 80 mm

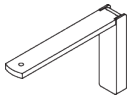

SG 11202
Smart Fix 100 mm

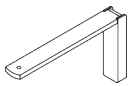

SG 11203
Smart Fix 120 mm

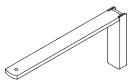

SG 11204
Smart Fix 150 mm

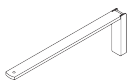

SG 11205
Smart Fix 200 mm

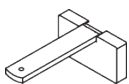

SG 11211
Square Smart Fix 80 mm

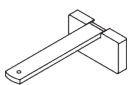

SG 11212
Square Smart Fix 100 mm

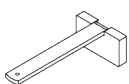

SG 11213
Square Smart Fix 120 mm

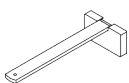

SG 11214
Square Smart Fix 150 mm

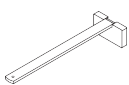

SG 11215
Square Smart Fix 200 mm

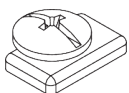

SG 11295
End stop

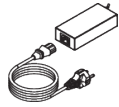

SG 11414
Power supply 24V / 4A including
cable EU plug

