

LECKEY[®]



**ALL
GROWN
UP** OUR NEW
**KIT SEATING
SYSTEM
FOR TEENS
& ADULTS**

**KIT IS A
HIGHLY
ADJUSTABLE
MODULAR
SEATING
SYSTEM
FOR TEENS &
ADULTS WITH
COMPLEX
POSTURAL
NEEDS.**



**OUR R&D APPROACH TO
KIT HIGHLIGHTED THE
SHIFT IN POSTURAL, SOCIAL
AND ENVIRONMENTAL
NEEDS BETWEEN CHILDREN
AND ADULTS.**

**DESIGNED TO BRIDGE THE
GAP BETWEEN MODULAR
AND MOULDED SEATING,
KIT HAS BEEN DEVELOPED
USING A RIGOROUS
APPROACH OF RESEARCH,
TRIALS AND TESTING.**





Extensive Research Into Users' Needs

Understanding the changing postural, functional, comfort and social needs of teens and young adults.

Extensive Clinical Trials

Undertaking over 60 trials with 40 teens and adults with complex postural needs.

Extensive Product Testing

Exceeding international standards for strength, durability and crash testing.

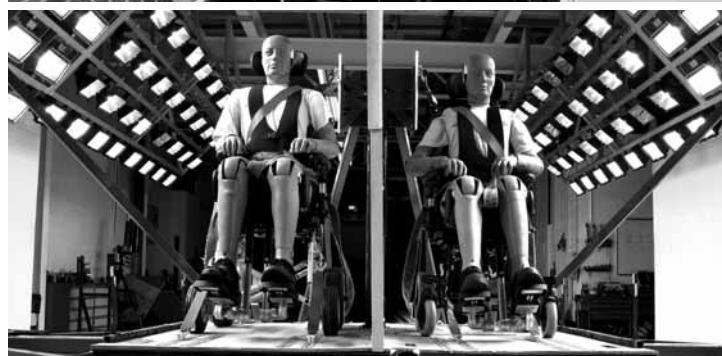

**AS A RESULT OF OUR
R&D APPROACH KIT
HAS THE ABILITY TO
ACCOMMODATE AND
SUPPORT COMPLEX PELVIC,
TRUNK AND LOWER LIMB
CHALLENGES USING
ITS INNOVATIVE RANGE
OF INTERCHANGEABLE
MODULAR COMPONENTS.**



**INTERCHANGEABLE
BACKREST COMPONENTS.**



THE PELVIC CRADLE (Patent Pending)

This unique support wraps around the buttocks and posterior of the pelvis to encourage and maintain an upright and functional posture.

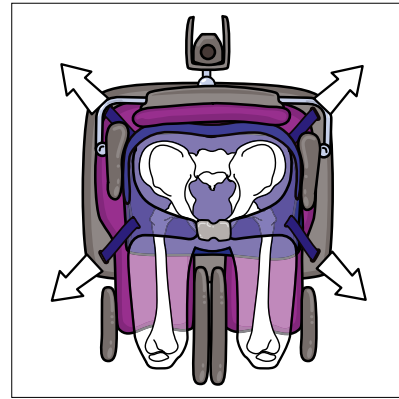
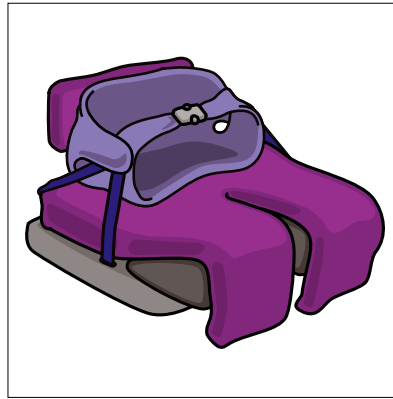

BALL & SOCKET JOINTS

To support and accommodate complex postures, we have fitted a number of the modular components with ball & socket joints to achieve the full range of adjustment.

1. Shoulder support
2. Thoracic support
3. Sacral support
4. Footplates

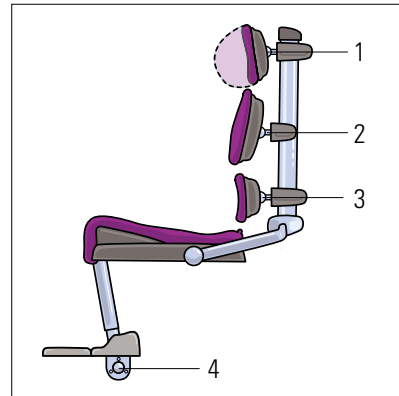
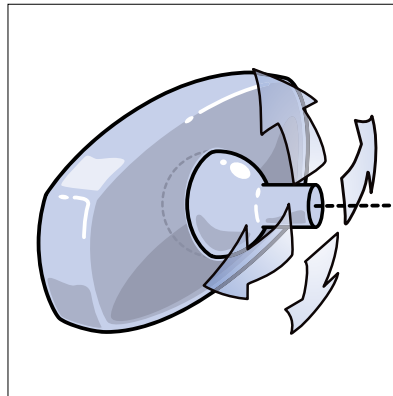

3-PART BACKREST AND THORACIC OPTIONS

Each section of the backrest is attached by ball and socket joints to the central spine and comes with a choice of thoracic supports, so the backrest can be easily tailored to match individual needs. The shoulder and sacral supports are also depth adjustable.

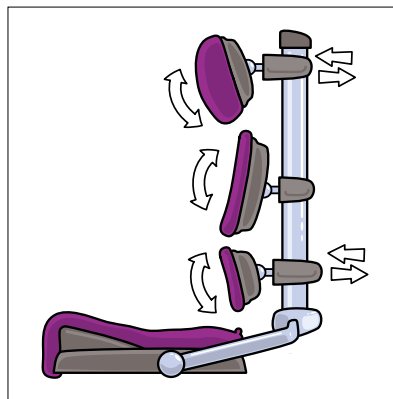

3 part backrest with ball & socket joints (Side view)

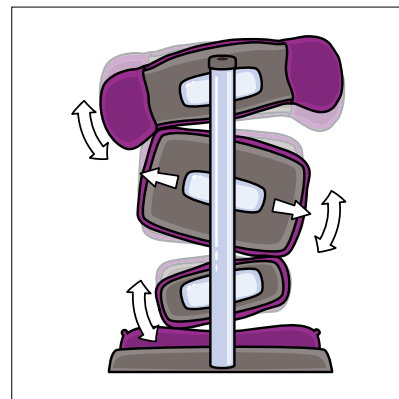

3 part backrest with ball & socket joints (Back view)

LOWER LIMB POSITIONING

Multi-positional leg guides and footplates can securely accommodate a wide spectrum of lower limb issues.

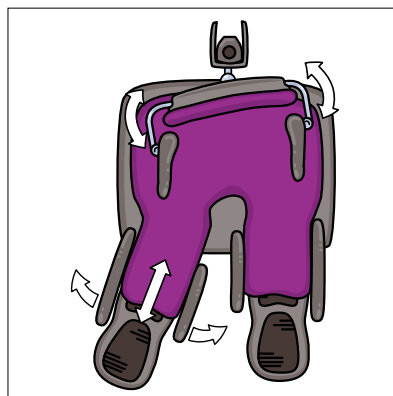

Multi-adjustable leg and foot supports

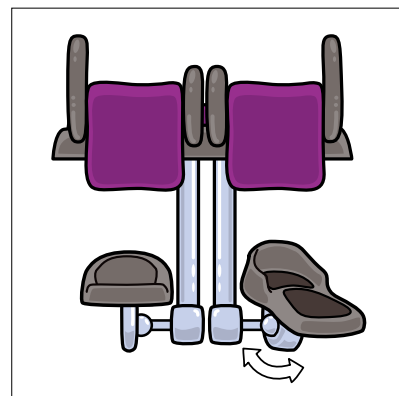

Multi-adjustable ball & socket joint foot supports

KIT'S UNIQUE DESIGN IS FOCUSED ON THE SPECIFIC NEEDS OF TEENS AND YOUNG ADULTS WHO TEND TO HAVE MORE COMPLEX POSTURES AND WHO SPEND LONGER IN THEIR SEATING SYSTEMS. FOR THEM, FUNCTION MEANS INDEPENDENCE AND THE SEATING SYSTEM BECOMES AN ESSENTIAL PART OF THEIR LIFESTYLE.

TRANSFERS AND EASE OF USE

Removable and flip-away components allow easy access for hoisting.

Flip up foot supports allow user to get close enough for standing transfers.

All cushion covers are removable and machine washable.

BASES

Hi-low chassis available with hydraulic and powered height adjustment. Other outdoor manual and powered bases are also available.



10. Contoured headrest

9. Contoured shoulder support

5. Thoracic support

1. The Pelvic Cradle

12. Adjustable armrests

14. Upper leg gables (large & small)

2. One piece seat cushion

15. Multi-adjustable ball & socket foot support

17. KIT Hi-low chassis

6. Standard flip away lateral supports

11. Removable machine washable covers

18. Push handle

1. The innovative Pelvic Cradle (patent pending) with 4 point positioning straps provides proximal positioning for users with high or low tone and can be used to accommodate or correct the pelvis.
2. Comfortable ramped one piece seat cushion, which is 75mm deep on Size 1 and 95mm deep on Size 2, supports the ischial tuberosities and helps prevent the user from sliding forward. Additional foam inserts can be used to accommodate fixed obliquity.
3. The height, depth and angle adjustable sacral support is the lowest section of the 3-part backrest, and can be adjusted for multiple positions using its ball and socket joint to accommodate complex user needs.
4. Angle, depth and width adjustable hip laterals can be used with the Pelvic Cradle to help align and stabilise the pelvis.
5. The height adjustable thoracic support is the mid section of the 3-part backrest and can be set up using its multi-adjustable ball and socket joint. It can also be moved to the left or right to accommodate severe scoliosis. Any combination of the standard, complex and angle adjustable laterals can be easily attached to this support to meet the user's needs.
6. The standard flip away lateral supports have independent angle, depth and height adjustment providing the user with thoracic support to help maintain a stable upright position.
7. The multi-adjustable complex lateral supports can contour to varying thoracic shapes, in both a horizontal and vertical orientation, increasing surface area contact for improved postural support and comfort. They can be flipped out of the way to facilitate transfer.
8. The angle adjustable laterals provide moderate side support, ideal for users who require less thoracic support.
9. The height and depth adjustable contoured shoulder support is the top section of the 3-part backrest. It can be positioned via its multi-adjustable ball and socket joint and angle adjusts to provide shoulder protection which helps balance the head and trunk over the pelvis and improves hand control e.g. to use communication devices.
10. Large cushioned headrest with angle, depth and 25mm lateral adjustment. Other head support options, such as Whitmyer or Otto Bock, can also be used.
11. All cushion covers are removable and machine washable. Infection control covers are also available.
12. Cushioned height and angle adjustable armrests can be easily removed to facilitate transfer.
13. Multi-positional leg guides can securely accommodate a wide range of lower limb positions, including up to 20° windsweeping.
14. Interchangeable large and small upper leg gables support abduction, adduction and windsweeping.
15. Flip-up foot supports, which can be individually positioned using the multi-adjustable ball and socket joints, move with the leg guides to maintain the lower leg positioning.
16. Communication devices - the KIT seat has been designed to enable a range of communication devices to be easily attached, allowing the communication aid to move with the seat as its height or tilt is altered (Daessy mounting hardware shown).
17. Hi-low chassis has been redesigned with hydraulic height adjustment for the KIT Seating System. Its 12" rear wheels and 6" front wheels make it very easy to manoeuvre over uneven surfaces.
18. Height adjustable push handles allow the chair to be easily moved.

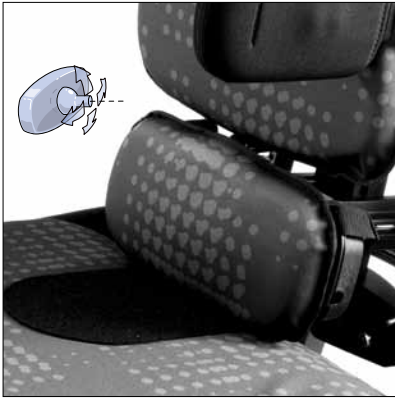

3. Sacral support



4. Hip laterals with angle, depth and rotational adjustment



7. Complex lateral supports - horizontal

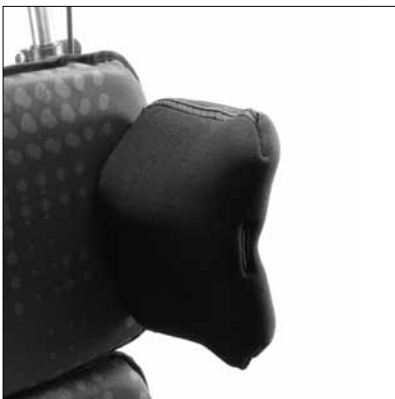

7. Complex lateral supports - vertical



8. Angle adjustable laterals with one piece thoracic cushion



13. Abduction / Adduction



13. Windsweeping



16. Communications device attachment



15. Multi-adjustable flip-up foot supports

**AS KIDS GROW INTO TEENS
AND TEENS GROW INTO
ADULTS, THEIR NEEDS AND
THE REQUIREMENTS OF
THEIR CARERS CHANGE.
INDEPENDENCE BECOMES MORE
IMPORTANT AND THEY DEPEND
MORE ON THEIR SEATING
SYSTEM AND THE MOBILITY
THAT IT GIVES THEM.**







POSTURE, FUNCTION & COMFORT

**THE KIT SEATING SYSTEM'S
GROUND BREAKING DESIGN IS THE
CULMINATION OF OVER 25 YEARS'
EXPERIENCE WORKING WITH
PARENTS, THERAPISTS, TECHNICIANS
AND USERS FROM ALL OVER THE
WORLD. IT HAS BEEN DESIGNED TO
ALLOW THERAPISTS TO OPTIMISE
POSTURE, FUNCTION AND COMFORT.**



POSTURE, FUNCTION & COMFORT

PELVIC STABILITY

The most important feature of any seating or mobility system is its ability to provide pelvic stability (for tilt, rotation and obliquity) as this gives the optimum base for trunk and head alignment and upper limb function. The KIT Seating System provides uniquely adaptable pelvic support for teenagers and adults with some of the most challenging pelvic positions, both in terms of achieving optimal alignment and providing comfortable accommodation of their postural needs.

POSTURE

PELVIC STABILITY ISSUES

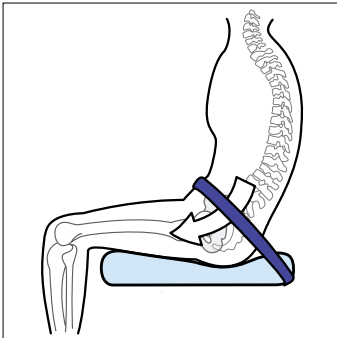

Posterior pelvic tilt

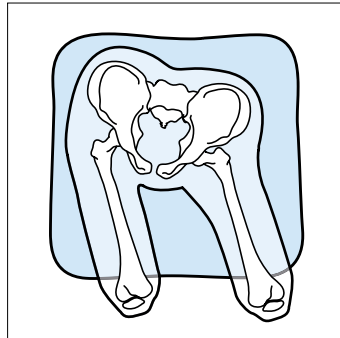

Pelvic rotation and windsweeping

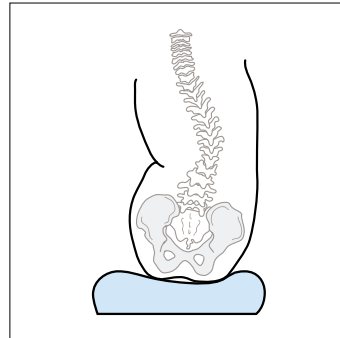

Pelvic obliquity

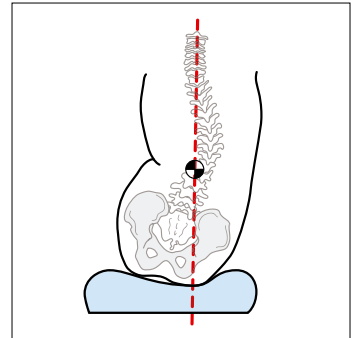

Alignment

THE PELVIC CRADLE

The KIT Seating System is supplied with the exclusive Pelvic Cradle (patent pending) as standard. The flexible adjustment in the back section can encourage a posteriorly tilted pelvis into neutral alignment, and the overall design prevents users sliding forward. Available in three sizes to ensure the best possible fit, the Pelvic Cradle gives unsurpassed proximal pelvic positioning and support for more complex body shapes.

Where pelvic mobility is reduced, and tilt, rotation or obliquity need to be accommodated, the Pelvic Cradle can successfully stabilise the pelvis in these unique positions.



SET UP FOR TRANSFER

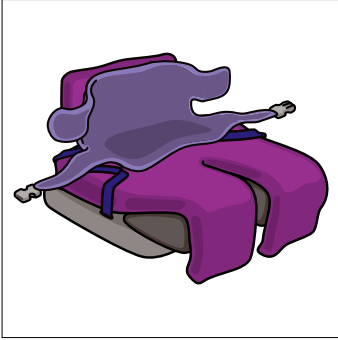

The Pelvic Cradle opens flat making access for self-transfers and hoisting straightforward.

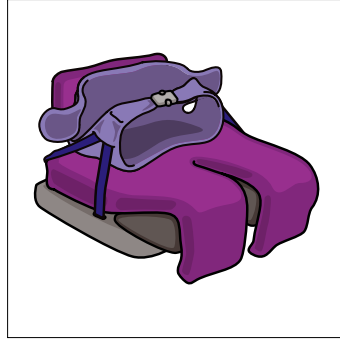

The front buckle secures users safely in position.

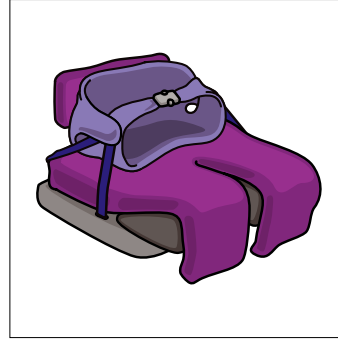

Adjustable Velcro side fastening tabs firmly support a range of positions from fixed posterior pelvic tilt to a functional anterior posture.

PELVIC CRADLE POSITIONING

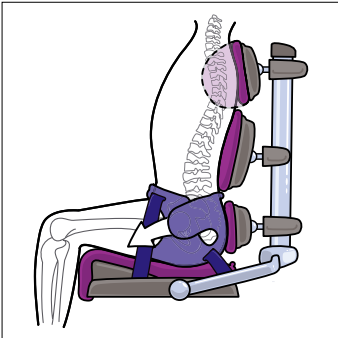

The adjustable Velcro side tabs provide an anterior pull, giving secure and comfortable support at the posterior of the pelvis and sacrum, and facilitating optimal pelvic positioning.

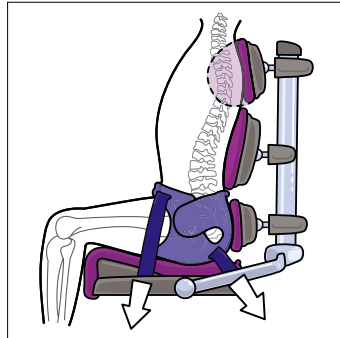

The 4-point attachment ensures the user cannot submarine under the anterior strap.

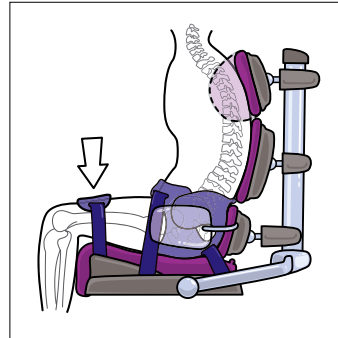

Used in conjunction with the Pelvic Cradle, the leg straps help prevent users with kyphotic postures from sliding into posterior tilt.

HIP PADS

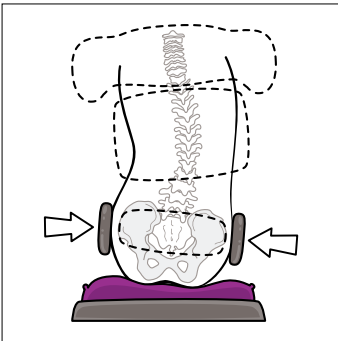

Individually adjustable hip pads can be used to provide further support for the pelvis, even for users with complex needs.

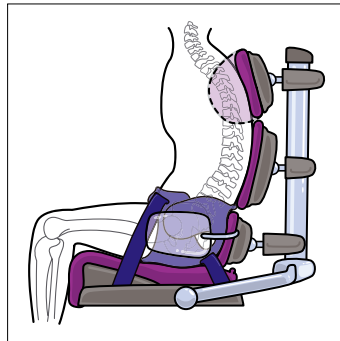

When the backrest is set up to accommodate complex postures, the hip guides can be rotated to remain horizontal with the seat base.

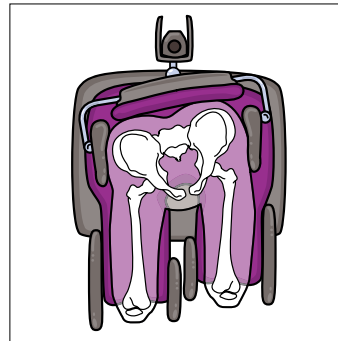

For users with spinal rotation, rotation of the sacral pad ensures balanced contact between the back support and buttocks. Hip guides can rotate in opposite directions to remain parallel with the femoral supports.

GLUTEAL RAMP AND UNDER THIGH PADDING

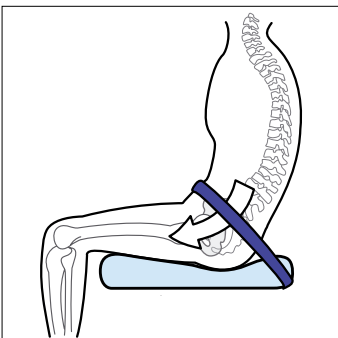

Users with strong extensor patterns will often require additional support to help prevent their pelvis from sliding into posterior tilt.

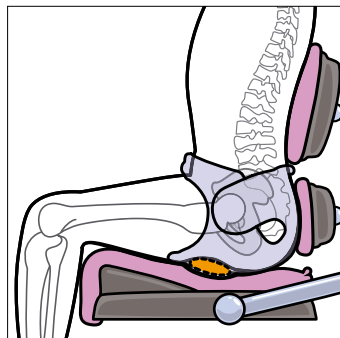

If additional pelvic support is required, the simple gluteal ramp can help to prevent the forward excursion of the ischial tuberosities, maintaining stability of the pelvis in an optimum position.

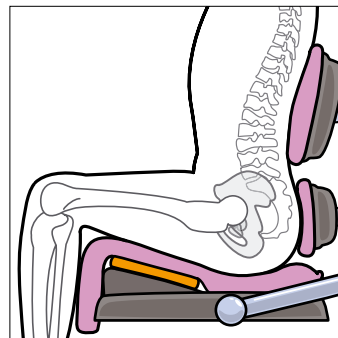

Additional high density foam can be simply added under the cushion to accommodate pelvic obliquity or to provide additional support under the ischial tuberosities or femurs.

POSTURE, FUNCTION & COMFORT

TRUNK & HEAD ALIGNMENT

Seating systems need to provide appropriate trunk and head support because this contributes to the stability of the pelvis, and facilitates upper limb function, concentration, and social interaction. The KIT Seating System's trunk and head supports can be individually tailored to match the needs of each user.

POSTURE

TRUNK & HEAD ALIGNMENT ISSUES

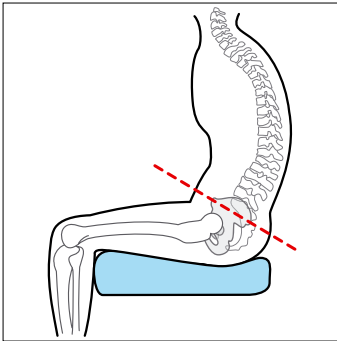

Kyphosis

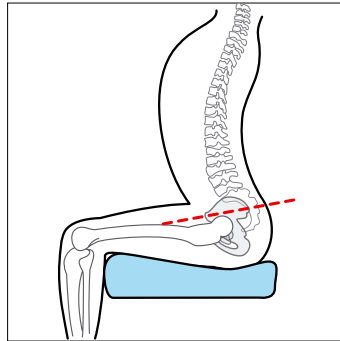

Lordosis

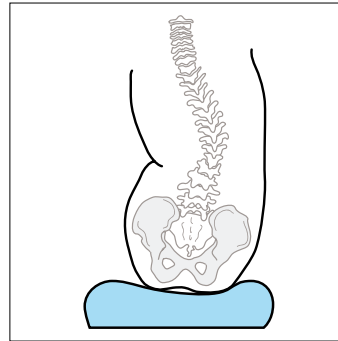

Scoliosis



TRUNK SUPPORT

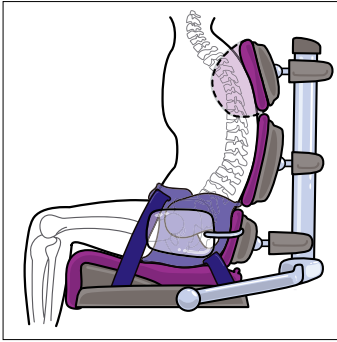

Individual adjustment of backrest pads ensures fixed kyphotic postures are fully supported from the cervical spine down to the sacrum. (Hip guides can be rotated to remain horizontal with the seat base).

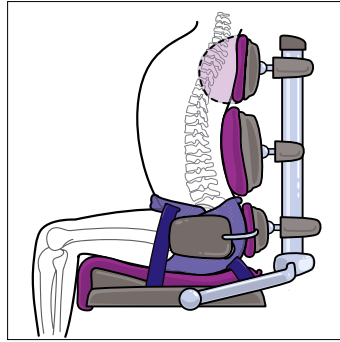

Hyper lordotic postures can be stabilised and supported along the entire length of the spine by simple configuration of the backrest pads.

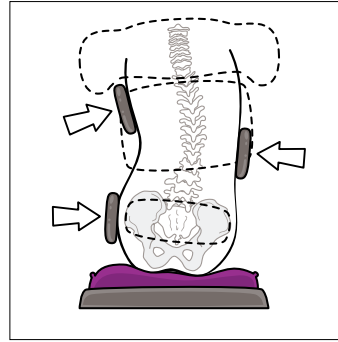

Height, width and angle adjustable lateral supports used in conjunction with hip guides provide 3-point loading to accommodate or correct scoliotic postures.

THORACIC STANDARD & ANGLE ADJUSTABLE LATERALS



The standard laterals provide the user with thoracic support but can be flipped away for ease of transfer.

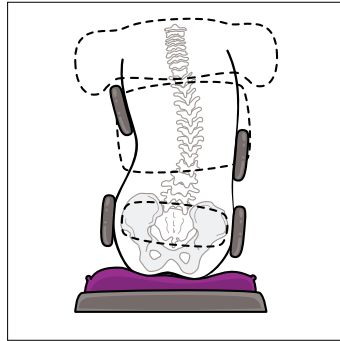

The thoracic laterals in conjunction with the hip pads can be used to maintain good sitting balance for users with complex postural needs.

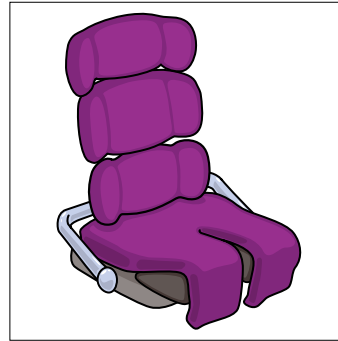

The angle adjustable laterals can be individually adjusted to contour the one piece thoracic cushion to the user's shape.

THORACIC COMPLEX LATERALS



Vertical and horizontal complex laterals can be combined to provide appropriate levels of support.

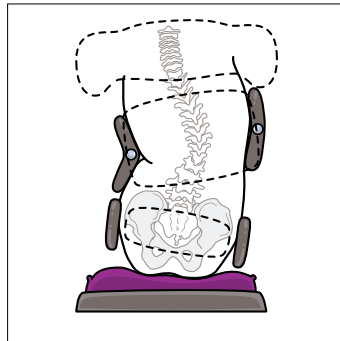

Complex multi-adjustable lateral pads improve pressure distribution by providing an increased surface area to support a fixed scoliosis.



Contouring around a kypho-scoliosis and associated rib hump is easily achieved by rotating the thoracic pad and positioning the multi-adjustable complex laterals around the user's individual shape.

SHOULDER & HEAD



Shoulder support laterals can be individually angled up to 90°.



The unique shoulder protraction system stabilises the shoulder girdle improving head control and moves the upper limbs into the optimal position for functional activities e.g. using communications devices.

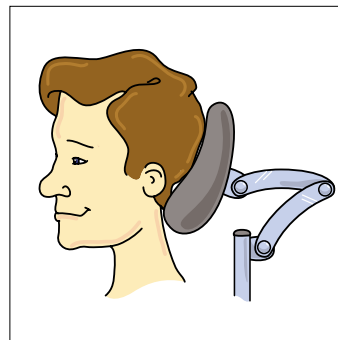

The triple-axis headrest mount ensures correct support for head and neck.

POSTURE, FUNCTION & COMFORT

LEG & FOOT POSITIONING

Seating systems also need to provide appropriate leg and foot support as this plays a crucial role in maintaining the stability of the pelvis, and therefore the alignment of the trunk and head. Often overlooked, hamstrings are frequently tight in those with limited movement and can disturb pelvic stability. In addition, the feet take up to 19% of body weight, and when unsupported can add to pressure and pelvic stability issues. The KIT Seating System's pioneering leg and foot supports enable the user's legs and feet to be supported in a wide range of positions.

POSTURE

LEG & FOOT POSITIONING CHALLENGES

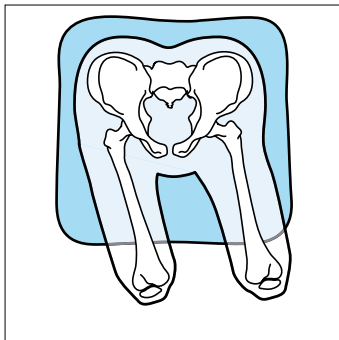

Windsweeping

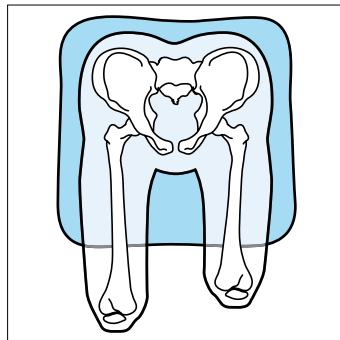

Real leg length discrepancy

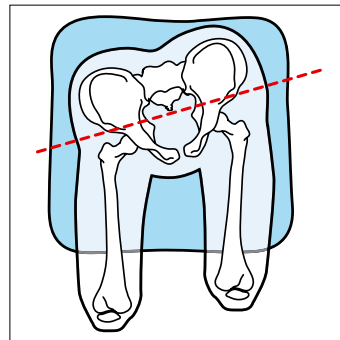

Apparent leg length discrepancy caused by fixed pelvic rotation

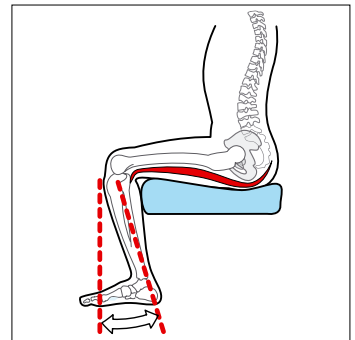

Tight hamstrings



WINDSWEEPING AND LEG LENGTH DISCREPANCIES

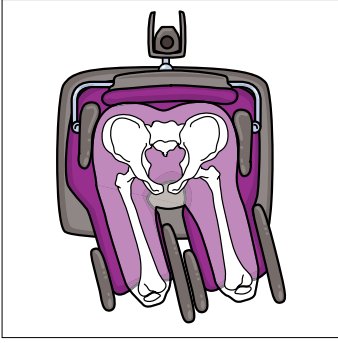

Accommodation of up to 20° windsweeping from midline ensures the pelvis remains square against the backrest and the head and trunk face forward.

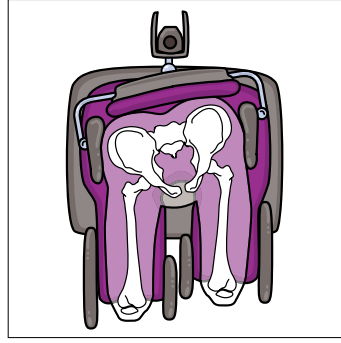

Adjustable femoral supports accommodate actual or apparent leg length differences.

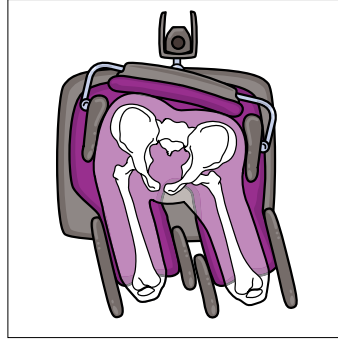

Where spinal rotation is fixed, the ability of the sacral pad and leg guides to independently rotate means that the posture can be accommodated allowing the trunk and head to face forwards, enhancing function and social inclusion.

TIGHT HAMSTRINGS

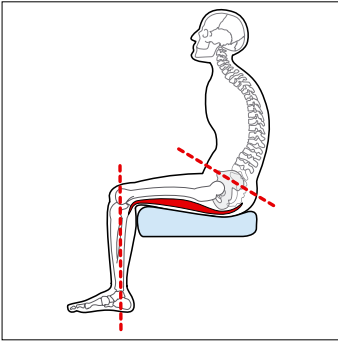

For users with tight hamstrings, if the lower leg is positioned at 90° to the upper leg, the pelvis will be pulled into posterior tilt.



Lower leg supports can be individually positioned to suit the user's needs.

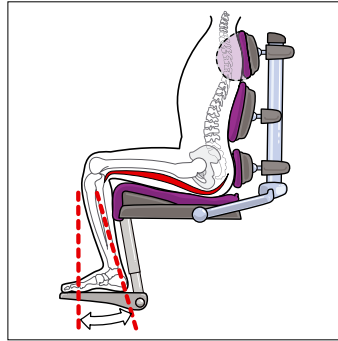

Positioning the feet behind the knees prevents sacral sitting for users with tight hamstrings.

FOOT POSITIONING



Footplates can be angled individually to maximise foot loading and overall postural stability.



Internal/external rotation, varus/valgus and plantar/dorsi flexion can all be accommodated by rotation of the multi-adjustable foot supports.

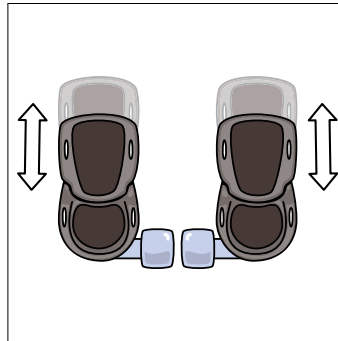

Footplates can be adjusted to match the user's foot size.

POSTURE, FUNCTION & COMFORT

FUNCTION

Where it can be achieved, the optimum position of the pelvis for function is in neutral or slight anterior tilt. This pelvic position allows the spine to adopt its natural lumbar, thoracic and cervical curves, aligning the trunk and balancing the head. In turn, when the body is well supported, it maximises the potential for upper limb function; improves opportunities for social interaction; and maximises breathing and digestive capacity.

LEG & FOOT POSITIONING CHALLENGES

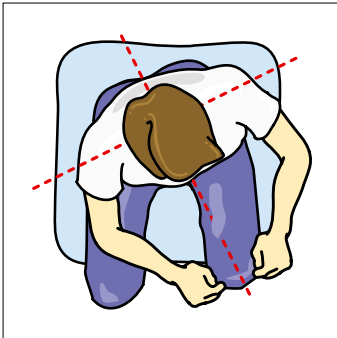

If windswept legs are forced into midline when there is not the range of movement available, the pelvis compensates by rotating, and the trunk and head follow.

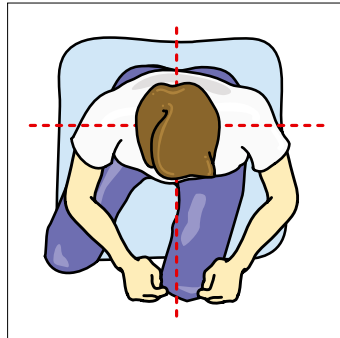

The leg guides on KIT can accommodate windsweeping, allowing the pelvis to remain level with the back of the seat, and the trunk and head to face forward.

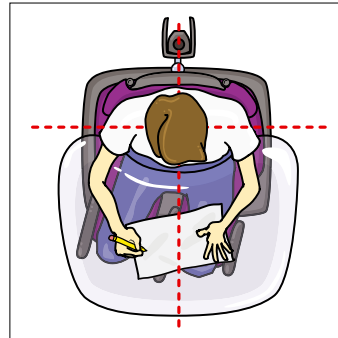

Allowing legs to windsweep and the trunk and head to face forward improves upper limb function and social inclusion.

HARNESSES



The chest pad can be used for individuals who need a little more thoracic support.



The chest harness for users who require more thoracic support to maintain stability for improved function.



The chest harness, which can be used indoors, or for additional support during transportation, is available in 3 sizes.

COMMUNICATION DEVICES



The KIT Seat has been designed to enable a range of communication devices to be easily attached. As the KIT Seat tilts or is height adjusted, the communications device moves too.



The shoulder protraction system improves hand control for using communications device.

POSTURE, FUNCTION & COMFORT

COMFORT

Comfort is integral to sustaining a functional posture as it reduces unwanted movement which can occur when users are uncomfortable. This becomes even more significant in the teenage and adult age groups, when users are likely to be heavier, less mobile, and spend much longer periods of time in their seating systems. Reducing unnecessary pressure areas is key to maintaining healthy skin. The KIT Seating System has a choice of two high grade pressure relieving cushions: Castellated Foam and Visco Elastic Memory Foam.

All foam cushions are sealed with water resistant Platilon® liners. In addition there are welded polyurethane covers available which can be washed at 90°C meeting the most stringent infection control guidelines.

Both cushions come with a choice of two fabric options:

1. The comfort cushion cover option is a two-way stretch, breathable, soft touch fabric. The cover is flame retardant and can be removed and washed at 40°C.

2. The infection control cushion cover option is a two-way stretch, antibacterial fabric with welded seams. The cover is flame retardant and can be removed and washed at 90°C.



CASTELLATED FOAM WHICH CONTOURS TO THE USER'S SHAPE

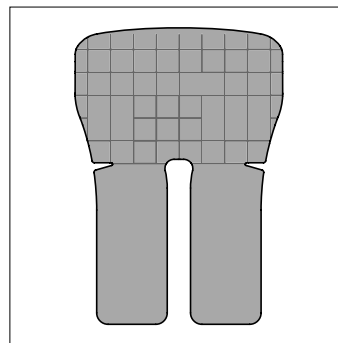
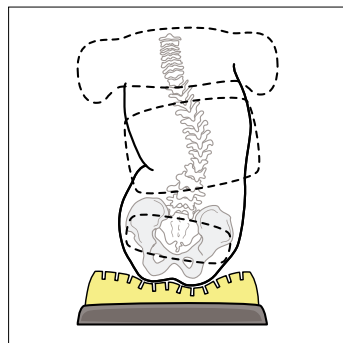
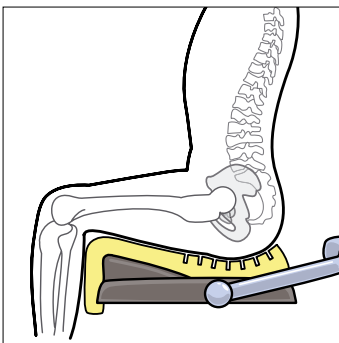

Castellated foam - the top surface of the area of foam under the ITs is cut into a grid pattern to allow the cushion to contour to the user's shape more easily.

VISCO ELASTIC MEMORY FOAM WELL TO PROVIDE OPTIMUM PRESSURE DISTRIBUTION

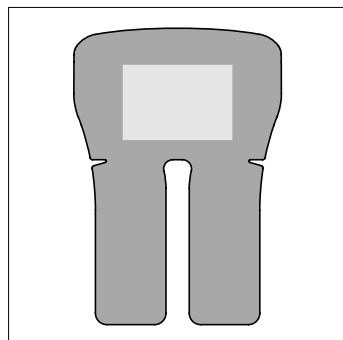
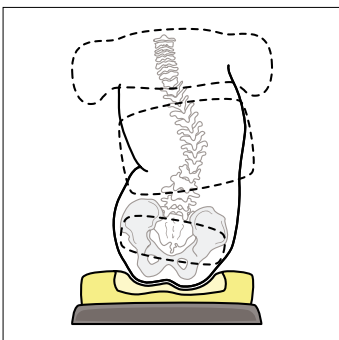

Visco elastic - an area of memory foam is inserted into the standard foam under the ITs to allow the user to submerge for optimum pressure distribution.

KIT SEATING SYSTEM

TO CONFIGURE THE KIT SEATING SYSTEM TO AN INDIVIDUAL'S NEEDS PLEASE CALL OUR CUSTOMER SERVICES TEAM TO ARRANGE AN ASSESSMENT:

**0800 318 265 (UK)
1800 626 020 (ROI)**

| PRODUCT SIZING | SIZE 1 | | SIZE 2 | |
|--|--|-------------|-----------------|-------------|
| | MM | INCHES | MM | INCHES |
| AGE RANGE | 12-18 Yrs | | 16-Adult | |
| STATURE RANGE | | | | |
| MIN | 1400 | 55.1 | 1600 | 63.0 |
| MAX | 1650 | 63.0 | 1850 | 70.9 |
| MAX USER WEIGHT (KG/LBS) | 75 | 165.0 | 75 | 165.0 |
| SEAT DEPTH | | | | |
| MIN | 360 | 14.2 | 410 | 16.1 |
| MAX | 480 | 18.9 | 560 | 22.0 |
| MAX WINDSWEEP ACCOMMODATION | 20° | 20° | 20° | 20° |
| MAX SEAT WIDTH - WITHOUT LATERALS | 430 | 16.9 | 430 | 16.9 |
| MAX SEAT WIDTH - WITH ARMREST SPACERS | 430 | 18.9 | 430 | 18.9 |
| SEAT WIDTH - WITH HIP LATERALS | | | | |
| MIN | 215 | 8.5 | 215 | 8.5 |
| MAX | 370 | 14.6 | 370 | 14.6 |
| BACKREST HEIGHT | | | | |
| MIN | 505 | 200 | 580 | 23.0 |
| MAX | 595 | 23.5 | 710 | 28.0 |
| SHOULDER WIDTH | | | | |
| MIN | 190 | 7.5 | 260 | 10.2 |
| MAX | 500 | 19.7 | 600 | 23.6 |
| CHEST WIDTH | | | | |
| MIN | 230 | 9.1 | 230 | 9.1 |
| MAX | 380 | 15.0 | 380 | 15.0 |
| BACKREST ANGLE | 90°-120° | 90°-120° | 90°-120° | 90°-120° |
| SEAT TO FOOTPLATE | | | | |
| MIN | 330 | 13.0 | 330 | 13.0 |
| MAX | 510 | 20.1 | 510 | 20.1 |
| ARMREST HEIGHT | | | | |
| MIN | 190 | 7.5 | 165 | 6.5 |
| MAX | 290 | 11.4 | 265 | 10.4 |
| TRAY SIZE | 630 x 460 | 24.8 x 18.1 | 630 x 460 | 24.8 x 18.1 |
| SEAT WEIGHT (SEAT & BACK) | 20.5 KG | 45.1 LBS | 21 KG | 46.2 LBS |
| KIT HI-LOW CHASSIS | | | | |
| TOP OF SEAT TO FLOOR | MIN 460MM / 18 INCHES MAX 640MM / 25 INCHES | | | |
| WITH HANDLE FOLDED DOWN | LENGTH 700MM / 27.6 INCHES WIDTH 620MM / 24.4 INCHES HEIGHT 410MM / 16 INCHES | | | |
| TILT IN SPACE | 10° prone - 30° supine | | | |

SEAT SHELL



133-1600 Size 1 seat shell assembly with fixed back rest spine

133-1600-REM Size 1 seat shell assembly with removable back rest spine



139-2600 Size 1 seat shell assembly with fixed back rest spine

139-2600-REM Size 1 seat shell assembly with removable back rest spine



Castellated foam seat base cushion & cover

133-404* Size 1 **139-404*** Size 2

Memory foam seat base cushion & cover

133-405* Size 1 **139-405*** Size 2

Seat shell comes as standard with

- seat base assembly
- upper leg guides and ramps
- backrest spine
- chassis interface mechanism

INTERCHANGEABLE BACKREST OPTIONS



Shoulder support assembly

133-611 Size 1 **139-611** Size 2

Shoulder support cushion & cover

133-400* Size 1 **139-400*** Size 2



133-605 Thoracic support assembly

133-401* Thoracic cushion & cover



Thoracic angle adjustable laterals

133-605 Thoracic support assembly

133-619 Laterals hardware

133-402* Cushion and cover



133-612 Sacral support assembly

133-403* Sacral cushion & cover



133-604 Size 1 contoured sacral support

133-400* Size 1 contoured sacral cushion & cover

COLOUR OPTIONS

When specifying accessories marked with * add the correct code for your colour selection:

+ 10 Blue + 11 Grey + 12 Purple + 13 Infection Control



Blue - 10

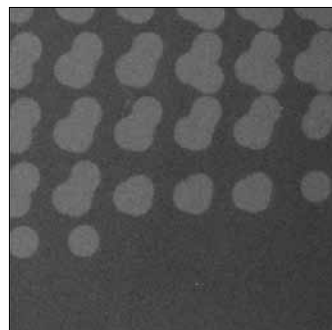

Grey - 11



Purple - 12

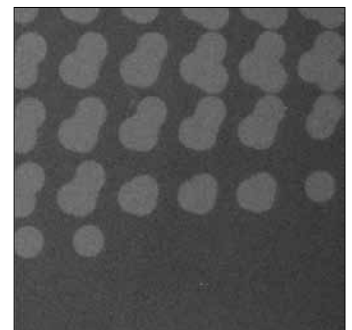

Grey (Infection Control) - 13

LECKEY SERVICING

Our FREE service and support includes:

- Free product training
- Free product set up
- Free product assessment
- Free product re-assessment
- Free repair within 2 year warranty

For service policies on all products outside warranty, please contact Leckey's Customer Service department. James Leckey Design Ltd as manufacturer with sole responsibility declares that all products conform to 93/42/EEC guidelines and EN12182 technical aids for disabled persons general requirements and test methods. Order forms and spare parts lists to extend the service life of the product and allow reissue are available on request or online at www.leckey.com.

ACCESSORIES



133-728 Pelvic Cradle Size 0
133-729 Pelvic Cradle Size 1
133-730 Pelvic Cradle Size 2
133-731 Pelvic Cradle Size 3



133-608 Hip lateral pads (Pair) (With cover)



133-737 Pelvic Cradle gluteal ramp



133-609 Flip away laterals (Single without covers)
133-747 Lateral Covers (Single)



133-622-LH Flipaway Laterals Complex Horizontal Left Hand (single with covers)
133-622-RH Flipaway Laterals Complex Horizontal Right Hand (single with covers)

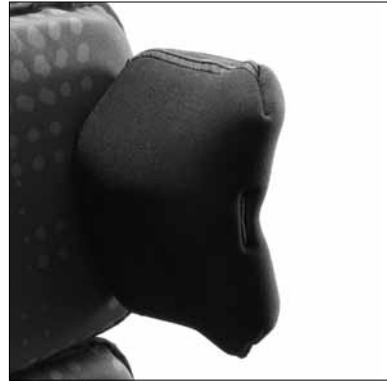

133-614-LH Flipaway Laterals Complex Vertical Left Hand (single with covers)
133-614-RH Flipaway Laterals Complex Vertical Right Hand (single with covers)



133-619 Thoracic cushion with angle adjustable laterals (Laterals hardware only)
133-402* Cushion and covers



133-625 Chest pad



133-1626 Chest harness size 1
133-2626 Chest harness size 2
133-3626 Chest harness size 3



133-1620 Lateral headrest



133-736 Armrests (Pair)



133-2147 Armrest Spacers



133-680 Padded tray insert



133-2145 Tray - Clear (For use with extended armrests)
133-2146 Tray - Black (For use with extended armrests)
133-635 Tray - Clear
133-624 Tray - Black



133-721 Leg straps (Pair)



133-682 Large femoral gables - Left
133-686 Large femoral gables - Right
133-683 Small femoral gables - Left
133-687 Small femoral gables - Right



133-1005 Foam spacer pack



133-606 Foot supports - Ball and socket joints (Pair)
133-607 Foot supports - Basic (Pair)



133-712 Sandal straps size 1
133-742 Sandal straps size 2



133-1021 Femoral spacers (1")
133-1012 Femoral spacers (2")



133-638 Footplates with 50mm lateral adjustment

CHASSIS & MOBILITY INTERFACE OPTIONS



KIT Hi-low base
133-750 Hydraulic
133-760 Powered



133-740 45cm Discovery base and mobility interface A



133-726 45cm Discovery Interface A
133-790 Interface A for 45cm/18" bases (not shown)
133-781 45cm Discovery interface for Otto Bock B400

LECKEY^o

Established in 1983, Leckey is a globally recognised pioneer in the research and development of products that help adults and children with disabilities to go, do, enjoy and participate in everyday activities throughout the day and night.

We take a highly clinical approach to product design and development. Through in-depth clinical research studies with leading universities, and extensive trials with occupational therapists, physiotherapists, users and their families, we continue to develop posturally supportive, family friendly products for all day care, at every stage of life.

Through early intervention, childhood and adulthood Leckey's experienced team of designers, therapists and bioengineers work together to develop products that meet the clinical needs of the healthcare professionals and the social needs of the user.

To achieve this, we work with the healthcare professionals, the individuals and carers who use our products everyday. With their help, we create the dependable, durable, proven and high performance products that we are known for worldwide.





24 hour postural
care for babies,
kids & adults.
Sleeping, Sitting,
Standing, Walking,
Moving, Bathing,
Toileting.