

Short Instruction

IMM1024a_SI.VER17.2022-05-16



	Article no.	Description	Size (mm)
	IM4133S	SatinSheet 2Direction mini - small	W1950xL1050 (satin W600xL1050)
	IM4108S	SatinSheet 2Direction mini	W1950xL1050 (satin W700xL1050)
	IM4175S	SatinSheet 2Direction mini - wide	W2300xL1050 (satin W850xL1050)
	IM4178S	SatinSheet 2Direction mini - double	W2300xL1050 (satin W960xL1050)
	IM4119S	SatinSheet 2Direction midi - small	W2000xL1400 (satin W600xL1400)
	IM4113S	SatinSheet 2Direction midi	W2000xL1400 (satin W700xL1400)
	IM4176S	SatinSheet 2Direction midi - wide	W2300xL1400 (satin W850xL1400)
	IM4179S	SatinSheet 2Direction midi - double	W2300xL1400 (satin W960xL1400)
	IM4181S	SatinSheet 2Direction maxi - small	W2000xL2000 (satin W600xL2000)
	IM4114S	SatinSheet 2Direction maxi	W2000xL2000 (satin W700xL2000)
	IM4177S	SatinSheet 2Direction maxi - wide	W2300xL2000 (satin W850xL2000)
	IM4180S	SatinSheet 2Direction maxi - double	W2300xL2000 (satin W960xL2000)
	IM4122S	SatinSheet 2Direction 180 cm bed	W2800xL2000 (satin W600xL2000)
Combination:	IM4116S	SatinSheet DrawSheet - mini	W2000xL1000
	IM4118S	SatinSheet DrawSheet - midi	W2000xL1400
	IM4115S	SatinSheet 4Direction - midi	W2000xL1400 (satin W1470xL1400)
	IM4115SH	SatinSheet 4Direction w/handles - midi	W2000xL1400 (satin W1470xL1400)
	IM4121S	SatinSheet 4Direction - maxi	W2000xL2000 (satin W1470xL2000)
	IM4121SH	SatinSheet 4Direction w/handles - maxi	W2000xL2000 (satin W1470xL2000)
	IM4110S	In2Sheet 4Direction w/wings - mini	W850xL900
	IM4110SH	In2Sheet 4Direction w/wings + handles - mini	W850xL900
	IM4140S	In2Sheet 4Direction w/wings - midi	W1200xL1400
	IM4140SH	In2Sheet 4Direction w/wings + handles - midi	W1200xL1400
	IM4117S	SatinSheet 2Direction PillowCase	W700xL600 (satin W700xL600)

Set: Combinations, PLEASE see Instruction For Use , catalogue or web.

SatinSheet 2Direction BaseSheet

immedia
by Etac

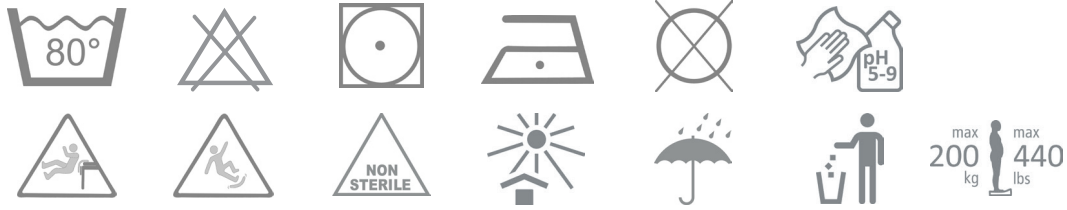

GB:

Material:

Polycotton: 50% cotton/50% polyester
Satin: Polyester.

**Never try to repair a product yourself.
Never use a defective product.**

Washing instructions:

Ironing improves the glide effect. Do not use fabric softener. Recommended to wash the product before use. This product can be cleaned with a solvent-free cleaning agent with a pH level between 5-9, or a 70% disinfection solution. The product should be checked regularly, preferably each time it is used and especially after wash. Check that there is no damage to seams or fabric.

SV:

Material:

Poly/bomull: 50% bomull / 50% polyester
Satin: Polyester.

**Försök aldrig reparera en produkt själv.
Använd aldrig en defekt produkt.**

Tvättinstruktioner:

Strykning förbättrar glideeffekten. Använd inte sköljmedel. Det rekommenderas att produkten tvättas före användning. Produkten kan rengöras med rengöringsmedel utan lösningsmedel och med pH-värde 5-9 eller med 70 % tvättsprit.

Produkten bör kontrolleras regelbundet, helst varje gång den har använts och särskilt efter tvätt. Kontrollera att sömmar och tyg inte är skadade.

NO:

Materiale:

Polybomull: 50 % bomull, 50 % polyester
Sateng: Polyester.

**Du må aldri forsøke å reparere produktet selv.
Hvis produktet er defekt, må det ikke brukes.**

Vaskeinstruks:

Stryking gir bedre glideeffekt. Ikke bruk tøymykner. Det anbefales å vaske produktet før bruk. Produktet kan vaskes med et løsemiddelfritt rengjøringsmiddel med pH mellom 5 og 9, eller desinfiseres med 70 % konsentrasjon.

Produktet skal kontrolleres regelmessig, fortrinnsvis ved hver bruk, og ekstra nøye etter vask. Kontroller at sømmer og stoff ikke er skadet.

DA:

Materiale:

Polycotton: 50 % bomuld/50 % polyester
Satin: Polyester.

**Reparér aldrig selv et produkt.
Et defekt produkt må ikke anvendes.**

Vaskeinstruktion:

Strygning forbedrer glideevnen. Tilsæt ikke skyllemiddel. Det anbefales at vaske produktet før brug. Produktet kan rengøres med et opløsningsmiddelfrit rengøringsmiddel med et pH-niveau mellem 5-9 eller med 70 % desinfektionsopløsning.

Produktet skal kontrolleres regelmæssigt, helst hver gang før brug. Vær specielt omhyggelig efter vask. Kontrollér at der ikke er skader ved sømme og stof.

FI:

Materiaali:

Polypuuvilla: 50 % puuvillaa / 50 % polyesteriä
Satiini: Polyesteriä.

**Älä koskaan yritä korjata tuotetta itse.
Viallista tuotetta ei saa käyttää.**

Pesuohjeet:

Silitäminen parantaa liukuominaisuuksia. Älä käytä huuhteluainetta. Tuotteen pesu ennen käyttöä on suositeltavaa. Tuote voidaan puhdistaa pesuaineella, joka ei sisällä liuottimia ja jonka pH on 5-9, tai 70-prosenttisella desinfiointiaineella.

Tuote on tarkistettava säännöllisesti, mieluiten joka kerta kun sitä käytetään ja erityisesti pesun jälkeen. Tarkista, ettei saumoissa tai kankaassa ole vaurioita.

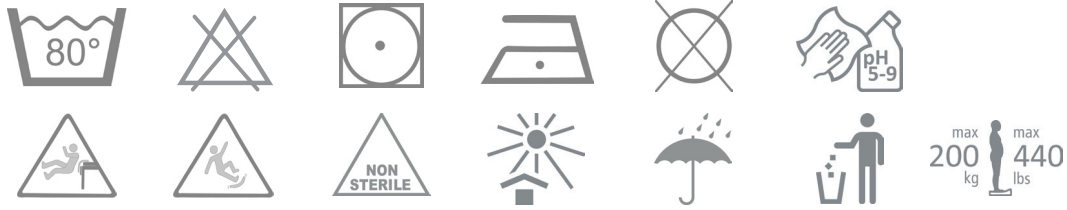

DE:

Material:

Poly-Baumwolle: 50 % Baumwolle und 50 % Polyester
Satin: Polyester.

**Niemals versuchen, ein Produkt eigenhändig zu reparieren.
Verwenden Sie niemals ein defektes Produkt.**

Waschanleitung:

Bügeln verstärkt den Gleiteffekt. Keinen Weichspüler verwenden.
Es ist empfehlenswert, dass Produkt vor der ersten Nutzung zu waschen.
Das Produkt kann mit einem lösungsmittelfreien Mittel mit einem pH-Wert von 5-9 oder einer 70%igen Desinfektionslösung gereinigt werden.

Das Produkt sollte regelmäßig überprüft werden, möglichst bei jeder Verwendung und vor allem nach dem Waschen. Es ist sicherzustellen, dass an Nähten oder im Stoff keinerlei Schäden vorliegen.

NL:

Material:

Polykatoen: 50% katoen/50% polyester
Satin: Polyester.

**Probeer een product nooit zelf te repareren.
Gebruik nooit een defect product.**

Wasinstructies:

Strijken verbetert het glijeffect. Geen wasverzachter toevoegen.
We adviseren om het product voor gebruik te wassen.
Dit product kan ook worden gereinigd met een reinigingsmiddel dat geen oplosmiddel bevat en een pH-waarde tussen 5 en 9 heeft. U kunt ook een ontsmettingsmiddel met een concentratie van 70% gebruiken.

Het product moet regelmatig worden gecontroleerd, bij voorkeur voor elk gebruik, en met name na het wassen. Controleer op schade aan de naden en de stof.

FR:

Matériaux :

Polycoton : 50 % coton / 50 % polyester
Satin : Polyester.

**N'essayez jamais de réparer un produit vous-même.
N'utilisez jamais un produit défectueux.**

Instructions de lavage :

Repasser améliore l'effet de glisse. Ne pas ajouter d'adoucissant.
Il est conseillé de laver le produit avant son utilisation.
Le produit peut être nettoyé avec un agent nettoyant sans solvant, de pH compris entre 5 et 9, ou une solution désinfectante diluée à 70 %.

Le produit doit être vérifié régulièrement, de préférence chaque fois qu'il est utilisé, et surtout après un lavage. Vérifiez qu'il n'y a aucun dommage au niveau des coutures ou du tissu.

IT:

Materiale:

Policotone: 50% cotone, 50% poliestere
Raso: Poliestere.

**Non tentare mai di riparare un prodotto da soli.
Non utilizzare mai un prodotto difettoso.**

Istruzioni di lavaggio:

La stiratura migliora l'effetto di scorrimento. Non aggiungere ammorbidente. Si consiglia di lavare il prodotto prima dell'uso.
Lavare il prodotto utilizzando un detergente privo di solventi con pH compreso tra 5 e 9 oppure una soluzione disinfettante al 70%.

Controllare il prodotto regolarmente, preferibilmente ogni volta che viene utilizzato e in particolare dopo il lavaggio. Controllare che non vi siano lacerazioni alle cuciture o al tessuto.

ES:

Material:

Polialgodón: 50 % algodón / 50 % poliéster.
Raso: 100 % poliéster.

**No intente reparar usted mismo el producto.
No utilice nunca un producto defectuoso.**

Instrucciones de lavado:

El planchado mejora el efecto deslizante. No utilizar suavizante.
Se recomienda lavar el producto antes de usarlo.
El producto se puede limpiar con un agente limpiador sin disolventes con un nivel de pH entre 5-9, o una solución de desinfección al 70 %.

El producto debería revisarse con regularidad, preferentemente cada vez que se use y, especialmente, después de haberlo lavado. Compruebe que las costuras o el tejido no estén dañados.

Illustrations

Positioning different sizes of SatinSheet BaseSheet 2Direction on a mattress

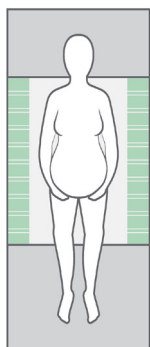

100 x 200 cm

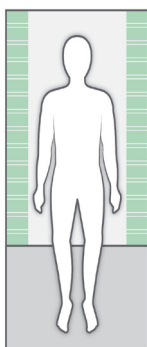

140 x 200 cm

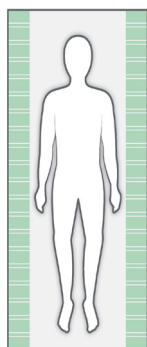

200 x 200 cm

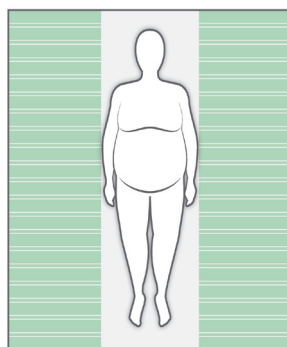

230 x 200 cm

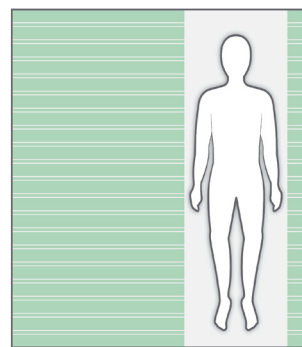

280 x 200 cm

Positioning different sizes of SatinSheet DrawSheet placed correct on top of SatinSheet 2Direction

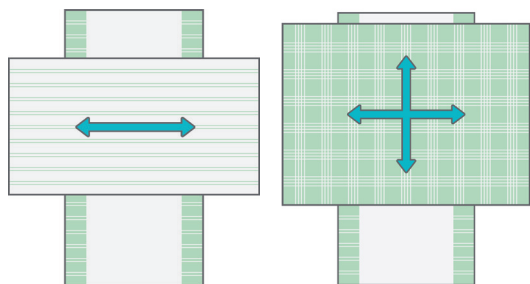

1

2

3

4

Check



Instruction for use

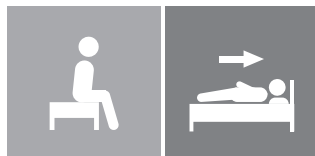

IMM1025_IFU.Version16.2022-05-17



SatinSheet 4Direction

immedia
by Etac

Index

Illustrations	3
User manual - English	4
Bruksanvisning - Svenska.....	10
Bruksanvisning - Norsk.....	16
Brugervejledning - Dansk.....	22
Käyttöohjeet - Suomi.....	28
Gebrauchsanweisung - Deutsch	34
Gebruiksaanwijzing - Nederlands.....	40
Instruction d'utilisation - Francais....	46
Istruzioni per l'uso - Italiano	52
Instrucciones de uso - Español	58

See www.etac.com



Illustrations

Positioning different sizes of SatinSheet BaseSheet 2Direction on a mattress

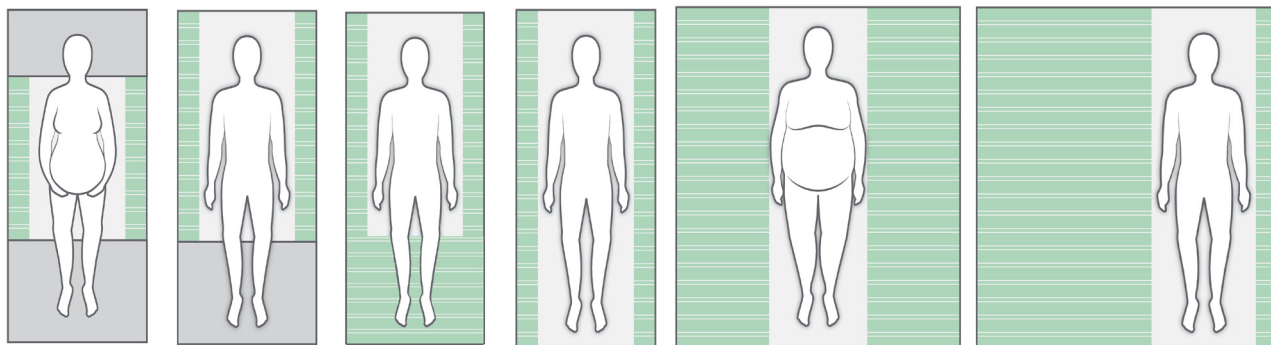

100 x 200 cm

140 x 200 cm

85 x 200 cm

200 x 200 cm

230 x 200 cm

280 x 200 cm

Positioning different sizes of SatinSheet DrawSheet placed correct on top of SatinSheet 2Direction

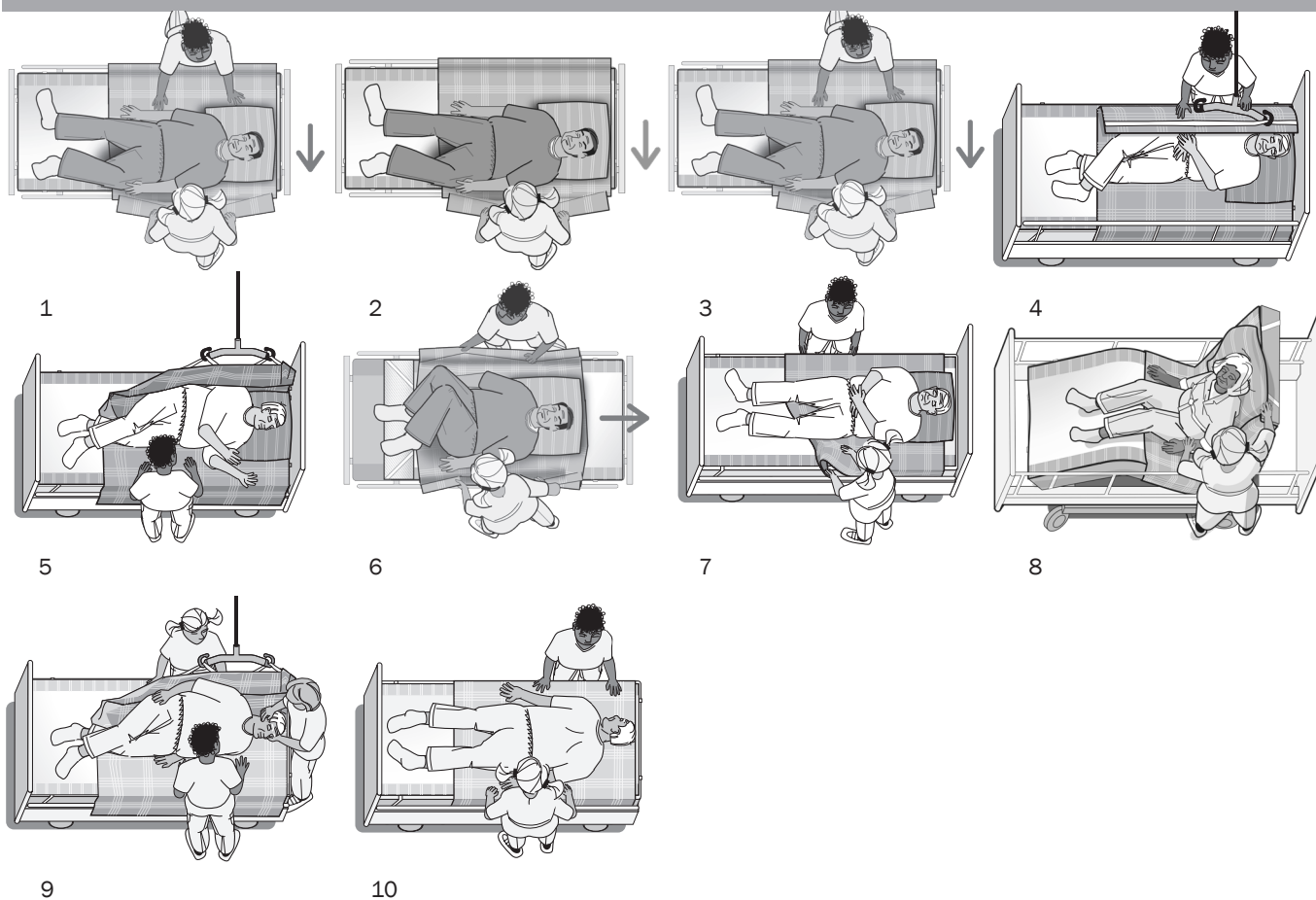
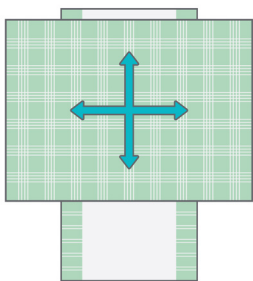

1

2

3

4

5

6

7

8

9

10

General

Thank you for choosing an Etac product.

To avoid accidents and injury when moving and handling the products, please read this manual carefully.

The person described as “the user” in this “Instruction for Use” is the person who is lying or sitting on the product. The carers are the people who manoeuvre the product.



This symbol appears alongside the text in the manual. It draws the reader’s attention to points at which there may be a risk to the health and safety of the user or carer.

These products comply with the standards applicable for Class 1 products in the Medical Device Regulation (EU) 2017/745 on medical devices.

At Etac we strive to continually improve our products and therefore we reserve the right to make changes to products without prior warning. All measurements given on illustrations and similar material are for guidance only and Etac cannot be held liable for errors and defects.

The information given in this manual, including recommendations, combinations and sizing, does not apply to special orders and modifications. If the customer makes adjustments, repairs or uses combinations not predetermined by Etac, the Etac CE certification and Etac warranty will not be valid. If in doubt, please contact Etac.

Warranty: Two-year warranty on material and manufacturing defects, provided that the product is used correctly.

Expected lifetime: The device has an expected service life of 1 to 2 years under normal use. The service life of the device varies depending on usage frequency, loads and how often and how it is washed.

For further information on the Etac Patient handling, see www.etac.com.

In case of an adverse event occurred in relation to the device, incidents should be reported to your local dealer and the national competent authority in a timely manner. The local dealer will forward information to manufacturer.

Symbols in general



Washing



Disinfect / Wipe off



Warning



Manufacturer



Do not bleach



Never leave on the floor



Production year, month and day



CE -marked



Tumbledry



Risk of sliding down



Batch no./Lot no.



Keep dry



Iron



Keep out of the sun



User mass limit = maximum rated load



Non sterile



Do not dryclean



Read the user manual



The product can be scrapped according to national regulations



Article number



Medical device

Intended purpose

SatinSheet 4Direction is a DrawSheet for use with BaseSheet (SatinSheet BaseSheet 2Direction). The SatinSheet system is used for repositioning and turn a user in bed.

Intended environment

Acute care, Long-term care, Home care

Practical handling

Positioning

Position SatinSheet BaseSheet with the low-friction material (satin) uppermost in the middle of the bed (Illustrations). If necessary, a draw sheet can be laid on SatinSheet. All SatinSheet models have a "this side up" label indicating which side of the sheet should face upwards in the bed. An information label, describing the correct use of the product, is sewn into all SatinSheet models/products.

Place SatinSheet 4Direction on BaseSheet (satin against satin).

Before locking the glide system under the mattress, any unevenness/wrinkles should be smoothed to avoid decubitus. The carers pull simultaneously and diagonally from both sides.

Use

Turning with SatinSheet 4Direction (Illustrations 1-3)

Always use SatinSheet 4Direction with one of the SatinSheet models.

The back of SatinSheet 4Direction is made of a low-friction material. It is ideal for use with bariatric users. The procedure for turning with SatinSheet 4Direction is identical with the procedure for turning with SatinSheet and a draw sheet. To turn a user in bed: Grasp the draw sheet at hips and shoulders. To achieve a better ergonomic grip, the carer should grasp as much fabric as possible.

Always work with flat wrists and weight transference. Turning with SatinSheet can also be done by two carers. The carers work together. One carer helps pull on SatinSheet while the other carer pulls down on the mattress at the level of the user's hips and shoulders, pushing gently.

If using SatinSheet 4Direction with handles you can turn the user with a hoist. Place the webbing handles on the sling bar hooks and slowly turn the user (Illustrations 4+5). Place a positioning pillow or wedge to support the user's back and slowly lower the hoist again. Remove the handles from the sling bar hooks. Raise the guard rails if required.

Turn the user.
To lock the glide system after turning: Fold the excess material from DrawSheet under the mattress on both sides of the bed.

Moving the user higher up in the bed (Illustration 6)

To move the user higher up in the bed, grasp SatinSheet 4Direction at both sides of the user's shoulders. Standing with one foot forward, the carer pulls, using weight transference.

Sitting up in bed with SatinSheet 4Direction (Illustrations 7+8)

To prevent the user sliding down in the bed when sitting up, part

of SatinSheet 4Direction can be folded in under the user. Then fold SatinSheet in under the mattress, although only at the hips. The bed headboard can then be raised. SatinSheet functions here as a brake.

Prone positioning

Remove the head-end of the bed. If the user is connected to a ventilator or other life saving machines, turn the user towards the equipment. Place the hand of the user under the hip. If needed add 2-3 pillows or positioning cushions used on top of the users body. Place a SatinSheet4Direction on the pillows with the satin facing upwards, starting at the head end - fold the 4Direction away from the users head. Tug the SatinSheet4Direction top around the user like a cocoon. Fold the lower 4Direction away from the users head (satin against satin)
One carer secures the head of the user and one carer on each side to support the user.
Move the user to the opposite side to where the user is turned. Place the webbing handles from the SatinSheet4Direction which the user lay on in the sling bar hooks and slowly turn the user to almost 90° (Illustrations 9) Push and pull in the SatinSheet4direction, to secure the rotation is a bit of center. When user is on the side one carer tug the SatinSheet4Direction on the bed under the user to be able to remove it when the user is turned to prone. Same carer support the user by having the hands on the shoulder. Continue to turn the user until the user is in a proned position. Lower the hoist again. Remove the handles from the sling bar hooks and remove the SatinSheet4Direction. Unfold the 4Direction under the users head. If necessary move the user to the center of the bed. Secure that the user is correct positioned. (illustration 10) Raise the bed rails if required. Turn to supine positioning the same way.

Notice

Special features

Always check the product before use and after washing.

Never use a defective product. If the product shows signs of wear-and-tear, it must be scrapped.

Read these instructions carefully.

It is important that carers receive instruction in manual handling. Etac offers advice and training for carers. For further information, contact Etac.

Always use the correct manual handling techniques

Encourage the user to assist where possible.

To ensure that the user feels safe and that every manual handling is smooth, always plan the manual handling in advance.



There is a risk that the user may slide off. Never leave the user alone on the edge of the bed.



Never leave the product on the floor.



Always conduct a risk assessment, and ensure that the assistive product can be used for the individual user and, in combination with other devices, that it is safe for the user and carers.



It is recommended that the guard rail is in place when the user is left on the glide system, unless a risk assessment has found that the user can be safely left on the glide system without the need of guard rails.



Always lock the glide system when you have completed the transfer.

If in any doubt - please contact Etac.

Material and cleaning

Material:

SatinSheet 4Direction:

Polycotton: 55% cotton/45% polyester

Satin: Polyester.

SatinSheet In2Sheet 4Direction:

Microfibre top side: Polyester

Middle layer: 65% polyester/35% viscose

Barrier: Polyurethane

Glide area: Polyester

Handles: Nylon

Wings: 55% cotton/45% polyester.

Absorption: 2200 ml/m².

The product should be checked regularly, preferably each time it is used, and especially after washing.

Check that there is no damage to seams or fabric.



**Never try to repair a product yourself.
Never use a defective product.**



Recommended to wash the product before use.

Washing instructions:

Ironing improves the glide effect.

Do not use fabric softener.

This product can be cleaned with a solvent-free cleaning agent with a pH level between 5 and 9, or a 70% disinfection solution.



Products and accessories

Article no.	Product Description	Size (mm)
IM4115S	SatinSheet 4Direction - midi (satin W1470xL1400 mm)	W2000xL1400
IM4115SH	SatinSheet 4Direction w/handles - midi (satin W1470xL1400)	W2000xL1400
IM4121S	SatinSheet 4Direction - maxi (satin W1470xL2000 mm)	W2000xL2000
IM4121SH	SatinSheet 4Direction w/handles - maxi (satin W1470xL2000)	W2000xL2000
IM4131SH	SatinSheet 4Direction w/handles maxi - wide	W3000xL2000
IM4110S	In2Sheet 4Direction w/wings - mini	W850xL900
IM4110SH	In2Sheet 4Direction w/wings + handles - mini	W850xL900
IM4140S	In2Sheet 4Direction w/wings - midi	W1200xL1400
IM4140SH	In2Sheet 4Direction w/wings and handles - midi	W1200xL1400

Set

Article no.	Description	SatinSheet 2Direction BaseSheet	SatinSheet DrawSheet and SatinSheet 4Direction
IM4200S	SatinSheet DrawSheet midi set	IM4113S SatinSheet 2Direction midi	IM4118S SatinSheet DrawSheet - midi
IM4201S	SatinSheet DrawSheet mini set	IM4108S SatinSheet 2Direction mini	IM4116S SatinSheet DrawSheet - mini
IM4202S	SatinSheet DrawSheet maxi midi set	IM4114S SatinSheet 2Direction maxi	IM4118S SatinSheet DrawSheet - midi
IM4203S	SatinSheet 4Direction Fit midi set	IM4112S SatinSheet 2Direction FIT	IM4115S SatinSheet 4Direction - midi
IM4204S	SatinSheet 4Direction midi set	IM4113S SatinSheet 2Direction midi	IM4115S SatinSheet 4Direction - midi
IM4205S	SatinSheet DrawSheet midi small set	IM4119S SatinSheet 2Direction midi small	IM4118S SatinSheet DrawSheet - midi
IM4207S	SatinSheet 4Direction midi small set	IM4119S SatinSheet 2Direction midi small	IM4115S SatinSheet 4Direction - midi
IM4208S	SatinSheet Corner DrawSheet midi set	IM4107S SatinSheet 2Direction w/elastic	IM4118S SatinSheet DrawSheet - midi
IM4209S	SatinSheet In2Sheet midi mini set	IM4119S SatinSheet 2Direction midi small	IM4110S In2Sheet 4Direction w/wings - mini
IM4210S	SatinSheet In2Sheet mini set	IM4108S SatinSheet 2Direction mini	IM4110S In2Sheet 4Direction w/wings - mini
IM4211S	SatinSheet Corner 4Direction midi set	IM4107S SatinSheet 2Direction w/elastic	IM4115S SatinSheet 4Direction - midi
IM4212S	SatinSheet Corner 4Direction maxi set	IM4107S SatinSheet 2Direction w/elastic	IM4121S SatinSheet 4Direction - maxi
IM4213S	SatinSheet 4Direction maxi set	IM4114S SatinSheet 2Direction maxi	IM4121S SatinSheet 4Direction - maxi
IM4214S	SatinSheet 4Direction maxi set - wide	IM4177S SatinSheet2direction maxi - wide	IM4121S SatinSheet 4Direction - maxi
IM4215S	SatinSheet 4Direction maxi set - double	IM4180S SatinSheet 2Direction maxi - double	IM4121S SatinSheet 4Direction - maxi
IM4216S	SatinSheet 4Direction midi set - wide	IM4176S SatinSheet2direction midi - wide	IM4115S SatinSheet 4Direction - midi
IM4217S	SatinSheet 4Direction midi set - double	IM4179S SatinSheet2direction midi - double	IM4115S SatinSheet 4Direction - midi
IM4218S	SatinSheet 4Direction maxi midi set	IM4114S SatinSheet 2Direction maxi	IM4115S SatinSheet 4Direction - midi
IM4219S	SatinSheet 4Direction maxi midi set - wide	IM4177S SatinSheet2direction maxi - wide	IM4115S SatinSheet 4Direction - midi
IM4220S	SatinSheet 4Direction maxi midi set - double	IM4180S SatinSheet 2Direction maxi - double	IM4115S SatinSheet 4Direction - midi
IM4221S	SatinSheet DrawSheet maxi midi set - wide	IM4177S SatinSheet2direction maxi - wide	IM4118S SatinSheet DrawSheet - midi
IM4222S	SatinSheet DrawSheet maxi midi set - double	IM4180S SatinSheet 2Direction maxi - double	IM4118S SatinSheet DrawSheet - midi
IM4223S	SatinSheet DrawSheet midi set - wide	IM4176S SatinSheet2direction midi - wide	IM4118S SatinSheet DrawSheet - midi
IM4224S	SatinSheet DrawSheet midi set - double	IM4179S SatinSheet2direction midi - double	IM4118S SatinSheet DrawSheet - midi
IM4225S	SatinSheet Corner 4Direction midi set - wide	IM4147S SatinSheet 2Direction w/elastic-wide	IM4115S SatinSheet 4Direction - midi
IM4226S	SatinSheet Corner 4Direction midi set - double	IM4137S SatinSheet 2Direction w/elastic-double	IM4115S SatinSheet 4Direction - midi
IM4227S	SatinSheet Corner DrawSheet midi set - wide	IM4147S SatinSheet 2Direction w/elastic - wide	IM4118S SatinSheet DrawSheet - midi
IM4228S	SatinSheet Corner DrawSheet midi set - double	IM4137S SatinSheet 2Direction w/elastic-double	IM4118S SatinSheet DrawSheet - midi
IM4229S	SatinSheet Corner 4Direction maxi set - wide	IM4147S SatinSheet 2Direction w/elastic - wide	IM4121S SatinSheet 4Direction - maxi
IM4230S	SatinSheet Corner 4Direction maxi set - double	IM4137S SatinSheet 2Direction w/elastic - double	IM4121S SatinSheet 4Direction - maxi
IM4231S	SatinSheet Corner 4Direction w/handle midi set	IM4107S SatinSheet 2Direction w/elastic	IM4115SH SatinSheet 4Direction w/handles- midi
IM4251S	SatinSheet 4Direction maxi midi set - small		

Combinations

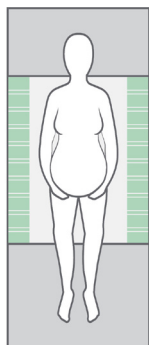

Article no. BaseSheet - Mini

IM4133S	SatinSheet 2Direction mini - small
IM4108S	SatinSheet 2Direction mini
IM4175S	SatinSheet 2Direction mini - wide
IM4178S	SatinSheet 2Direction mini - double

BaseSheet - Mini can be combined with:

Article no. DrawSheet, 4Direction and PillowCase

IM4116S	SatinSheet drawSheet - mini
IM4110S	In2Sheet 4Direction w/wings - mini
IM4110SH	In2Sheet 4Direction w/wings + handles - mini
IM4117S	SatinSheet 2Direction PillowCase

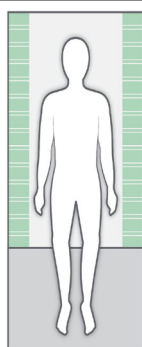

Article no. BaseSheet - Midi

IM4119S	SatinSheet 2Direction midi small
IM4113S	SatinSheet 2Direction midi
IM4176S	SatinSheet 2Direction midi - wide
IM4179S	SatinSheet 2Direction midi - double

BaseSheet - Midi can be combined with:

Article no. DrawSheet, 4Direction and PillowCase

IM4118S	SatinSheet DrawSheet - midi
IM4115S	SatinSheet 4Direction - midi
IM4115SH	SatinSheet 4Direction w/handles - midi
IM4121S	SatinSheet 4Direction - maxi
IM4121SH	SatinSheet 4Direction w/handles - maxi
IM4117S	SatinSheet 2Direction PillowCase

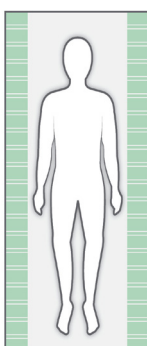

Article no. BaseSheet - Maxi

IM4181S	SatinSheet 2Direction maxi - small
IM4114S	SatinSheet 2Direction maxi
IM4177SH	SatinSheet 2Direction maxi - wide
IM4180S	SatinSheet 2Direction maxi - double
IM4122S	SatinSheet 2Direction 180cm bed

Article no. BaseSheet - Maxi Corner

IM4107S	SatinSheet 2Direction Corner
IM4147S	SatinSheet 2Direction Corner - wide
IM4137S	SatinSheet 2Direction Corner - double

Article no. BaseSheet - Maxi Fit

IM4112S	SatinSheet 2Direction Fit
IM4142S	SatinSheet 2Direction Elastic Fit

Article no. BaseSheet - Mini, Midi and Maxi Corner

IM4167S	SatinSheet 2Direction Corner - small -mini
IM4157S	SatinSheet 2Direction Corner - midi
IM4197S	SatinSheet 2Direction Corner - double - double - maxi

BaseSheet - Maxi/Corner/Fit can be combined with:

Article no. 4Direction and In2Sheet 4Direction

M4115S	SatinSheet 4Direction - midi
IM4115SH	SatinSheet 4Direction w/handles - midi
IM4140S	In2Sheet 4Direction w/wings - midi
IM4140SH	In2Sheet 4Direction - w/wings + handles - midi
IM4121S	SatinSheet 4Direction - maxi
IM4121SH	SatinSheet 4Direction w/handles - maxi

Remember SatinSheet PillowCase (2D)

IM4117S	SatinSheet 2Direction PillowCase
---------	----------------------------------

Service information

Inspection

First inspection:

- Is the packaging intact?
- Read the label on the packaging and check the article no. and product description
- Check that Short Instruction is enclosed – updated User Manual/Instruction for use can be downloaded from www.etac.com or contact your Etac Customer Service or the local dealer.
- Check the label on the product - does it include article no., product description, lot/batch no., cleaning instructions and supplier name?

Periodic Inspection:

- Make sure that your Manual transfer system always is in a perfect condition.
- After wash – always check materials, stitching, handles, buckles.
- If the product shows signs of wear and tear, it must be removed from service immediately.



Visual inspection/Check the product:

Ensure that the materials, seams, stitching, handles, buckles are intact/faultless.



Stability test:

Try to bend the product verify that it feels firm, stable and solid.



Mechanical load or stress/Test handles:

Draw hard in the handles in opposite directions and control the material, seams and stitching.

Test buckles:

Lock the buckle and draw in opposite directions, control the buckle and the stitching.



Test low/high friction:

Place the product on a firm surface or a bed, place your hands on the material and test the friction by pushing your hands down into the product.

Low friction – slides effortlessly

High friction – no sliding/moving

Check:

Manual transfer aids with handles, straps and buckles:

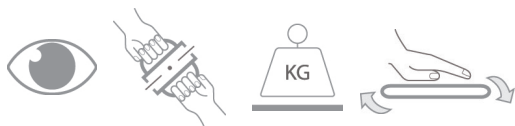

Manual transfer aids with for sitting and lying transfer and with high or low friction:



Production year, month and day



The product can be scrapped in accordance with national regulations



Read the user manual

Allmänt

Tack för att du har valt en produkt från Etac.

För att undvika olyckor och personskador vid hantering och användning av produkten bör du läsa igenom bruksanvisningen noga.

Den person som beskrivs som "brukaren" i dessa instruktioner är personen som ligger eller sitter på produkten. Hjälparna är de personer som manövrerar produkten.



Den här symbolen förekommer i manualen tillsammans med text. Den vill påkalla uppmärksamhet när brukarens eller hjälparens säkerhet kan äventyras.

Produkten uppfyller de standarder som gäller för klass 1-produkter reglering av medicintekniska enheter (EU) 2017/745 för medicinsk utrustning.

På Etac strävar vi efter att hela tiden förbättra våra produkter. Därför förbehåller vi oss rätten att göra ändringar av produkterna utan att meddela detta i förväg. Alla mått som anges på bilder och i liknande material är endast vägledande. Etac kan inte hållas ansvariga för felaktigheter och brister.

Informationen i dessa instruktioner, inklusive rekommendationer, kombinationer och storlekar, gäller inte för specialbeställningar och modifikationer. Om kunden gör några ändringar, reparationer eller kombinationer som inte har godkänts av Etac, upphör Etacs CE-certifiering och garanti att gälla. Kontakta Etac om du har några frågor.

Garanti: Två års garanti för material- och tillverkningsfel, under förutsättning att produkten används på rätt sätt.

Förväntad livslängd: Enheten har en förväntad livslängd på 1 till 2 år vid normal användning. Enhetens livslängd varierar beroende på användningsfrekvens, belastning och hur ofta och hur den rengörs.

Mer information om Etacs sortiment av förflyttningsprodukter finns på www.etac.com.

I händelse av en biverkning i samband med produkten ska incidenter rapporteras till din lokala återförsäljare och den nationella behöriga myndigheten i tid. Den lokala återförsäljaren vidarebefordrar information till tillverkaren.

Allmänna symboler



Tvätt



pH-nivå / Avtorkning



Varning



Tillverkare



Ingen blekning



Lämna aldrig på golvet



Tillverkningsdatum: år, månad och dag



CE-märkning



Torktumling



Nedglidningsrisk



Batchnr/partnr



Hålls torr



Strykning



Skydda från solljus



Största massa för brukare = maximal belastning



Icke steril



Ingen kemtvätt



Läs bruksanvisningen



Produkten kan avfallshandteras i enlighet med nationella bestämmelser



Artikelnummer



Medicinsk enhet

Avsett syfte

SatinSheet 4Direction är ett DrawSheet avsett för användning med ett BaseSheet (SatinSheet BaseSheet 2Direction). SatinSheet-systemet används för att flytta och vända en användare i sängen.

Avsedd miljö

Akutvård, långvarig vård och vård i hemmet.

Placering

Placera SatinSheet BaseSheet med materialet med låg friktion (satin) uppåt i mitten av sängen (bilder). Vid behov kan ett draglakan placeras över SatinSheet.

Alla SatinSheet-modeller har etiketten "denna sida upp" för att visa vilken sida av lakanet som ska vara vänt uppåt i sängen. En informationsetikett som beskriver korrekt användning av produkten är insydd i alla SatinSheet-modeller/produkter.

Placera SatinSheet 4Direction på BaseSheet (satin mot satin).

Innan glidsystemet låses under madrassen ska eventuella veck och ojämnheter rättas till för att undvika liggsår. Hjälparna drar samtidig diagonalt från båda sidor.

Användning

Vända med SatinSheet 4Direction (bild 1–3)

Använd alltid SatinSheet 4Direction tillsammans med en av SatinSheet-modellerna.

Baksidan av SatinSheet 4Direction är tillverkad i material med låg friktion. Hjälpmålet är idealiskt för bariatriska brukare. Metoden för att vända brukaren med SatinSheet 4Direction är likadan som för att vända med SatinSheet och ett draglakan. Så här vänder du en brukare i sängen: Ta tag i draglakanet vid höften och axlarna. För att få ett mer ergonomiskt grepp bör hjälparen ta tag i så mycket tyg som möjligt.

Arbeta alltid med raka handleder och viktöverföring. Två hjälpare kan vända brukaren med SatinSheet tillsammans. Hjälparna samarbetar under arbetet. En hjälpare drar i SatinSheet medan den andra trycker försiktigt nedåt i madrassen i höjd med brukarens höfter och axlar.

När du använder SatinSheet 4Direction med handtag kan du vända brukaren tillsammans med en personlyft. Placera lakanets handtag i krokarna på lyftbygel och vänd långsamt brukaren (bild 4 + 5). Placera en positioneringskudde eller kil för att stödja ryggen och sänk långsamt lyften igen. Ta bort handtagen från lyftbygeln. Använd sänggrind vid behov.

Vänd brukaren.

Låsa glidsystemet efter vändning: Vik in överskjutande material från DrawSheet under madrassen på båda sidor av sängen.

Placera brukaren högre upp i sängen (bild 6)

Om brukaren ska flyttas högre upp i sängen tar hjälparen tag i SatinSheet 4Direction på båda sidor om brukarens axlar. Hjälparen står med ena foten framför den andra och drar med hjälp av viktöverföring.

Sitta upp i sängen med SatinSheet 4Direction (bild 7+8)

För att förhindra att brukaren glider ned i sängen när han/hon sitter upp, kan en del av SatinSheet 4Direction vikas in under

brukaren. Vik sedan in SatinSheet under madrassen, men endast vid höften. Därefter kan huvudänden höjas. Då fungerar SatinSheet som en broms.

Placering på magen

Ta bort sängens huvudända. Om användaren är ansluten till en ventilator eller andra livräddande maskiner, vänd användaren mot utrustningen. Placera användarens hand under höften. Lägg till 2-3 kuddar vid behov eller positioneringskuddar som används ovanpå användarens kropp. Placera en SatinSheet4Direction på kuddarna med satin vänt uppåt, med början i huvudänden – vik 4Direction bort från användarens huvud. Dra SatinSheet4Direction-toppen runt användaren som en kokong.

Vik den nedre 4Direction bort från användarens huvud (satin mot satin) En vårdare säkrar användarens huvud och en vårdare på varje sida för att stödja användaren. Flytta användaren till motsatt sida mot den plats dit användaren är vänd. Placera bandhandtagen från SatinSheet4Direction som användaren ligger på i lyftbygelns krokar och vrid långsamt användaren till nästan 90° (bild 9). Tryck och dra i SatinSheet4direction för att säkerställa att rotationen är lite utanför mitten. När användaren ligger på sidan drar en vårdare SatinSheet4Direction på sängen under användaren för att kunna ta bort den när användaren är vänd på mage. Samma vårdare stödjer användaren genom att ha händerna på axeln. Fortsätt att vända användaren tills användaren befinner sig i magläge. Sänk lyften igen. Ta bort handtagen från lyftbygelns krokar och ta bort SatinSheet4Direction. Vik ut 4Direction under användarens huvud. Om det är nödvändigt, flytta användaren till mitten av sängen. Se till att användaren är korrekt placerad. (bild 10). Höj sängräckena om det behövs. Vänd till ryggläge på samma sätt.

Information

Särskilda egenskaper

Kontrollera alltid produkten före användning och efter tvätt.

Använd aldrig en defekt produkt. Om produkten är sliten måste den kasseras.

Läs dessa instruktioner noga.

Det är viktigt att hjälparna får instruktioner i manuell förflyttningsteknik. Etac erbjuder råd och utbildning för hjälpare. Kontakta Etac om du vill veta mer.

Använd alltid rätt förflyttningsteknik.

Uppmuntra brukaren att hjälpa till så mycket som möjligt.

Planera alltid förflyttningen i förväg så att brukaren känner sig trygg och förflyttningen går smidigt.



Det finns risk att brukaren kan glida av. Lämna aldrig brukaren ensam på sängkanten.



Lämna aldrig produkten på golvet.



Genomför alltid en riskbedömning, kontrollera att hjälpmedlet går att använda hos den enskilde brukaren och se till att det är säkert för brukaren och hjälparna att använda det tillsammans med andra hjälpmedel.



Vi rekommenderar att sängens grindar sitter på plats när brukaren lämnas på glidsystemet, såvida man inte har konstaterat i en riskbedömning att det är säkert att lämna brukaren på glidsystemet utan att grindar sitter på plats.



Lås alltid glidsystemet när förflyttningen är färdig.

Kontakta Etac om du har några frågor.

Material och rengöring

Material:

SatinSheet 4Direction:

Poly/bomull: 55 % bomull/45 % polyester

Satin: Polyester.

SatinSheet In2Sheet 4Direction:

Ovansida i mikrofiber: Polyester

Mellanlager: 65 % polyester/35 % viskos

Barriär: Polyuretan

Glidområde: Polyester

Handtag: Nylon

Vingar: 55 % bomull/45 % polyester.

Absorbering: 2 200 ml/m².

Produkten bör kontrolleras regelbundet, helst varje gång den ska användas och särskilt efter tvätt.

Kontrollera att sömmar och tyg inte är skadade.



**Försök aldrig att reparera en produkt själv.
Använd aldrig en defekt produkt.**



**Det rekommenderas att produkten tvättas
före användning.**

Tvättinstruktioner:

Strykning förbättrar glideffekten.

Använd inte sköljmedel.

Produkten kan rengöras med rengöringsmedel utan lösningsmedel och med pH-värde 5–9 eller med 70 % tvättsprit.



Produkter och tillbehör

ArtikeInr	Produktbeskrivning	Storlek (mm)
IM4115S	SatinSheet 4Direction - midi (satin W1470xL1400 mm)	W2000xL1400
IM4115SH	SatinSheet 4Direction w/handles - midi (satin W1470xL1400)	W2000xL1400
IM4121S	SatinSheet 4Direction - maxi (satin W1470xL2000 mm)	W2000xL2000
IM4121SH	SatinSheet 4Direction w/handles - maxi (satin W1470xL2000)	W2000xL2000
IM4131SH	SatinSheet 4Direction w/handles maxi - wide	W3000xL2000
IM4110S	In2Sheet 4Direction w/wings - mini	W850xL900
IM4110SH	In2Sweet 4Direction w/wings + handles - mini	W850xL900
IM4140S	In2Sheet 4Direction w/wings - midi	W1200xL1400
IM4140SH	In2Sheet 4Direction w/wings and handles - midi	W1200xL1400

Set

Artikel nr.	Beskrivning	SatinSheet 2Direction BaseSheet	SatinSheet DrawSheet and SatinSheet 4Direction
IM4200S	SatinSheet DrawSheet midi set	IM4113S SatinSheet 2Direction midi	IM4118S SatinSheet DrawSheet - midi
IM4201S	SatinSheet DrawSheet mini set	IM4108S SatinSheet 2Direction mini	IM4116S SatinSheet DrawSheet - mini
IM4202S	SatinSheet DrawSheet maxi midi set	IM4114S SatinSheet 2Direction maxi	IM4118S SatinSheet DrawSheet - midi
IM4203S	SatinSheet 4Direction Fit midi set	IM4112S SatinSheet 2Direction FIT	IM4115S SatinSheet 4Direction - midi
IM4204S	SatinSheet 4Direction midi set	IM4113S SatinSheet 2Direction midi	IM4115S SatinSheet 4Direction - midi
IM4205S	SatinSheet DrawSheet midi small set	IM4119S SatinSheet 2Direction midi small	IM4118S SatinSheet DrawSheet - midi
IM4207S	SatinSheet 4Direction midi small set	IM4119S SatinSheet 2Direction midi small	IM4115S SatinSheet 4Direction - midi
IM4208S	SatinSheet Corner DrawSheet midi set	IM4107S SatinSheet 2Direction w/elastic	IM4118S SatinSheet DrawSheet - midi
IM4209S	SatinSheet In2Sheet midi mini set	IM4119S SatinSheet 2Direction midi small	IM4110S In2Sheet 4Direction w/wings - mini
IM4210S	SatinSheet In2Sheet mini set	IM4108S SatinSheet 2Direction mini	IM4110S In2Sheet 4Direction w/wings - mini
IM4211S	SatinSheet Corner 4Direction midi set	IM4107S SatinSheet 2Direction w/elastic	IM4115S SatinSheet 4Direction - midi
IM4212S	SatinSheet Corner 4Direction maxi set	IM4107S SatinSheet 2Direction w/elastic	IM4121S SatinSheet 4Direction - maxi
IM4213S	SatinSheet 4Direction maxi set	IM4114S SatinSheet 2Direction maxi	IM4121S SatinSheet 4Direction - maxi
IM4214S	SatinSheet 4Direction maxi set - wide	IM4177S SatinSheet2direction maxi - wide	IM4121S SatinSheet 4Direction - maxi
IM4215S	SatinSheet 4Direction maxi set - double	IM4180S SatinSheet 2Direction maxi - double	IM4121S SatinSheet 4Direction - maxi
IM4216S	SatinSheet 4Direction midi set - wide	IM4176S SatinSheet2direction midi - wide	IM4115S SatinSheet 4Direction - midi
IM4217S	SatinSheet 4Direction midi set - double	IM4179S SatinSheet2direction midi - double	IM4115S SatinSheet 4Direction - midi
IM4218S	SatinSheet 4Direction maxi midi set	IM4114S SatinSheet 2Direction maxi	IM4115S SatinSheet 4Direction - midi
IM4219S	SatinSheet 4Direction maxi midi set - wide	IM4177S SatinSheet2direction maxi - wide	IM4115S SatinSheet 4Direction - midi
IM4220S	SatinSheet 4Direction maxi midi set -double	IM4180S SatinSheet 2Direction maxi - double	IM4115S SatinSheet 4Direction - midi
IM4221S	SatinSheet DrawSheet maxi midi set - wide	IM4177S SatinSheet2direction maxi - wide	IM4118S SatinSheet DrawSheet - midi
IM4222S	SatinSheet DrawSheet maxi midi set - double	IM4180S SatinSheet 2Direction maxi - double	IM4118S SatinSheet DrawSheet - midi
IM4223S	SatinSheet DrawSheet midi set - wide	IM4176S SatinSheet2direction midi - wide	IM4118S SatinSheet DrawSheet - midi
IM4224S	SatinSheet DrawSheet midi set - double	IM4179S SatinSheet2direction midi - double	IM4118S SatinSheet DrawSheet - midi
IM4225S	SatinSheet Corner 4Direction midi set - wide	IM4147S SatinSheet 2Direction w/elastic-wide	IM4115S SatinSheet 4Direction - midi
IM4226S	SatinSheet Corner 4Direction midi set - double	IM4137S SatinSheet 2Direction w/elastic-double	IM4115S SatinSheet 4Direction - midi
IM4227S	SatinSheet Corner DrawSheet midi set - wide	IM4147S SatinSheet 2Direction w/elastic - wide	IM4118S SatinSheet DrawSheet - midi
IM4228S	SatinSheet Corner DrawSheet midi set - double	IM4137S SatinSheet 2Direction w/elastic-double	IM4118S SatinSheet DrawSheet - midi
IM4229S	SatinSheet Corner 4Direction maxi set - wide	IM4147S SatinSheet 2Direction w/elastic - wide	IM4121S SatinSheet 4Direction - maxi
IM4230S	SatinSheet Corner 4Direction maxi set - double	IM4137S SatinSheet 2Direction w/elastic - double	IM4121S SatinSheet 4Direction - maxi
IM4231S	SatinSheet Corner 4Direction w/handle midi set	IM4107S SatinSheet 2Direction w/elastic	IM4115SH SatinSheet 4Direction w/handles- midi
IM4251S	SatinSheet 4Direction maxi midi set - small		

Kombinationer

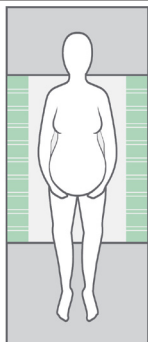

Article no.	BaseSheet - Mini
IM4133S	SatinSheet 2Direction mini - small
IM4108S	SatinSheet 2Direction mini
IM4175S	SatinSheet 2Direction mini - wide
IM4178S	SatinSheet 2Direction mini - double
BaseSheet - Mini kan kombineras med:	
Article no.	DrawSheet, 4Direction and PillowCase
IM4116S	SatinSheet drawSheet - mini
IM4110S	In2Sheet 4Direction w/wings - mini
IM4110SH	In2Sheet 4Direction w/wings + handles - mini
IM4117S	SatinSheet 2Direction PillowCase

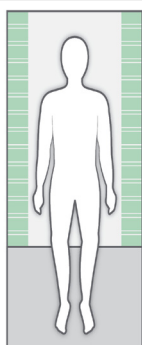

Article no.	BaseSheet - Midi
IM4119S	SatinSheet 2Direction midi small
IM4113S	SatinSheet 2Direction midi
IM4176S	SatinSheet 2Direction midi - wide
IM4179S	SatinSheet 2Direction midi - double
BaseSheet - Midi kan kombineras med:	
Article no.	DrawSheet, 4Direction and PillowCase
IM4118S	SatinSheet DrawSheet - midi
IM4115S	SatinSheet 4Direction - midi
IM4115SH	SatinSheet 4Direction w/handles - midi
IM4121S	SatinSheet 4Direction - maxi
IM4121SH	SatinSheet 4Direction w/handles - maxi
IM4117S	SatinSheet 2Direction PillowCase

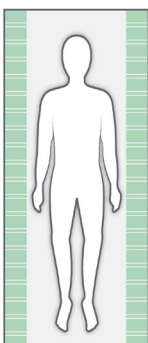

Article no.	BaseSheet - Maxi
IM4181S	SatinSheet 2Direction maxi - small
IM4114S	SatinSheet 2Direction maxi
IM4177SH	SatinSheet 2Direction maxi - wide
IM4180S	SatinSheet 2Direction maxi - double
IM4122S	SatinSheet 2Direction 180cm bed
Article no.	BaseSheet - Maxi Corner
IM4107S	SatinSheet 2Direction Corner
IM4147S	SatinSheet 2Direction Corner - wide
IM4137S	SatinSheet 2Direction Corner - double
Article no.	BaseSheet - Maxi Fit
IM4112S	SatinSheet 2Direction Fit
IM4142S	SatinSheet 2Direction Elastic Fit
Article no.	BaseSheet - Mini, Midi and Maxi Corner
IM4167S	SatinSheet 2Direction Corner - small -mini
IM4157S	SatinSheet 2Direction Corner - midi
IM4197S	SatinSheet 2Direction Corner - double - double - maxi
BaseSheet - Maxi/Corner/Fit kan kombineras med:	
Article no.	4Direction and In2Sheet 4Direction
M4115S	SatinSheet 4Direction - midi
IM4115SH	SatinSheet 4Direction w/handles - midi
IM4140S	In2Sheet 4Direction w/wings - midi
IM4140SH	In2Sheet 4Direction - w/wings + handles - midi
IM4121S	SatinSheet 4Direction - maxi
IM4121SH	SatinSheet 4Direction w/handles - maxi

Kom ihåg SatinSheet PillowCase (2D)

IM4117S	SatinSheet 2Direction PillowCase
---------	----------------------------------

Inspektion

Första inspektion:

- Är förpackningen oskadad?
- Läs etiketten på förpackningen och kontrollera artikelnummer och produktbeskrivning.
- Kontrollera att Kortinformationen har bifogats en aktuell bruksanvisning kan laddas ned från www.etac.se eller beställas via Etacs kundtjänst eller din lokala återförsäljare
- Kontrollera etiketten på produkten – innehåller den artikelnummer, produktbeskrivning, parti-/batchnummer, rengöringsinstruktioner och leverantörens namn?

Regelbundna inspektioner:

- Kontrollera att det manuella överflyttningssystemet alltid är i perfekt skick.
- Kontrollera alltid material, sömmar, handtag och spännen efter rengöring.
- Om produkten visar spår av förslitning måste den omedelbart tas ur bruk.



Visuell inspektion/kontrollera produkten:

Kontrollera att material, sömmar, stygn, handtag och spännen är hela/utan fel.



Stabilitetstest:

Försök att böja produkten för att kontrollera att den känns fast och stabil.

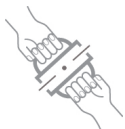

Mekanisk belastning/test av handtag:

Dra hårt i handtagen åt motsatt håll och kontrollera material, sömmar och stygn.

Test av spännen:

Stäng spännet och dra åt motsatt håll. Kontrollera spännet och stygnen.



Testa låg/hög friktion:

Placera produkten på en fast yta eller säng, lägg händerna på materialet och testa friktionen genom att trycka händerna ned mot produkten.

Låg friktion – glider enkelt

Hög friktion – glider/rör sig inte

Kontrollera:

Hjälpmiddel för manuell förflyttning med handtag, remmar och spännen:



Hjälpmiddel för manuell förflyttning, sittande och liggande med hög eller låg friktion:



Produktionsår, månad og dag



Produkten kan avfallshandteras i enlighet med nationella bestämmelser



Läs bruksanvisningen

Generelt

Takk for at du har valgt et produkt fra Etac.

Les bruksanvisningen grundig for å unngå uhell og skader under flytting og bruk av produktene.

Personen som betegnes som "brukeren" i denne bruksanvisningen er personen som ligger i, eller sitter på, produktet. Assistenten eller assistentene er personene som manøvrerer produktet.



Dette symbolet vises ved siden av teksten i bruksanvisningen. Den trekker leserens oppmerksomhet mot punkter hvor det kan være fare for brukerens eller assistentens helse eller sikkerhet.

Produktene overholder standardene for Klasse 1-produkter i forskrift om medisinsk utstyr (EU) 2017/745 Medisinsk utstyr.

Hos Etac arbeider vi kontinuerlig med å forbedre produktene våre. Vi forbeholder oss derfor retten til å endre produktene uten ytterligere forvarsel. Alle mål i illustrasjoner og liknende materiell er kun veiledende. Etac er ikke ansvarlig for feil og defekter.

Innholdet i denne bruksanvisningen, inkludert anbefalinger,

kombinasjoner og størrelser, gjelder ikke ved spesialbestillinger eller modifikasjoner. Hvis kunden foretar justeringer, reparasjoner eller kombinasjoner som ikke er avtalt med Etac på forhånd, vil Etacs CE-sertifisering og garanti være ugyldig. Kontakt Etac hvis du er i tvil.

Garanti: To års garanti mot material- og produksjonsfeil forutsatt at produktet brukes på riktig måte.

Forventet levetid: Utstyret har en forventet levetid på 1 til 2 år under normal bruk. Utstyrets levetid varierer avhengig av brukshyppighet, belastning og hvor ofte og hvordan det blir vasket.

Se www.etac.no for mer informasjon om Etacs forflytningshjelpemidler.

Hvis det skulle oppstå en uønsket hendelse relatert til utstyret, skal hendelsen rapporteres til din lokale forhandler og nasjonale myndigheter innen rimelig tid. Den lokale forhandleren vil videregående informasjon til produsenten.

Generelle symboler



Vasking



pH-nivå / Tørkes av med klut



Advarsel



Produsent



Må ikke blekes



Etterlat ikke produktet på gulvet



Produksjonsår, måned og dag



CE-merking



Tørkes i tørketrommel



Fare for nedglidning



Batchnummer / LOT-nummer.



Må holdes tørr



Strykes



Må ikke utsettes for sollys



Maks brukervekt = maksimalt testet belastning



Ikke steril



Må ikke renses



Les bruksanvisningen



Produktet kan kasseres i henhold til gjeldende regelverk.



Artikkelnummer



Medisinsk utstyr

Bruksområde

SatinSheet 4Direction er et DrawSheet for bruk sammen med et BaseSheet (SatinSheet BaseSheet 2Direction). SatinSheet-systemet brukes til å reposisjonere og vende en bruker i sengen.

Bruksmiljø

Akuttmottak, sykehus, hjemmesykepleie

Praktisk bruk

Plassering

Plasser SatinSheet BaseSheet midt i sengen med lavfriksjonsmaterialet (sateng) vendt opp (illustrasjoner). Ved behov kan et stikklaken legges over SatinSheet.

Alle SatinSheet-modeller har en etikett med "denne siden opp" som gjør det enklere å kontrollere at riktig side vendes opp i sengen.

Det er sydd fast en informasjonsetikett med beskrivelse av korrekt bruk av produktet i alle SatinSheet-modeller/-produkter.

Plasser SatinSheet 4Direction oppe på BaseSheet (sateng mot sateng).

Før glidesystemet låses under madrassen, må alle ujevnheter og folder gattes ut for å forebygge trykksår. Assistentene trekker samtidig og diagonalt fra begge sider.

Bruk

Vending med SatinSheet 4Direction (illustrasjon 1-3)

SatinSheet 4Direction må alltid brukes sammen med en av SatinSheet-modellene.

Baksiden av SatinSheet 4Direction er produsert av et materiale med lav friksjon. Produktet er godt egnet til bariatriske brukere. Prosedyren for vending med SatinSheet 4Direction er den samme som prosedyren for vending med SatinSheet eller et stikklaken.

Vende en bruker i sengen: Ta tak i stikklakenet ved hofter og skuldre. Assistenten bør ta tak i så mye stoff som mulig for et mer ergonomisk riktig grep.

Assistenten må alltid ha flate håndledd og bruke vektoverføring. Vending med SatinSheet kan også utføres av to assistenter. Assistentene samarbeider. En assistent hjelper til med å trekke opp SatinSheet mens den andre assistenten trekker ned i høyde med brukerens hofter og skuldre samtidig som han eller hun skyver forsiktig.

Om du benytter SatinSheet 4Direction med håndtak, kan du også feste håndtakene til en personløfter og la den foreta vendingen. Fest håndtakene i løftebøylen, for så å vende brukeren trygt og enkelt over på siden. (se illustrasjon 4+5). Det anbefales og plassere en posisjonering pute eller kile bak ryggen på brukeren etter vendingen for å stabilisere og skape trygghet. Deretter senke løfte armen ned igjen, og fjern håndtakene fra løftebøylen. Husk og sikre brukeren med å sette opp sidegrindene.

Vend brukeren.

Låse glidesystemet etter vending: Brett overskuddsmaterialet fra DrawSheet inn under madrassen på begge sider av sengen.

Forflytte brukeren høyere opp i sengen (illustrasjon 6)

For å forflytte brukeren høyere opp i sengen tar assistenten tak i SatinSheet 4Direction på begge sider av brukerens skuldre. Assistenten står med den ene foten foran den andre og trekker slik at han eller hun bruker vektoverføring.

Sitte i sengen med SatinSheet 4Direction (illustrasjon 7+8)

For å forhindre at brukeren glir ned i sengen når han eller hun

sitter, kan deler av SatinSheet 4Direction brettes inn under brukeren. Brett deretter SatinSheet inn under madrassen, men kun ved hofte høyde. Hodeenden kan heves. Her fungerer SatinSheet som en bremse.

Mageleie

Fjern sengens hodeende. Hvis brukeren er koblet til en respirator eller andre livreddende maskiner, vender du brukeren mot utstyret. Plasser hånden til brukeren under hoften. Om nødvendig legg 2–3 hodeputer eller posisjoneringsputer oppå kroppen til brukeren. Plasser et SatinSheet4Direction oppå putene med satengsiden vendt oppover og begynn ved hodeenden. Brett 4Direction-lakenet vekk fra brukerens hode. Pakk det øverste SatinSheet4Direction-lakenet rundt brukeren som en kokong.

Brett det nederste 4Direction-lakenet vekk fra brukerens hode (sateng mot sateng). En av assistentene sikrer brukerens hode og en assistent på hver side støtter brukeren. Flytt brukeren til motsatt side av den siden brukeren skal vendes mot. Plasser strophåndtakene på SatinSheet4Direction som brukeren ligger på i løftebøylefestene og vend brukeren sakte til nesten 90° (illustrasjon 9). Dytt og dra i SatinSheet4Direction for å sikre at rotasjonen gjøres litt bortenfor midten av sengen. Når brukeren ligger på siden, skal en av assistentene dytte SatinSheet4Direction på sengen innunder brukeren slik at det kan fjernes når brukeren er lagt i mageleie. Den samme assistenten støtter brukeren ved å legge hendene på brukerens skuldre. Fortsett å inntil brukeren ligger i mageleie. Senk løfteren igjen. Fjern håndtakene fra løftebøylefestene og fjern SatinSheet4Direction. Brett 4Direction ut igjen under brukerens hode. Om nødvendig flytt brukeren til midten av sengen. Sørg for at brukeren er riktig posisjonert (illustrasjon 10). Hev sengehesten om nødvendig. Vend brukeren over i ryggleie på samme måte.

Merknad

Spesialfunksjoner

Produktet må alltid kontrolleres før bruk og etter rengjøring.

Hvis produktet er defekt, må det ikke brukes. Hvis produktet virker slitt, må det kastes.

Les bruksanvisningen grundig.

Det er viktig at assistenter får opplæring i manuell forflytning. Etac tilbyr rådgivning og opplæring av assistenter. Kontakt Etac for ytterligere informasjon.

Korrekte teknikker for manuell forflytning må alltid brukes.

Brukeren kan oppfordres til å bidra når det er mulig.

Den manuelle forflytningen må alltid planlegges på forhånd for å sikre at brukeren er trygg og at all manuell forflytning foregår så smidig som mulig.



Brukeren kan gli av utstyret. Brukeren må aldri forlates på sengekanten.



Produktet må aldri forlates på gulvet.



Det må alltid foretas en risikovurdering, og det må kontrolleres at hjelpemiddelet kan brukes sammen med den individuelle brukeren og i kombinasjon med annet utstyr slik at både brukeren og assistenten er trygg.



Det anbefales å bruke gavler når brukeren ligger på glidesystemet over tid, med mindre en risikovurdering har avdekket at brukeren kan ligge på glidesystemet uten gavler.



Glidesystemet må alltid låses når forflytningen er fullført.

Kontakt Etac hvis du er i tvil.

Materiale og rengjøring

Materiale:

SatinSheet 4Direction:

Polybomull: 55% bomull/45% polyester

Sateng: Polyester.

SatinSheet In2Sheet 4Direction:

Mikrofiber overside: Polyester

Mellomlag: 65 % polyester/35 % viskose

Barriere: Polyuretan

Glideområde: Polyester

Håndtak: Nylon

Vinger: 55 % bomull/45% polyester.

Absorpsjon: 2200 ml/m².

Produktet skal kontrolleres regelmessig, fortrinnsvis ved hver bruk, og ekstra nøye etter vask.

Kontroller at sømmer og stoff ikke er skadet.



Du må aldri forsøke å reparere produktet selv. Hvis produktet er defekt, må det ikke brukes.



Anbefalt å vaske produktet før bruk.

Vaskeinstruks:

Stryking gir bedre glideeffekt.

Ikke bruk tøymykner.

Produktet kan vaskes med et løsemiddelfritt rengjøringsmiddel med pH mellom 5 og 9, eller desinfiseres med 70 % konsentrasjon.



Produkter og tilbehør

Artikkelnr.	Beskrivelse	Størrelse (mm)
IM4115S	SatinSheet 4Direction - midi (satin W1470xL1400 mm)	W2000xL1400
IM4115SH	SatinSheet 4Direction w/handles - midi (satin W1470xL1400)	W2000xL1400
IM4121S	SatinSheet 4Direction - maxi (satin W1470xL2000 mm)	W2000xL2000
IM4121SH	SatinSheet 4Direction w/handles - maxi (satin W1470xL2000)	W2000xL2000
IM4131SH	SatinSheet 4Direction w/handles maxi - wide	W3000xL2000
IM4110S	In2Sheet 4Direction w/wings - mini	W850xL900
IM4110SH	In2Sweet 4Direction w/wings + handles - mini	W850xL900
IM4140S	In2Sheet 4Direction w/wings - midi	W1200xL1400
IM4140SH	In2Sheet 4Direction w/wings and handles - midi	W1200xL1400

Sett

Artikkel nr.	Beskrivelse	SatinSheet 2Direction BaseSheet	SatinSheet DrawSheet and SatinSheet 4Direction
IM4200S	SatinSheet DrawSheet midi set	IM4113S SatinSheet 2Direction midi	IM4118S SatinSheet DrawSheet - midi
IM4201S	SatinSheet DrawSheet mini set	IM4108S SatinSheet 2Direction mini	IM4116S SatinSheet DrawSheet - mini
IM4202S	SatinSheet DrawSheet maxi midi set	IM4114S SatinSheet 2Direction maxi	IM4118S SatinSheet DrawSheet - midi
IM4203S	SatinSheet 4Direction Fit midi set	IM4112S SatinSheet 2Direction FIT	IM4115S SatinSheet 4Direction - midi
IM4204S	SatinSheet 4Direction midi set	IM4113S SatinSheet 2Direction midi	IM4115S SatinSheet 4Direction - midi
IM4205S	SatinSheet DrawSheet midi small set	IM4119S SatinSheet 2Direction midi small	IM4118S SatinSheet DrawSheet - midi
IM4207S	SatinSheet 4Direction midi small set	IM4119S SatinSheet 2Direction midi small	IM4115S SatinSheet 4Direction - midi
IM4208S	SatinSheet Corner DrawSheet midi set	IM4107S SatinSheet 2Direction w/elastic	IM4118S SatinSheet DrawSheet - midi
IM4209S	SatinSheet In2Sheet midi mini set	IM4119S SatinSheet 2Direction midi small	IM4110S In2Sheet 4Direction w/wings - mini
IM4210S	SatinSheet In2Sheet mini set	IM4108S SatinSheet 2Direction mini	IM4110S In2Sheet 4Direction w/wings - mini
IM4211S	SatinSheet Corner 4Direction midi set	IM4107S SatinSheet 2Direction w/elastic	IM4115S SatinSheet 4Direction - midi
IM4212S	SatinSheet Corner 4Direction maxi set	IM4107S SatinSheet 2Direction w/elastic	IM4121S SatinSheet 4Direction - maxi
IM4213S	SatinSheet 4Direction maxi set	IM4114S SatinSheet 2Direction maxi	IM4121S SatinSheet 4Direction - maxi
IM4214S	SatinSheet 4Direction maxi set - wide	IM4177S SatinSheet2direction maxi - wide	IM4121S SatinSheet 4Direction - maxi
IM4215S	SatinSheet 4Direction maxi set - double	IM4180S SatinSheet 2Direction maxi - double	IM4121S SatinSheet 4Direction - maxi
IM4216S	SatinSheet 4Direction midi set - wide	IM4176S SatinSheet2direction midi - wide	IM4115S SatinSheet 4Direction - midi
IM4217S	SatinSheet 4Direction midi set - double	IM4179S SatinSheet2direction midi - double	IM4115S SatinSheet 4Direction - midi
IM4218S	SatinSheet 4Direction maxi midi set	IM4114S SatinSheet 2Direction maxi	IM4115S SatinSheet 4Direction - midi
IM4219S	SatinSheet 4Direction maxi midi set - wide	IM4177S SatinSheet2direction maxi - wide	IM4115S SatinSheet 4Direction - midi
IM4220S	SatinSheet 4Direction maxi midi set - double	IM4180S SatinSheet 2Direction maxi - double	IM4115S SatinSheet 4Direction - midi
IM4221S	SatinSheet DrawSheet maxi midi set - wide	IM4177S SatinSheet2direction maxi - wide	IM4118S SatinSheet DrawSheet - midi
IM4222S	SatinSheet DrawSheet maxi midi set - double	IM4180S SatinSheet 2Direction maxi - double	IM4118S SatinSheet DrawSheet - midi
IM4223S	SatinSheet DrawSheet midi set - wide	IM4176S SatinSheet2direction midi - wide	IM4118S SatinSheet DrawSheet - midi
IM4224S	SatinSheet DrawSheet midi set - double	IM4179S SatinSheet2direction midi - double	IM4118S SatinSheet DrawSheet - midi
IM4225S	SatinSheet Corner 4Direction midi set - wide	IM4147S SatinSheet 2Direction w/elastic-wide	IM4115S SatinSheet 4Direction - midi
IM4226S	SatinSheet Corner 4Direction midi set - double	IM4137S SatinSheet 2Direction w/elastic-double	IM4115S SatinSheet 4Direction - midi
IM4227S	SatinSheet Corner DrawSheet midi set - wide	IM4147S SatinSheet 2Direction w/elastic - wide	IM4118S SatinSheet DrawSheet - midi
IM4228S	SatinSheet Corner DrawSheet midi set - double	IM4137S SatinSheet 2Direction w/elastic-double	IM4118S SatinSheet DrawSheet - midi
IM4229S	SatinSheet Corner 4Direction maxi set - wide	IM4147S SatinSheet 2Direction w/elastic - wide	IM4121S SatinSheet 4Direction - maxi
IM4230S	SatinSheet Corner 4Direction maxi set - double	IM4137S SatinSheet 2Direction w/elastic - double	IM4121S SatinSheet 4Direction - maxi
IM4231S	SatinSheet Corner 4Direction w/handle midi set	IM4107S SatinSheet 2Direction w/elastic	IM4115SH SatinSheet 4Direction w/handles- midi
IM4251S	SatinSheet 4Direction maxi midi set - small		

Kombinasjoner

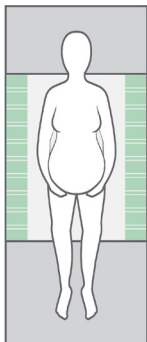

Article no.	BaseSheet - Mini
IM4133S	SatinSheet 2Direction mini - small
IM4108S	SatinSheet 2Direction mini
IM4175S	SatinSheet 2Direction mini - wide
IM4178S	SatinSheet 2Direction mini - double
BaseSheet - Mini kan kombineres med:	
Article no.	DrawSheet, 4Direction and PillowCase
IM4116S	SatinSheet drawSheet - mini
IM4110S	In2Sheet 4Direction w/wings - mini
IM4110SH	In2Sheet 4Direction w/wings + handles - mini
IM4117S	SatinSheet 2Direction PillowCase

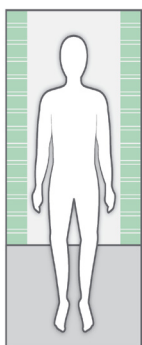

Article no.	BaseSheet - Midi
IM4119S	SatinSheet 2Direction midi small
IM4113S	SatinSheet 2Direction midi
IM4176S	SatinSheet 2Direction midi - wide
IM4179S	SatinSheet 2Direction midi - double
BaseSheet - Midi kan kombineres med:	
Article no.	DrawSheet, 4Direction and PillowCase
IM4118S	SatinSheet DrawSheet - midi
IM4115S	SatinSheet 4Direction - midi
IM4115SH	SatinSheet 4Direction w/handles - midi
IM4121S	SatinSheet 4Direction - maxi
IM4121SH	SatinSheet 4Direction w/handles - maxi
IM4117S	SatinSheet 2Direction PillowCase

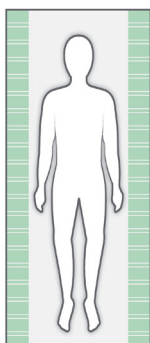

Article no.	BaseSheet - Maxi
IM4181S	SatinSheet 2Direction maxi - small
IM4114S	SatinSheet 2Direction maxi
IM4177SH	SatinSheet 2Direction maxi - wide
IM4180S	SatinSheet 2Direction maxi - double
IM4122S	SatinSheet 2Direction 180cm bed
Article no.	BaseSheet - Maxi Corner
IM4107S	SatinSheet 2Direction Corner
IM4147S	SatinSheet 2Direction Corner - wide
IM4137S	SatinSheet 2Direction Corner - double
Article no.	BaseSheet - Maxi Fit
IM4112S	SatinSheet 2Direction Fit
IM4142S	SatinSheet 2Direction Elastic Fit
Article no.	BaseSheet - Mini, Midi and Maxi Corner
IM4167S	SatinSheet 2Direction Corner - small -mini
IM4157S	SatinSheet 2Direction Corner - midi
IM4197S	SatinSheet 2Direction Corner - double - double - maxi
BaseSheet - Maxi/Corner/Fit kan kombineres med:	
Article no.	4Direction and In2Sheet 4Direction
M4115S	SatinSheet 4Direction - midi
IM4115SH	SatinSheet 4Direction w/handles - midi
IM4140S	In2Sheet 4Direction w/wings - midi
IM4140SH	In2Sheet 4Direction - w/wings + handles - midi
IM4121S	SatinSheet 4Direction - maxi
IM4121SH	SatinSheet 4Direction w/handles - maxi

Husk SatinSheet PillowCase (2D)

IM4117S	SatinSheet 2Direction PillowCase
---------	----------------------------------

Inspeksjon

Første gangs inspeksjon:

- Er emballasjen hel?
- Les etiketten på emballasjen, og kontroller artikkelnummer og produktbeskrivelse.
- Kontroller at den kort brukerveiledning er vedlagt. Oppdatert bruksanvisning kan lastes ned fra www.etac.no. Du kan også kontakte Etacs kundeservice eller din forhandler.
- Kontroller etiketten på produktet. Inneholder den artikkelnummer, produktbeskrivelse, LOT-/batchnummer, vaskeanvisning og leverandørens navn?

Periodisk inspeksjon:

- Kontroller at det manuelle forflytningshjelpemiddelet alltid er i god stand.
- Materialer, sømmer, håndtak og spenner må alltid kontrolleres etter rengjøring.
- Hvis produktet har tegn på slitasje, må det umiddelbart tas ut av bruk.



Visuell inspeksjon / kontroller produktet:

Kontroller at materialene, sømmene, håndtakene og stroppene er hele og uten feil.



Stabilitetstest:

Forsøk å bøye produktet. Kontroller at det føles fast, stabilt og solid.



Mekanisk belastning eller stress /

Test av håndtak:

Trekk hardt i håndtakene i flere retninger, og kontroller materialet og sømmene.

Test av spenner:

Fest spennene, og trekk i flere retninger. Kontroller spennen og sømmene.



Test lav/høy friksjon:

Plasser produktet på fast underlag eller en seng, legg hendene på materialet og test friksjonen ved å presse hendene dine ned i produktet.

Lav friksjon – glir uten motstand

Høy friksjon – ingen glidning/bevegelse

Kontroller:

Manuelle forflytningshjelpemidler med håndtak, stropper og spenner:



Manuelle forflytningshjelpemidler for sittende og liggende forflytning med høy eller lav friksjon:



Produksjonsår, måned og dag



Produktet kan kasseres i henhold til gjeldende regelverk.



Les bruksanvisningen

Generelt

Tak, fordi du valgte et produkt fra Etac.

For at undgå ulykker og skader i forbindelse med håndtering og brug af produkterne, skal denne manual læses grundigt igennem.

Brugeren i denne manual er den person, der ligger eller sidder på produktet. Hjælperen er den person, der manøvrerer produktet.



Dette symbol forekommer i manualen sammen med teksten for at gøre opmærksom på tidspunkter, hvor der er risiko for brugerens eller hjælpernes sikkerhed.

Produktene overholder standardene for Klasse 1-produkter i Forordningen om medicinsk udstyr (EU) 2017/745 medicinsk udstyr

Hos Etac bestræber vi os på kontinuerligt at forbedre vores produkter. Vi forbeholder os derfor ret til at ændre produkterne uden forudgående meddelelse. Alle mål, der angives på illustrationer eller andet materiale, er kun vejledende, og der tages forbehold for fejl og mangler.

Informationen i denne manual, inkl. anbefalinger, kombinationer og størrelser, gælder ikke for specialtilpasninger og modifikationer. Hvis kunden foretager ændringer, reparationer eller kombinationer, der ikke er godkendt af Etac, bortfalder Etacs CE-mærkning, og Etacs garanti ophører. Ved tvivl kontakt venligst Etac.

Garanti: To år på materiale- og produktionsfejl ved korrekt anvendelse af produktet.

Forventet levetid: Produktet har en forventet levetid på 1-2 år ved normal brug. Levetiden for produktet varierer afhængigt af brugshyppighed, belastninger samt hvor ofte og hvordan det er blevet vasket.

For yderligere information om Etacs sortiment indenfor forflytning se www.etac.com.

Hvis der opstår en utilsigtet hændelse i forbindelse med produktet, skal hændelsen indberettes til den lokale forhandler og den nationale kompetente myndighed uden unødigt forsinkelse. Den lokale forhandler vil videresende oplysningerne til producenten.

Symboler



Vask



pH-værdi / Aftørring



Advarsel



Producent



Ingen blegning



Efterlad aldrig på gulv



Produktionsår, -måned og -dag



CE-mærkning



Tørretumbling



Nedglidningsrisiko



Batch-/lotnummer



Opbevares tørt



Strygning



Beskyt mod sollys



Maks. brugervægt = maks. nominel belastning



Ikke-steril



Ingen rens



Læs manual



Produktet bortskaffes i henhold til nationale regler



Artikelnummer



Medicinsk udstyr

Tilsigtet formål

Træklagnet SatinSheet 4Direction er et DrawSheet, som anvendes sammen med et BaseSheet (SatinSheet BaseSheet 2Direction). SatinSheet-systemet anvendes til at lejre og vende en bruger i sengen.

Tilsigtet miljø

Hospitaler, institutioner og hjemme.

Praktisk håndtering

Placering

SatinSheet BaseSheet placeres med det friktionsnedsættende materiale (satin) opad centralt på sengen (Illustrationer). Skal der anvendes trækklagen, placeres dette ovenpå. Alle SatinSheet-modeller er forsynet med labelen "This side up", som angiver, hvilken side der skal vende opad i sengen. Alle SatinSheet-produkter/-modeller har også en kort information omkring håndtering af produktet fastsyet på lagnet.

Placer SatinSheet 4Direction på BaseSheet (satin mod satin).

Inden glidesystemet "låses" under madrassen, skal eventuelle ujævnheder/rynker udjævnes for at undgå tryksår. Dette gøres ved samtidigt at trække diagonalt fra hver side.

Anvendelse

Vending med SatinSheet 4Direction (Illustration 1-3)

SatinSheet 4Direction anvendes altid sammen med en af SatinSheet-modellerne.

SatinSheet 4Direction har et friktionsnedsættende materiale (satin) på undersiden og er specielt velegnet til bariatriske brugere. Proceduren for vending med SatinSheet 4Direction er den samme som for vending med SatinSheet og trækklagen. Vending foretages ved at gribe i trækklaget ved hofter og skulder. For at opnå et bedre ergonomisk greb, skal man tage fat i så meget materiale som muligt.

Arbejd altid med strakte håndled og vægtoverføring. Vending med SatinSheet kan også udføres med to hjælpere. De to hjælpere skal samarbejde. Den ene hjælper trækker i SatinSheet, og den anden trykker ned i madrassen omkring skulder og hofter og skubber langsomt.

Hvis du bruger SatinSheet 4Direction w/handles, kan du vende brugeren med en lift. Placer håndtagene i løfteåget, og vend brugeren langsomt om på siden (Illustration 4 + 5). Placer en positioneringspude eller kile i ryggen, og sænk langsomt løfteåget igen, fjern håndtagene fra åget. Hæv sengehesten efter behov.

Vend brugeren.
Efter vending låses glidesystemet ved at skubbe det overskydende materiale fra DrawSheet ind under madrassen på begge sider af sengen.

Højere op i seng (Illustration 6)

For at forflytte brugeren højere op i sengen tages der fat i SatinSheet 4Direction ved brugerens skulder i begge sider. Stå i skridtstående stilling, og benyt vægtoverføring til at trække.

Sid oprejst i seng med SatinSheet 4Direction (Illustration 7+8)

Nedadglidning i sengen ved siddestilling kan forebygges ved at

bukke en del af SatinSheet 4Direction ind under brugeren. Buk derefter SatinSheet ind under madrassen, dog kun ved hoften. Derefter kan hovedgærdet eleveres, og SatinSheet virker som en bremsefunktion.

Bugleje

Fjern sengens hovedgærde. Hvis brugeren er tilsluttet til en respirator eller andet livreddende udstyr, skal brugeren lejres, så vedkommende vender mod udstyret. Anbring brugerens hånd under hoften. Læg eventuelt yderligere 2-3 puder eller lejringspuder oven på brugerens krop. Læg et SatinSheet4Direction på puderne med satinsiden opad. Start i hovedenden, og fold 4Direction væk fra brugerens hoved. Stop toppen af SatinSheet4Direction ind under brugeren som et svøb.

Fold den nederste del af 4Direction væk fra brugerens hoved (satin mod satin) Én plejeperson skal holde brugerens hoved stabilt, og én plejeperson på hver side skal støtte brugeren. Flyt brugeren til den modsatte side af der, hvor brugeren skal vendes til. Anbring remmene fra SatinSheet4Direction, som brugeren lå på, i løftebommens kroge, og vend langsomt brugeren til næsten 90° (illustration 9). Skub og træk i SatinSheet4direction for at sikre, at rotationen er en smule forskudt i forhold til midten. Når brugeren ligger på siden, stopper den ene plejeperson SatinSheet4Direction på sengen ind under brugeren, så det kan fjernes, når brugeren vendes til bugleje. Den samme plejeperson støtter brugeren ved at have sine hænder på brugerens skulder. Fortsæt indtil brugeren er i bugleje. Sænk liften igen. Fjern håndtagene fra løftebommens kroge, og fjern SatinSheet4Direction. Fold 4Direction ud under brugerens hoved. Flyt om nødvendigt brugeren til midten af sengen. Kontroller, at brugeren er lejret korrekt (illustration 10). Hæv sengehestene, hvis det er nødvendigt. Anvend samme fremgangsmåde for at vende brugeren til rygleje.

Information

Vær opmærksom på

Kontrollér altid produktet før brug og efter vask.

Anvend aldrig et defekt produkt. Ved tegn på slitage skal produktet kasseres.

Læs instruktionen grundigt.

Det er vigtigt at hjælpere og plejepersonale modtager instruktion omkring håndtering af forflytninger. Etac tilbyder hjælp og uddannelse af plejepersonale. Kontakt Etac for yderligere information.

Anvend altid korrekt forflytningsteknik.

Husk at udnytte brugerens egne ressourcer.

Planlæg forflytningen på forhånd, så det sker så trygt og problemfrit som muligt.



Nedglidningsrisiko, efterlad aldrig brugeren alene på sengekanten.



Efterlad aldrig produktet på gulvet.



Foretag altid en risikovurdering, og sørg for at hjælpemidlet kan anvendes til den enkelte bruger, og at det i kombination med andet udstyr er sikkert for brugeren og hjælperne.



Det anbefales at bruge sengeheste, når brugeren ligger på glidesystemet, medmindre en risikovurdering har fastslået, at det er sikkert at efterlade brugeren på glidesystemet uden brug af sengeheste.



Husk at låse glidesystemet efter endt forflytning.

Ved tvivlsspørgsmål – kontakt venligst Etac.

Materiale og rengøring

Materiale:

SatinSheet 4Direction:

Polycotton: 55 % bomuld/45 % polyester.

Satin: Polyester.

SatinSheet In2Sheet 4Direction:

Microfiberoverside: Polyester

Mellemlag: 65% polyester/35% viskose

Barriere: Polyurethan

Glideområde: Polyester

Håndtag: Nylon

Vinger: 55 % bomuld/45 % polyester.

Absorptionsevne: 2200ml/m².

Produktet skal kontrolleres regelmæssigt, helst hver gang før brug. Vær specielt omhyggelig efter vask.

Kontrollér, at der ikke er skader ved sømme og stof.



**Reparér aldrig selv et produkt.
Et defekt produkt må ikke anvendes.**



**Det anbefales, at produktet vaskes før
ibrugtagning.**

Vaskeinstruktion:

Strygning forbedrer glideevnen.

Anvend ikke skyllemiddel.

Produktet kan rengøres med et opløsningsmiddelfrit rengøringsmiddel med et pH-niveau mellem 5-9 eller med 70% desinfektionsopløsning.



Produkter og tilbehør

Varenr.	Beskrivelse	Størrelse i mm
IM4115S	SatinSheet 4Direction - midi (satin W1470xL1400 mm)	W2000xL1400
IM4115SH	SatinSheet 4Direction w/handles - midi (satin W1470xL1400)	W2000xL1400
IM4121S	SatinSheet 4Direction - maxi (satin W1470xL2000 mm)	W2000xL2000
IM4121SH	SatinSheet 4Direction w/handles - maxi (satin W1470xL2000)	W2000xL2000
IM4131SH	SatinSheet 4Direction w/handles maxi - wide	W3000xL2000
IM4110S	In2Sheet 4Direction w/wings - mini	W850xL900
IM4110SH	In2Sweet 4Direction w/wings + handles - mini	W850xL900
IM4140S	In2Sheet 4Direction w/wings - midi	W1200xL1400
IM4140SH	In2Sheet 4Direction w/wings and handles - midi	W1200xL1400

Sæt

Varenr.	Beskrivelse	SatinSheet 2Direction BaseSheet	SatinSheet DrawSheet and SatinSheet 4Direction
IM4200S	SatinSheet DrawSheet midi set	IM4113S SatinSheet 2Direction midi	IM4118S SatinSheet DrawSheet - midi
IM4201S	SatinSheet DrawSheet mini set	IM4108S SatinSheet 2Direction mini	IM4116S SatinSheet DrawSheet - mini
IM4202S	SatinSheet DrawSheet maxi midi set	IM4114S SatinSheet 2Direction maxi	IM4118S SatinSheet DrawSheet - midi
IM4203S	SatinSheet 4Direction Fit midi set	IM4112S SatinSheet 2Direction FIT	IM4115S SatinSheet 4Direction - midi
IM4204S	SatinSheet 4Direction midi set	IM4113S SatinSheet 2Direction midi	IM4115S SatinSheet 4Direction - midi
IM4205S	SatinSheet DrawSheet midi small set	IM4119S SatinSheet 2Direction midi small	IM4118S SatinSheet DrawSheet - midi
IM4207S	SatinSheet 4Direction midi small set	IM4119S SatinSheet 2Direction midi small	IM4115S SatinSheet 4Direction - midi
IM4208S	SatinSheet Corner DrawSheet midi set	IM4107S SatinSheet 2Direction w/elastic	IM4118S SatinSheet DrawSheet - midi
IM4209S	SatinSheet In2Sheet midi mini set	IM4119S SatinSheet 2Direction midi small	IM4110S In2Sheet 4Direction w/wings - mini
IM4210S	SatinSheet In2Sheet mini set	IM4108S SatinSheet 2Direction mini	IM4110S In2Sheet 4Direction w/wings - mini
IM4211S	SatinSheet Corner 4Direction midi set	IM4107S SatinSheet 2Direction w/elastic	IM4115S SatinSheet 4Direction - midi
IM4212S	SatinSheet Corner 4Direction maxi set	IM4107S SatinSheet 2Direction w/elastic	IM4121S SatinSheet 4Direction - maxi
IM4213S	SatinSheet 4Direction maxi set	IM4114S SatinSheet 2Direction maxi	IM4121S SatinSheet 4Direction - maxi
IM4214S	SatinSheet 4Direction maxi set - wide	IM4177S SatinSheet2direction maxi - wide	IM4121S SatinSheet 4Direction - maxi
IM4215S	SatinSheet 4Direction maxi set - double	IM4180S SatinSheet 2Direction maxi - double	IM4121S SatinSheet 4Direction - maxi
IM4216S	SatinSheet 4Direction midi set - wide	IM4176S SatinSheet2direction midi - wide	IM4115S SatinSheet 4Direction - midi
IM4217S	SatinSheet 4Direction midi set - double	IM4179S SatinSheet2direction midi - double	IM4115S SatinSheet 4Direction - midi
IM4218S	SatinSheet 4Direction maxi midi set	IM4114S SatinSheet 2Direction maxi	IM4115S SatinSheet 4Direction - midi
IM4219S	SatinSheet 4Direction maxi midi set - wide	IM4177S SatinSheet2direction maxi - wide	IM4115S SatinSheet 4Direction - midi
IM4220S	SatinSheet 4Direction maxi midi set - double	IM4180S SatinSheet 2Direction maxi - double	IM4115S SatinSheet 4Direction - midi
IM4221S	SatinSheet DrawSheet maxi midi set - wide	IM4177S SatinSheet2direction maxi - wide	IM4118S SatinSheet DrawSheet - midi
IM4222S	SatinSheet DrawSheet maxi midi set - double	IM4180S SatinSheet 2Direction maxi - double	IM4118S SatinSheet DrawSheet - midi
IM4223S	SatinSheet DrawSheet midi set - wide	IM4176S SatinSheet2direction midi - wide	IM4118S SatinSheet DrawSheet - midi
IM4224S	SatinSheet DrawSheet midi set - double	IM4179S SatinSheet2direction midi - double	IM4118S SatinSheet DrawSheet - midi
IM4225S	SatinSheet Corner 4Direction midi set - wide	IM4147S SatinSheet 2Direction w/elastic-wide	IM4115S SatinSheet 4Direction - midi
IM4226S	SatinSheet Corner 4Direction midi set - double	IM4137S SatinSheet 2Direction w/elastic-double	IM4115S SatinSheet 4Direction - midi
IM4227S	SatinSheet Corner DrawSheet midi set - wide	IM4147S SatinSheet 2Direction w/elastic - wide	IM4118S SatinSheet DrawSheet - midi
IM4228S	SatinSheet Corner DrawSheet midi set - double	IM4137S SatinSheet 2Direction w/elastic-double	IM4118S SatinSheet DrawSheet - midi
IM4229S	SatinSheet Corner 4Direction maxi set - wide	IM4147S SatinSheet 2Direction w/elastic - wide	IM4121S SatinSheet 4Direction - maxi
IM4230S	SatinSheet Corner 4Direction maxi set - double	IM4137S SatinSheet 2Direction w/elastic - double	IM4121S SatinSheet 4Direction - maxi
IM4231S	SatinSheet Corner 4Direction w/handle midi set	IM4107S SatinSheet 2Direction w/elastic	IM4115SH SatinSheet 4Direction w/handles- midi
IM4251S	SatinSheet 4Direction maxi midi set - small		

Kombinationer

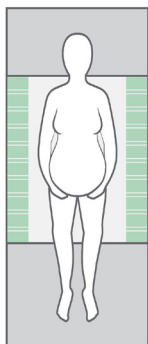

Article no.	BaseSheet - Mini
IM4133S	SatinSheet 2Direction mini - small
IM4108S	SatinSheet 2Direction mini
IM4175S	SatinSheet 2Direction mini - wide
IM4178S	SatinSheet 2Direction mini - double
BaseSheet - Mini kan kombineres med:	
Article no.	DrawSheet, 4Direction and PillowCase
IM4116S	SatinSheet drawSheet - mini
IM4110S	In2Sheet 4Direction w/wings - mini
IM4110SH	In2Sheet 4Direction w/wings + handles - mini
IM4117S	SatinSheet 2Direction PillowCase

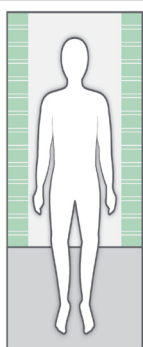

Article no.	BaseSheet - Midi
IM4119S	SatinSheet 2Direction midi small
IM4113S	SatinSheet 2Direction midi
IM4176S	SatinSheet 2Direction midi - wide
IM4179S	SatinSheet 2Direction midi - double
BaseSheet - Midi kan kombineres med:	
Article no.	DrawSheet, 4Direction and PillowCase
IM4118S	SatinSheet DrawSheet - midi
IM4115S	SatinSheet 4Direction - midi
IM4115SH	SatinSheet 4Direction w/handles - midi
IM4121S	SatinSheet 4Direction - maxi
IM4121SH	SatinSheet 4Direction w/handles - maxi
IM4117S	SatinSheet 2Direction PillowCase

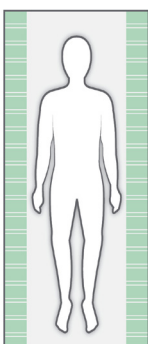

Article no.	BaseSheet - Maxi
IM4181S	SatinSheet 2Direction maxi - small
IM4114S	SatinSheet 2Direction maxi
IM4177SH	SatinSheet 2Direction maxi - wide
IM4180S	SatinSheet 2Direction maxi - double
IM4122S	SatinSheet 2Direction 180cm bed
Article no. BaseSheet - Maxi Corner	
IM4107S	SatinSheet 2Direction Corner
IM4147S	SatinSheet 2Direction Corner - wide
IM4137S	SatinSheet 2Direction Corner - double
Article no. BaseSheet - Maxi Fit	
IM4112S	SatinSheet 2Direction Fit
IM4142S	SatinSheet 2Direction Elastic Fit
Article no. BaseSheet - Mini, Midi and Maxi Corner	
IM4167S	SatinSheet 2Direction Corner - small -mini
IM4157S	SatinSheet 2Direction Corner - midi
IM4197S	SatinSheet 2Direction Corner - double - double - maxi
BaseSheet - Maxi/Corner/Fit kan kombineres med:	
Article no.	4Direction and In2Sheet 4Direction
M4115S	SatinSheet 4Direction - midi
IM4115SH	SatinSheet 4Direction w/handles - midi
IM4140S	In2Sheet 4Direction w/wings - midi
IM4140SH	In2Sheet 4Direction - w/wings + handles - midi
IM4121S	SatinSheet 4Direction - maxi
IM4121SH	SatinSheet 4Direction w/handles - maxi

Husk SatinSheet PillowCase (2D)

IM4117S	SatinSheet 2Direction PillowCase
---------	----------------------------------

Inspektion

Første kontrol:

- Er emballagen intakt?
- Kontrollér label på emballagen, og kontrollér artikelnummeret og produktnavn.
- Tjek, at "Short Instruction" er vedlagt – opdateret Manual kan downloades fra www.etac.dk, eller kontakt Etacs kundeservice.
- Kontrollér label på produktet – findes artikelnummer, produktnavn, lot-/batchnummer og vaskeanvisning samt producent.
-

Gentagende inspektion:

- Kontrollér, at deres manuelle transfer system eller hjælpemiddel er i en perfekt stand.
- Efter vask – kontrollér altid materialer, sømme, syninger, håndtag og spænder.
- Viser produktet tegn på slitage, skal produktet straks kasseres.



Visuel inspektion/tjek produktet:

Kontrollér, at materialer, sømme, syninger, håndtag og spænder er intakte.l.



Stabilitetstest:

Prøv at bøje produktet; verificer, at det føles solidt og stabilt.



Mekanisk test/tjek håndtag:

Træk i håndtagene i hver sin retning, og kontrollér materialer, sømme og syninger.

Test spændet:

Lås spændet, og træk i hver sin retning; kontrollér spændet, sømme og syninger.



Test lav/høj friktion:

Placer produktet på en fast overflade eller sengen, placer hænderne på materialet og test friktionen ved at skubbe hænderne ned og fremad i produktet.

Lav friktion – glider uden problemer.
Høj friktion – glider ikke.

Kontroller:

Manuelle transferprodukter med håndtag, stropper og spænder:



Manuelle transferprodukter til siddende og liggende forflytninger med lav eller høj friktion:



Produktionsår, -måned og -dag



Produktet bortskaffes i henhold til nationale regler.



Læs brugermanualen

Yleistä

Kiitos, että valitsit Etac-tuotteen.

Lue käyttöohjeet tarkkaan, jotta voit välttää onnettomuudet ja loukkaantumiset tuotteiden siirtämisen ja käsittelyn aikana.

Tässä käyttöohjeessa ”käyttäjä” on henkilö, joka makaa tai istuu tuotteessa. Hoitajat ovat henkilöitä, jotka käsittelevät tuotetta.



Tämä symboli esiintyy tekstissä läpi koko ohjeen. Se kiinnittää lukijan huomion kohtiin, jotka voivat aiheuttaa vaaraa käyttäjän tai hoitajan terveydelle tai turvallisuudelle.

Tuotteet ovat lääkinnällisistä laitteista annetussa Lääkinnällisiä laitteita koskeva asetus (EU) 2017/745 luokkaan 1 kuuluvien tuotestandardien mukaisia.

Pyrimme Etacissa parantamaan tuotteitamme, joten pidätämme oikeuden tehdä muutoksia tuotteisiin ilman ennakkovaroitusta. Kaikki kuvissa ja vastaavassa materiaalisissa esitetyt mitat ovat ohjeellisia, eikä Etac ole vastuussa niissä mahdollisesti olevista virheistä.

Tässä ohjekirjassa annetut tiedot, mukaan lukien suositukset, yhdistelmät ja mitoitus, eivät koske erikoistilauksia ja muunnettuja tuotteita. Jos asiakas tekee muutoksia, korjauksia tai yhdistelmiä, joita Etac ei ole ennalta määrittänyt, Etacin CE-sertifikaatti tai Etac-takuu eivät ole voimassa. Jos olet epävarma, ota yhteys Etaciin.

Takuu: Kahden vuoden takuu materiaali- ja valmistusvirheiden varalta edellyttäen, että tuotetta käytetään oikein.

Arvioitu käyttöikä: Laitteen arvioitu käyttöikä on 1–2 vuotta normaalissa käytössä. Laitteen käyttöikä vaihtelee käyttöiheyden, kuormien ja pesutiheyden ja -tavan mukaan.

Lisätietoja Etac-siirtolaitevalikoimasta saa osoitteesta www.etac.com.

Jos laitteen käytössä ilmenee haittatapahtuma, vaaratilanteet on ilmoitettava paikalliselle jälleenmyyjälle ja kansalliselle toimivaltaiselle viranomaiselle viipymättä. Paikallinen jälleenmyyjä välittää tiedot valmistajalle.

Yleistä symboleista



Pesu



pH-taso / Pyyhittävä



Varoitus



Valmistaja



Ei saa valkaista



Älä koskaan jätä lattialle



Valmistusvuosi, -kuukausi ja -päivä
YYYY-MM-DD



CE-merkintä



Kuivausrumpu sallittu



Alas liukumisen vaara



Eränumero



Pidä kuivana



Silitys



Pidettävä poissa auringonvaloista



Käyttäjän massaraja = suurin sallittu kuormitus
max 150 kg / max 330 lbs



Ei-steriili



Ei saa kuivapestä



Lue käyttöohje



Tuotteen voi romuttaa kansallisten määräysten mukaisesti.



Tuotenumero



Lääkinnällinen laite

Käyttötarkoitus

SatinSheet 4Direction on DrawSheet-lakana, jota käytetään BaseSheet-lakanan kanssa (SatinSheet BaseSheet 2Direction). SatinSheet-järjestelmää käytetään käyttäjän uudelleenaseoimiseen ja kääntämiseen sängyssä.

Käyttöympäristö

Akuutti hoito, pitkäaikaishoito, kotihoito

Sijoittaminen

Aseta SatinSheet BaseSheet -lakana matalakitkainen materiaali (satiini) ylöspäin vuoteen keskelle (kuvat). Vetolakana voidaan tarvittaessa asettaa SatinSheet-lakanalle.

Kaikissa SatinSheet-malleissa on tämä puoli ylöspäin -merkintä, joka osoittaa kumpi puoli lakanasta tulee vuoteeseen ylöspäin. Kaikkiin SatinSheet-malleihin/-tuotteisiin on ommeltu tarra, jossa kuvataan tuotteen asianmukainen käyttö.

Aseta SatinSheet 4Direction -lakana BaseSheet-lakanalle (satiinipinta satiinia vasten).

Lakanan mahdolliset rypyt on oioitava ennen reunojen taittamista patjan alle, jotta makuuhaavariskiltä vältytään. Hoitajat vetävät molemmilta sivuilta samanaikaisesti ja poikittain.

Käyttö

Kääntäminen SatinSheet 4Direction -lakanan avulla (kuvat 1–3)

Käytä aina SatinSheet 4Direction -lakanaa jonkin SatinSheet-lakanan kanssa.

SatinSheet 4Direction -lakana on valmistettu matalakitkaisesta materiaalista. Se sopii ihanteellisesti bariatristen käyttäjien hoitoon. SatinSheet 4Direction -lakanalla tehtävä kääntämistoimenpide on sama kuin SatinSheet- ja vetolakanaalla tehtävä kääntäminen.

Käyttäjän kääntäminen vuoteessa: Tartu vetolakanaan lantioiden ja hartioiden kohdalta. Hoitajan on tartuttava kankaaseen mahdollisimman laajalta alueelta, jotta otteesta tulee ergonomisempi.

Työskentele aina ranteet suorina ja painonsiirtoa hyödyntäen. Käyttäjää voidaan kääntää SatinSheet-lakanalla myös kahden hoitajan voimin. Hoitajat tekevät yhteistyötä niin, että yksi hoitaja auttaa vetämään SatinSheet-lakanaa samalla, kun toinen painaa patjaa alaspäin käyttäjän lanteiden ja hartioiden kohdalta ja työntää varovasti.

Jos käytetään lenkeillä varustettua SatinSheet 4Direction -lakanaa, käyttäjän voi kääntää liinalla. Verkkolenkit asetetaan liinatangon koukkuihin ja käyttäjää käännetään hitaasti (kuvat 4 ja 5). Tukityyny tai kiila asetetaan käyttäjän selän tueksi ja liina lasketaan hitaasti takaisin alas. Lenkit irrotetaan liinatangon koukuista. Nosta tarvittaessa sängynlaidat.

Käännä käyttäjä.

Liukumekanismien lukitseminen kääntämisen jälkeen: Taita DrawSheet-lakanan reunat patjan alle vuoteen kummaltakin puolelta.

Käyttäjän siirtäminen ylemmäs vuoteessa (kuva 6)

Siirrä käyttäjää ylemmäs vuoteessa tarttumalla SatinSheet 4Direction -lakanan käyttäjän hartioiden molemmilta puolilta. Tämän jälkeen hoitaja vetää lakanasta jalkaansa nojaten ja painonsiirtoa käyttäen.

Istuvaan asentoon nouseminen SatinSheet 4Direction -lakanan avulla (kuvat 7 ja 8)

Jotta estetään käyttäjän valuminen alas, kun hän istuu

vuoteessa, osa SatinSheet 4Direction -lakanasta voidaan taittaa käyttäjän alle. Taita SatinSheet patjan alle, kuitenkin vain lonkan kohdalta. Sängyn päätypuolta voi tämän jälkeen nostaa SatinSheet toimii tässä jarruna.

Potilaan asettaminen päinmakuulle

Irrota sängyn pääty. Jos käyttäjä on liitetty hengityskoneeseen tai muuhun hengenpelastuskoneeseen, käännä käyttäjä laitetta kohti. Aseta käyttäjän käsi lantion alle. Lisää tarvittaessa 2-3 tyynyä tai asentotyynyä käyttäjän kehon päälle. Aseta SatinSheet4Direction tyynyjen päälle niin, että satiini osoittaa ylöspäin, alkaen pään puoleisesta päädyestä – taita 4Directionin reuna pois päin käyttäjän päästä. Kiedo SatinSheet4Direction käyttäjän ympärille "koteloksi". Taita alemman 4Direction-lakanan reuna pois päin käyttäjän päästä (satiini vasten satiinia) Yksi hoitaja tukee käyttäjän päätä ja yksi hoitaja kummallakin puolella tukee käyttäjää. Siirrä käyttäjä kääntymissuuntaan nähden vastakkaiselle puolelle. Aseta käyttäjän alla olevan SatinSheet4Direction-lakanan nostolenkit nostotangon koukkuihin ja käännä käyttäjä hitaasti lähes 90° astetta (kuva 9). Työnnä ja vedä SatinSheet4direction-lakanaa varmistaaksesi, että käyttäjä kääntyy suorassa linjassa. Kun käyttäjä on sivunmakuulla, yksi hoitaja työntää alla olevan SatinSheet4Direction-lakanan reunan käyttäjän alle, jotta sen voi poistaa, kun käyttäjä on käännetty päinmakuulle. Sama hoitaja tukee käyttäjää pidellen häntä olkapäästä. Jatka käyttäjän kääntämistä, kunnes käyttäjä on päinmakuulla. Laske nostolaite uudelleen. Poista lenkit nostotangon koukuista ja poista SatinSheet4Direction. Suorista 4Direction-lakanan reuna käyttäjän pään alla. Tarvittaessa siirrä käyttäjä keskelle sänkyä. Varmista, että käyttäjä on oikeassa asennossa (kuva 10). Nosta sängyn kiskot tarvittaessa. Käännä selinmakuulle samalla tavalla.

Huomautus

Erityisominaisuudet

Tarkista aina tuote ennen pesua ja sen jälkeen.

Viallista tuotetta ei saa käyttää. Jos tuotteessa ilmenee kulumisen merkkejä, se on heti poistettava käytöstä.

Lue nämä ohjeet huolellisesti.

On tärkeää, että hoitajat saavat opastusta käsin tapahtuvasta käsittelystä. Etac tarjoaa neuvontaa ja koulutusta hoitajille. Lisätietoja saat ottamalla yhteyden Etaciin.

Käytä aina oikeaa käsittelytekniikkaa

Rohkaise käyttäjää auttamaan, kun mahdollista.

Varmista, että käyttäjä tuntee olonsa turvalliseksi ja että jokainen manuaalinen käsittely tapahtuu sujuvasti. Suunnittele aina manuaalinen käsittely etukäteen.



On olemassa vaara, että käyttäjä liukuu pois tuotteen päältä. Älä koskaan jätä käyttäjää yksin sängyn reunalle.



Älä koskaan jätä tuotetta lattialle.



Tee aina riskinarviointi ja varmista, että avustavaa tuotetta voidaan käyttää yksittäisen käyttäjän kohdalla ja yhdessä muiden laitteiden kanssa niin, että se on turvallista sekä käyttäjälle ja hoitajille.



On suositeltavaa, että sängynlaita on paikallaan, jos käyttäjä jätetään liukujärjestelmän päälle, ellei riskinarvioinnissa ole havaittu, että käyttäjä voidaan turvallisesti jättää liukujärjestelmän päälle ilman sängynlaitoja.



Lukitse liukujärjestelmä aina, kun siirto on tehty.

Jos olet epävarma, ota yhteys Etaciin.

Materiaali ja puhdistus

Materiaali:

SatinSheet 4Direction:

Polypuuvilla: 55% puuvillaa/45% polyesteriä.

Satiini: Polyesteriä.

SatinSheet In2Sheet 4Direction:

Mikrokuitu, päällys: Polyesteriä

Keskikerros: 65% polyesteriä/35% viskoosia

Sulku: Polyuretaania

Liukualue: Polyesteriä

Lenkit: Nylonia

Siivet: 55% puuvillaa/45% polyesteriä.

Imukyky: 2 200 ml/m².

Tuote on tarkistettava säännöllisesti, mieluiten joka kerta kun sitä käytetään ja erityisesti pesun jälkeen.

Tarkista, ettei saumoissa tai kankaassa ole vaurioita.



Älä koskaan yritä korjata tuotetta itse.
Viallista tuotetta ei saa käyttää.



Tuotteen pesu ennen käyttöä on suositeltavaa.

Pesuohteet:

Silitäminen parantaa liukuominaisuuksia.

Älä käytä huuhteluainetta.

Tuote voidaan puhdistaa pesuaineella, joka ei sisällä liuottimia ja jonka pH on 5–9, tai 70-prosenttisella desinfiointiaineella.



Tuotteet ja varusteet

Tuotenumero	Tuotteen kuvaus	Koko (mm)
IM4115S	SatinSheet 4Direction - midi (satin W1470xL1400 mm)	W2000xL1400
IM4115SH	SatinSheet 4Direction w/handles - midi (satin W1470xL1400)	W2000xL1400
IM4121S	SatinSheet 4Direction - maxi (satin W1470xL2000 mm)	W2000xL2000
IM4121SH	SatinSheet 4Direction w/handles - maxi (satin W1470xL2000)	W2000xL2000
IM4131SH	SatinSheet 4Direction w/handles maxi - wide	W3000xL2000
IM4110S	In2Sheet 4Direction w/wings - mini	W850xL900
IM4110SH	In2Sheet 4Direction w/wings + handles - mini	W850xL900
IM4140S	In2Sheet 4Direction w/wings - midi	W1200xL1400
IM4140SH	In2Sheet 4Direction w/wings and handles - midi	W1200xL1400

Setti

Tuote-numero	Kuvaus	SatinSheet 2Direction BaseSheet	SatinSheet DrawSheet and SatinSheet 4Direction
IM4200S	SatinSheet DrawSheet midi set	IM4113S SatinSheet 2Direction midi	IM4118S SatinSheet DrawSheet - midi
IM4201S	SatinSheet DrawSheet mini set	IM4108S SatinSheet 2Direction mini	IM4116S SatinSheet DrawSheet - mini
IM4202S	SatinSheet DrawSheet maxi midi set	IM4114S SatinSheet 2Direction maxi	IM4118S SatinSheet DrawSheet - midi
IM4203S	SatinSheet 4Direction Fit midi set	IM4112S SatinSheet 2Direction FIT	IM4115S SatinSheet 4Direction - midi
IM4204S	SatinSheet 4Direction midi set	IM4113S SatinSheet 2Direction midi	IM4115S SatinSheet 4Direction - midi
IM4205S	SatinSheet DrawSheet midi small set	IM4119S SatinSheet 2Direction midi small	IM4118S SatinSheet DrawSheet - midi
IM4207S	SatinSheet 4Direction midi small set	IM4119S SatinSheet 2Direction midi small	IM4115S SatinSheet 4Direction - midi
IM4208S	SatinSheet Corner DrawSheet midi set	IM4107S SatinSheet 2Direction w/elastic	IM4118S SatinSheet DrawSheet - midi
IM4209S	SatinSheet In2Sheet midi mini set	IM4119S SatinSheet 2Direction midi small	IM4110S In2Sheet 4Direction w/wings - mini
IM4210S	SatinSheet In2Sheet mini set	IM4108S SatinSheet 2Direction mini	IM4110S In2Sheet 4Direction w/wings - mini
IM4211S	SatinSheet Corner 4Direction midi set	IM4107S SatinSheet 2Direction w/elastic	IM4115S SatinSheet 4Direction - midi
IM4212S	SatinSheet Corner 4Direction maxi set	IM4107S SatinSheet 2Direction w/elastic	IM4121S SatinSheet 4Direction - maxi
IM4213S	SatinSheet 4Direction maxi set	IM4114S SatinSheet 2Direction maxi	IM4121S SatinSheet 4Direction - maxi
IM4214S	SatinSheet 4Direction maxi set - wide	IM4177S SatinSheet 2direction maxi - wide	IM4121S SatinSheet 4Direction - maxi
IM4215S	SatinSheet 4Direction maxi set - double	IM4180S SatinSheet 2Direction maxi - double	IM4121S SatinSheet 4Direction - maxi
IM4216S	SatinSheet 4Direction midi set - wide	IM4176S SatinSheet 2direction midi - wide	IM4115S SatinSheet 4Direction - midi
IM4217S	SatinSheet 4Direction midi set - double	IM4179S SatinSheet 2direction midi - double	IM4115S SatinSheet 4Direction - midi
IM4218S	SatinSheet 4Direction maxi midi set	IM4114S SatinSheet 2Direction maxi	IM4115S SatinSheet 4Direction - midi
IM4219S	SatinSheet 4Direction maxi midi set - wide	IM4177S SatinSheet 2direction maxi - wide	IM4115S SatinSheet 4Direction - midi
IM4220S	SatinSheet 4Direction maxi midi set - double	IM4180S SatinSheet 2Direction maxi - double	IM4115S SatinSheet 4Direction - midi
IM4221S	SatinSheet DrawSheet maxi midi set - wide	IM4177S SatinSheet 2direction maxi - wide	IM4118S SatinSheet DrawSheet - midi
IM4222S	SatinSheet DrawSheet maxi midi set - double	IM4180S SatinSheet 2Direction maxi - double	IM4118S SatinSheet DrawSheet - midi
IM4223S	SatinSheet DrawSheet midi set - wide	IM4176S SatinSheet 2direction midi - wide	IM4118S SatinSheet DrawSheet - midi
IM4224S	SatinSheet DrawSheet midi set - double	IM4179S SatinSheet 2direction midi - double	IM4118S SatinSheet DrawSheet - midi
IM4225S	SatinSheet Corner 4Direction midi set - wide	IM4147S SatinSheet 2Direction w/elastic-wide	IM4115S SatinSheet 4Direction - midi
IM4226S	SatinSheet Corner 4Direction midi set - double	IM4137S SatinSheet 2Direction w/elastic-double	IM4115S SatinSheet 4Direction - midi
IM4227S	SatinSheet Corner DrawSheet midi set - wide	IM4147S SatinSheet 2Direction w/elastic - wide	IM4118S SatinSheet DrawSheet - midi
IM4228S	SatinSheet Corner DrawSheet midi set - double	IM4137S SatinSheet 2Direction w/elastic-double	IM4118S SatinSheet DrawSheet - midi
IM4229S	SatinSheet Corner 4Direction maxi set - wide	IM4147S SatinSheet 2Direction w/elastic - wide	IM4121S SatinSheet 4Direction - maxi
IM4230S	SatinSheet Corner 4Direction maxi set - double	IM4137S SatinSheet 2Direction w/elastic - double	IM4121S SatinSheet 4Direction - maxi
IM4231S	SatinSheet Corner 4Direction w/handle midi set	IM4107S SatinSheet 2Direction w/elastic	IM4115SH SatinSheet 4Direction w/handles - midi
IM4251S	SatinSheet 4Direction maxi midi set - small		

Yhdistelmät

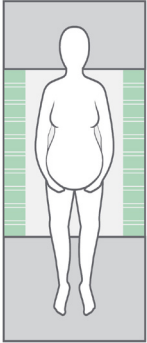

Article no.	BaseSheet - Mini
IM4133S	SatinSheet 2Direction mini - small
IM4108S	SatinSheet 2Direction mini
IM4175S	SatinSheet 2Direction mini - wide
IM4178S	SatinSheet 2Direction mini - double
BaseSheet - Mini voidaan yhdistää seuraaviin:	
Article no.	DrawSheet, 4Direction and PillowCase
IM4116S	SatinSheet drawSheet - mini
IM4110S	In2Sheet 4Direction w/wings - mini
IM4110SH	In2Sheet 4Direction w/wings + handles - mini
IM4117S	SatinSheet 2Direction PillowCase

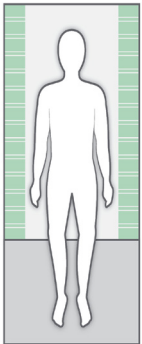

Article no.	BaseSheet - Midi
IM4119S	SatinSheet 2Direction midi small
IM4113S	SatinSheet 2Direction midi
IM4176S	SatinSheet 2Direction midi - wide
IM4179S	SatinSheet 2Direction midi - double
BaseSheet - Midi voidaan yhdistää seuraaviin:	
Article no.	DrawSheet, 4Direction and PillowCase
IM4118S	SatinSheet DrawSheet - midi
IM4115S	SatinSheet 4Direction - midi
IM4115SH	SatinSheet 4Direction w/handles - midi
IM4121S	SatinSheet 4Direction - maxi
IM4121SH	SatinSheet 4Direction w/handles - maxi
IM4117S	SatinSheet 2Direction PillowCase

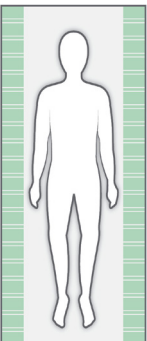

Article no.	BaseSheet - Maxi
IM4181S	SatinSheet 2Direction maxi - small
IM4114S	SatinSheet 2Direction maxi
IM4177SH	SatinSheet 2Direction maxi - wide
IM4180S	SatinSheet 2Direction maxi - double
IM4122S	SatinSheet 2Direction 180cm bed
Article no.	BaseSheet - Maxi Corner
IM4107S	SatinSheet 2Direction Corner
IM4147S	SatinSheet 2Direction Corner - wide
IM4137S	SatinSheet 2Direction Corner - double
Article no.	BaseSheet - Maxi Fit
IM4112S	SatinSheet 2Direction Fit
IM4142S	SatinSheet 2Direction Elastic Fit
Article no.	BaseSheet - Mini, Midi and Maxi Corner
IM4167S	SatinSheet 2Direction Corner - small -mini
IM4157S	SatinSheet 2Direction Corner - midi
IM4197S	SatinSheet 2Direction Corner - double - double - maxi
BaseSheet - Maxi/Corner/Fit voidaan yhdistää seuraaviin:	
Article no.	4Direction and In2Sheet 4Direction
M4115S	SatinSheet 4Direction - midi
IM4115SH	SatinSheet 4Direction w/handles - midi
IM4140S	In2Sheet 4Direction w/wings - midi
IM4140SH	In2Sheet 4Direction - w/wings + handles - midi
IM4121S	SatinSheet 4Direction - maxi
IM4121SH	SatinSheet 4Direction w/handles - maxi

Muista SatinSheet PillowCase (2D)

IM4117S	SatinSheet 2Direction PillowCase
---------	----------------------------------

Tarkistus

Ensimmäinen tarkistus:

- Onko pakkaus ehjä?
- Lue pakkauksen etiketti ja tarkista tuotenro ja -kuvaus.
- Tarkista, että lyhyt ohje on mukana – päivitetyn käyttöohjeen voi ladata osoitteesta www.etac.com tai pyytää asiakaspalvelusta tai paikalliselta jälleenmyyjältä.
- Tarkista tuotteessa oleva etiketti – onko siinä tuotenro, tuotokuvaus, erän nro, puhdistusohje ja toimittajan nimi?

Määräaikaistarkistus:

- Varmista, että manuaalinen siirtojärjestelmä on aina täydellisessä kunnossa.
- Tarkista pesun jälkeen aina materiaalit, ompeleet, lenkit/kahvat, soljet.
- Jos tuotteessa ilmenee kulumisen merkkejä, se on heti poistettava käytöstä.



Silmämääräinen tarkistus / Tarkista tuote:

Varmista, että materiaalit, saumat, ompeleet, lenkit/kahvat ja soljet ovat ehjiä/virheettömiä.



Vakaustesti:

Yritä taivuttaa tuotetta ja varmista, että se tuntuu lujalta, vakaalta ja kiinteältä.



Mekaaninen kuormitus tai jännitys / testaa lenkit/kahvat:

Vedä lenkeistä kovaa vastakkaisiin suuntiin ja tarkista materiaali, saumat ja ompeleet.

Testaa soljet:

Lukitse solki ja vedä vastakkaisiin suuntiin, tarkista solki ja ompeleet.

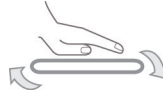

Testaa pieni/suuri kitka:

Aseta tuote kiinteälle pinnalle tai vuoteelle, aseta kätesi materiaalin päälle ja testaa kitka painamalla käsiäsi alaspäin tuotteen sisään.

Pieni kitka – liikuu ongelmitta
Suuri kitka – ei liikua/liikettä

Tarkista:

Manuaaliset siirtovälineet, joihin kuuluu lenkkejä/kahvoja, silmukoita ja solkia:



Manuaaliset siirtovälineet siirtoihin istuma-asennossa ja makuuasennossa suuri- tai pienikitkaiset:

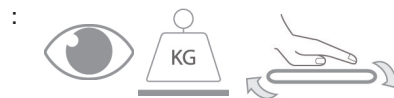

Valmistusvuosi, -kuukausi ja -päivä



Tuotteen voi romuttaa kansallisten määräysten mukaisesti



Lue käyttöohje

Allgemeines

Vielen Dank, dass Sie sich für ein Produkt von Etac entschieden haben.

Um Unfälle und Verletzungen beim Handhaben und Verwenden des Produkts zu vermeiden, sollten Sie diese Anleitung sorgfältig durchlesen.

Mit „Benutzer“ wird in dieser Anleitung die Person bezeichnet, die auf dem Produkt sitzt oder liegt. Unter „Helfer“ wird die Person verstanden, die das Produkt handhabt.



Dieses Symbol erscheint neben dem Text in der Bedienungsanleitung. Es macht den Leser auf Situationen aufmerksam, die eine Gefahr für die Gesundheit und Sicherheit des Benutzers oder Helfers darstellen können.

Das Produkt erfüllt die Anforderungen der geltenden Normen für Produkte der Klasse 1 im Einklang mit der Verordnung über Medizinprodukte (EU) 2017/745 über Medizinprodukte.

Bei Etac sind wir bemüht, unsere Produkte laufend zu verbessern und behalten uns daher das Recht vor, Änderungen ohne vorherige Ankündigung durchzuführen. Alle Abmessungen auf Abbildungen o. Ä. sind lediglich als Richtwerte zu verstehen und Etac haftet nicht für Fehler und Mängel.

Die in dieser Anleitung aufgeführten Angaben einschließlich

der Empfehlungen, Kombinationen und Größen gelten nicht für Sonderbestellungen und Modifikationen. Nimmt der Kunde Anpassungen, Reparaturen oder Kombinationen vor, die nicht von Etac spezifiziert wurden, wird die CE-Zertifizierung ungültig und die Garantieverpflichtung von Etac erlischt. Bei Fragen wenden Sie sich bitte an Etac.

Garantie: Zwei-Jahres-Garantie auf Material- und Herstellungsfehler, vorausgesetzt, dass das Produkt ordnungsgemäß verwendet wird.

Voraussichtliche Lebensdauer: Das Gerät hat bei normalem Gebrauch eine voraussichtliche Lebensdauer von 1 bis 2 Jahren. Die Lebensdauer des Geräts variiert und hängt von der Häufigkeit des Gebrauchs, der Belastung sowie von der Art und Häufigkeit der Reinigung ab.

Weitere Informationen über das Angebot von Etac siehe www.etac.com.

Alle unerwünschten Ereignisse, die im Zusammenhang mit dem Gerät auftreten, sollten unverzüglich Ihrem Händler vor Ort sowie der zuständigen Behörde gemeldet werden. Der Händler vor Ort leitet die Informationen an den Hersteller weiter.

Symbole allgemein



Waschen



pH-Wert / Abwischen



Warnung



Hersteller



Nicht bleichen



Niemals auf dem Boden liegen lassen!



Herstellungsjahr, -monat und -tag



CE-Kennzeichnung



Im Wäschetrockner trocknen



Rutschgefahr



Batch-Nr./Lot-Nr.



Trocken halten



Bügeln



Keiner Sonnenstrahlung aussetzen!



Höchstgewicht des Benutzers = maximale Gewichtsbelastung



Nicht steril



Nicht chemisch reinigen



Bedienungsanleitung lesen



Das Produkt kann in Übereinstimmung mit den geltenden nationalen Vorschriften entsorgt werden.



Artikelnummer



Medizinprodukt

Zweckbestimmung

Das SatinSheet 4Direction ist ein Zuglaken zur Verwendung mit einem BaseSheet (SatinSheet BaseSheet 2Direction). Das SatinSheet-System wird zur Umlagerung und Drehung eines Pflegebedürftigen im Bett verwendet.

Vorgesehener Einsatzbereich

Akutbehandlung, Langzeitpflege, Hauspflege

Positionierung

Das SatinSheet BaseSheet mit dem reibungsarmen Material nach oben in der Mitte des Bettes ausbreiten (Abb.). Bei Bedarf kann ein Zuglaken über das SatinSheet gelegt werden. Alle SatinSheet-Modelle haben ein Etikett mit dem Text „this side up“, mit dem die Seite im Bett nach gekennzeichnet ist, die nach oben auszurichten ist. Ein Informationsetikett mit einer Beschreibung der richtigen Verwendung des Produktes wird in alle SatinSheet-Modelle/-Produkte eingenäht.

Platzieren Sie das Stecklaken SatinSheet 4Direction auf dem Bettlaken Basesheet (Satin auf Satin).

Vor der Sicherung des Gleitsystems unter der Matratze sollten alle Unebenheiten/Falten zur Vermeidung von Dekubitus geglättet werden. Die Helfer ziehen gleichzeitig und diagonal von beiden Seiten.

Verwendung

Umdrehen mit SatinSheet 4Direction (Abb. 1-3)

SatinSheet 4Direction ist immer mit einem der SatinSheet-Modelle zu verwenden.

Die Rückseite von SatinSheet 4Direction besteht aus reibungsarmem Material. Dieses eignet sich ideal für übergewichtige Benutzer. Das Umdrehen mit SatinSheet 4Direction entspricht dem Ablauf mit dem SatinSheet in Verbindung mit einem Zuglaken.

Umdrehen des Benutzers im Bett: Das Zuglaken an Hüfte und Schultern ergreifen. Um einen ergonomisch gute Griffigkeit zu erzielen, sollte der Helfer möglichst viel Stoff zu ergreifen versuchen.

Immer mit gestreckten Handgelenken und Gewichtsverlagerung arbeiten.

Das Umdrehen mit dem SatinSheet kann auch von zwei Helfern vorgenommen werden. Diese arbeiten wie folgt zusammen: Ein Helfer zieht am SatinSheet, während der andere die Matratze an Hüfte und Schultern des Benutzers herabzieht und sanft schiebt.

Wenn Sie das SatinSheet 4Direction mit Handschlaufen nutzen, können Sie den Nutzer mit einem Lifter wenden. Befestigen Sie die Handschlaufen in der Lifteraufhängung (Abbildung 4+5) und wenden Sie den Nutzer langsam. Platzieren Sie ein Lagerungskissen oder einen Positionierungskeil, um den Rücken zu unterstützen und senken Sie den Lifter wieder langsam. Entnehmen Sie die Schlaufen aus der Aufhängung. Nutzen Sie die Bettgitter bei Bedarf.

Den Benutzer umdrehen.

Sicherung des Gleitsystems nach dem Umdrehen:
Den überschüssigen Stoff des DrawSheet auf beiden Seiten des Bettes unter die Matratze ziehen.

Positionierung des Benutzers höher im Bett (Abb. 6)

Um den Benutzer weiter nach oben im Bett zu verlegen, ist das SatinSheet 4Direction auf beiden Seiten der Schultern des Benutzers zu ergreifen. Mit einem Fuß vor dem anderen zieht der Helfer mit Gewichtsverlagerung am Laken.

Aufrichten im Bett mit dem SatinSheet 4Direction (Abb. 7 und 8)

Damit der Benutzer im Bett nicht nach unten rutscht, wenn er

sich aufrichtet, kann ein Teil des SatinSheet 4Direction unter dem Benutzer eingefaltet werden. Danach ist das SatinSheet unter die Matratze zu stecken, allerdings nur an der Hüfte. Der Bettkopf kann daraufhin angehoben werden. In diesem Fall funktioniert das SatinSheet wie eine Bremse.

Verbringen in die Bauchlage

Das Kopfende vom Bett abnehmen. Wenn der Pflegebedürftige an ein Beatmungsgerät oder andere lebenserhaltende Geräte angeschlossen ist, den Pflegebedürftigen zum Gerät drehen. Die Hand des Pflegebedürftigen unter dessen Hüfte legen. Ggf. 2 oder 3 oder die Positionierungskissen, die oben auf dem Körper des Pflegebedürftigen verwendet werden. Ein SatinSheet4Direction auf die Kissen legen, wobei die Satinseite oben liegt, dann das SatinSheet4Direction am Kopfende beginnend vom Kopf des um den Pflegebedürftigen einstecken. Das untere 4Direction vom Kopf des Pflegebedürftigen wegfallen (Satin auf Satin) Eine Pflegeperson sichert den Kopf des Pflegebedürftigen und jeweils eine Pflegeperson befindet sich an jeder Seite zur Unterstützung des Pflegebedürftigen. Bewegen Sie den Pflegebedürftigen auf die Seite, die der Seite, auf die der Pflegebedürftige gedreht werden soll, gegenüberliegt. Die Griffschlaufen des SatinSheet4Direction, auf dem der Pflegebedürftige liegt, in die Haken des Hebebügels einlegen und den Pflegebedürftigen langsam um fast 90° (Abbildung 9) drehen, dabei das SatinSheet4Direction etwas ziehen und schieben, damit die. Wenn der Pflegebedürftige auf der Seite liegt, steckt eine Pflegekraft das SatinSheet4Direction auf dem Bett unter den Pflegebedürftigen, damit es herausgenommen werden kann, nachdem der Pflegebedürftige in die Bauchlage gedreht wurde. Dieselbe Pflegekraft unterstützt den Pflegebedürftigen, indem sie die Hände auf dessen Schulter legt. Den Pflegebedürftigen weiter drehen, bis sich der Pflegebedürftige in der Bauchlage befindet. Den Lifter wieder absenken. Die Griffschlaufen wieder aus den Haken des Hebebügels nehmen und das SatinSheet4Direction entfernen. Das SatinSheet4Direction unter dem Kopf des Pflegebedürftigen entfalten. Den Pflegebedürftigen ggf. mittig im Bett platzieren. Der Pflegebedürftige muss richtig positioniert sein (Abbildung 10). Falls erforderlich, Bettgitter hochziehen. In gleicher Weise in die Rückenlage bringen.

Hinweis

Besondere Hinweise

Das Produkt vor dem Gebrauch und nach dem Waschen überprüfen.

Niemals ein defektes Produkt verwenden! Produkte, die Anzeichen von Abnutzung zeigen, müssen entsorgt werden.

Diese Hinweise sind sorgfältig durchzulesen.

Es ist wichtig, dass sämtliche Helfer eine Einweisung in die Handhabung des Produkts erhalten. Etac bietet Beratung und Schulungen für Helfer an. Weitere Informationen erhalten Sie bei Etac.

Auf die richtige Umsetz-/Umlagerungstechnik achten.

Der Benutzer ist aufzufordern, nach Möglichkeit Hilfe zu leisten.

Planen Sie den Vorgang stets im Voraus, damit alle Schritte reibungslos ablaufen und der Benutzer sich sicher fühlt.



Es besteht die Gefahr, dass der Benutzer abgleitet. Den Benutzer niemals allein auf der Bettkante zurücklassen!



Das Produkt niemals auf dem Boden liegen lassen!



Immer eine Risikobeurteilung vornehmen und sicherstellen, dass das Hilfsprodukt beim jeweiligen Benutzer und in Kombination mit anderen Geräten so verwendet werden kann, dass es für Benutzer und Helfer/Pfleger sicher ist.



Es empfiehlt sich, das Bettgitter nicht zu entfernen, wenn der Benutzer sich auf dem Gleitsystem befindet, sofern nicht im Rahmen einer Risikobeurteilung festgestellt wurde, dass der Benutzer ohne Bettgitter sicher auf dem Gleitsystem verbleiben kann.



Das Gleitsystem nach Abschluss der Verlegung immer befestigen.

Bei Fragen wenden Sie sich bitte an Etac.

Material und Reinigung

Material:

SatinSheet 4Direction:

Poly-Baumwolle: 55 % Baumwolle, 45 % Polyester

Satin: Polyester.

SatinSheet In2Sheet 4Direction:

Oberseite Mikrofaser: Polyester

Mittlere Schicht: 65% Polyester, 35% Viskose

Barriere: Polyurethan

Gleitbereich: Polyester

Griffe: Nylon

Flügel: 55 % Baumwolle, 45 % Polyester.

Absorbierung: 2000 ml/m²

Das Produkt sollte regelmäßig überprüft werden, möglichst bei jeder Verwendung und vor allem nach dem Waschen.

Es ist sicherzustellen, dass an Nähten oder im Stoff keinerlei Schäden vorliegen.



**Niemals versuchen, ein Produkt eigenhändig zu reparieren.
Niemals ein defektes Produkt verwenden!**



Es ist empfehlenswert, dass Produkt vor der ersten Nutzung zu waschen.

Waschanleitung:

Bügeln verstärkt den Gleiteffekt.

Keinen Weichspüler verwenden.

Das Produkt kann mit einem lösungsmittelfreien Mittel mit einem pH-Wert von 5-9 oder einer 70%igen Desinfektionslösung gereinigt werden.



Produkte und Zubehör

Artikel-Nr.	Beschreibung	Größe (mm)
IM4115S	SatinSheet 4Direction - midi (satin W1470xL1400 mm)	W2000xL1400
IM4115SH	SatinSheet 4Direction w/handles - midi (satin W1470xL1400)	W2000xL1400
IM4121S	SatinSheet 4Direction - maxi (satin W1470xL2000 mm)	W2000xL2000
IM4121SH	SatinSheet 4Direction w/handles - maxi (satin W1470xL2000)	W2000xL2000
IM4131SH	SatinSheet 4Direction w/handles maxi - wide	W3000xL2000
IM4110S	In2Sheet 4Direction w/wings - mini	W850xL900
IM4110SH	In2Sheet 4Direction w/wings + handles - mini	W850xL900
IM4140S	In2Sheet 4Direction w/wings - midi	W1200xL1400
IM4140SH	In2Sheet 4Direction w/wings and handles - midi	W1200xL1400

Set

Artikel-Nr.	Beschreibung	SatinSheet 2Direction BaseSheet	SatinSheet DrawSheet and SatinSheet 4Direction
IM4200S	SatinSheet DrawSheet midi set	IM4113S SatinSheet 2Direction midi	IM4118S SatinSheet DrawSheet - midi
IM4201S	SatinSheet DrawSheet mini set	IM4108S SatinSheet 2Direction mini	IM4116S SatinSheet DrawSheet - mini
IM4202S	SatinSheet DrawSheet maxi midi set	IM4114S SatinSheet 2Direction maxi	IM4118S SatinSheet DrawSheet - midi
IM4203S	SatinSheet 4Direction Fit midi set	IM4112S SatinSheet 2Direction FIT	IM4115S SatinSheet 4Direction - midi
IM4204S	SatinSheet 4Direction midi set	IM4113S SatinSheet 2Direction midi	IM4115S SatinSheet 4Direction - midi
IM4205S	SatinSheet DrawSheet midi small set	IM4119S SatinSheet 2Direction midi small	IM4118S SatinSheet DrawSheet - midi
IM4207S	SatinSheet 4Direction midi small set	IM4119S SatinSheet 2Direction midi small	IM4115S SatinSheet 4Direction - midi
IM4208S	SatinSheet Corner DrawSheet midi set	IM4107S SatinSheet 2Direction w/elastic	IM4118S SatinSheet DrawSheet - midi
IM4209S	SatinSheet In2Sheet midi mini set	IM4119S SatinSheet 2Direction midi small	IM4110S In2Sheet 4Direction w/wings - mini
IM4210S	SatinSheet In2Sheet mini set	IM4108S SatinSheet 2Direction mini	IM4110S In2Sheet 4Direction w/wings - mini
IM4211S	SatinSheet Corner 4Direction midi set	IM4107S SatinSheet 2Direction w/elastic	IM4115S SatinSheet 4Direction - midi
IM4212S	SatinSheet Corner 4Direction maxi set	IM4107S SatinSheet 2Direction w/elastic	IM4121S SatinSheet 4Direction - maxi
IM4213S	SatinSheet 4Direction maxi set	IM4114S SatinSheet 2Direction maxi	IM4121S SatinSheet 4Direction - maxi
IM4214S	SatinSheet 4Direction maxi set - wide	IM4177S SatinSheet2direction maxi - wide	IM4121S SatinSheet 4Direction - maxi
IM4215S	SatinSheet 4Direction maxi set - double	IM4180S SatinSheet 2Direction maxi - double	IM4121S SatinSheet 4Direction - maxi
IM4216S	SatinSheet 4Direction midi set - wide	IM4176S SatinSheet2direction midi - wide	IM4115S SatinSheet 4Direction - midi
IM4217S	SatinSheet 4Direction midi set - double	IM4179S SatinSheet2direction midi - double	IM4115S SatinSheet 4Direction - midi
IM4218S	SatinSheet 4Direction maxi midi set	IM4114S SatinSheet 2Direction maxi	IM4115S SatinSheet 4Direction - midi
IM4219S	SatinSheet 4Direction maxi midi set - wide	IM4177S SatinSheet2direction maxi - wide	IM4115S SatinSheet 4Direction - midi
IM4220S	SatinSheet 4Direction maxi midi set - double	IM4180S SatinSheet 2Direction maxi - double	IM4115S SatinSheet 4Direction - midi
IM4221S	SatinSheet DrawSheet maxi midi set - wide	IM4177S SatinSheet2direction maxi - wide	IM4118S SatinSheet DrawSheet - midi
IM4222S	SatinSheet DrawSheet maxi midi set - double	IM4180S SatinSheet 2Direction maxi - double	IM4118S SatinSheet DrawSheet - midi
IM4223S	SatinSheet DrawSheet midi set - wide	IM4176S SatinSheet2direction midi - wide	IM4118S SatinSheet DrawSheet - midi
IM4224S	SatinSheet DrawSheet midi set - double	IM4179S SatinSheet2direction midi - double	IM4118S SatinSheet DrawSheet - midi
IM4225S	SatinSheet Corner 4Direction midi set - wide	IM4147S SatinSheet 2Direction w/elastic-wide	IM4115S SatinSheet 4Direction - midi
IM4226S	SatinSheet Corner 4Direction midi set - double	IM4137S SatinSheet 2Direction w/elastic-double	IM4115S SatinSheet 4Direction - midi
IM4227S	SatinSheet Corner DrawSheet midi set - wide	IM4147S SatinSheet 2Direction w/elastic - wide	IM4118S SatinSheet DrawSheet - midi
IM4228S	SatinSheet Corner DrawSheet midi set - double	IM4137S SatinSheet 2Direction w/elastic-double	IM4118S SatinSheet DrawSheet - midi
IM4229S	SatinSheet Corner 4Direction maxi set - wide	IM4147S SatinSheet 2Direction w/elastic - wide	IM4121S SatinSheet 4Direction - maxi
IM4230S	SatinSheet Corner 4Direction maxi set - double	IM4137S SatinSheet 2Direction w/elastic - double	IM4121S SatinSheet 4Direction - maxi
IM4231S	SatinSheet Corner 4Direction w/handle midi set	IM4107S SatinSheet 2Direction w/elastic	IM4115SH SatinSheet 4Direction w/handles- midi
IM4251S	SatinSheet 4Direction maxi midi set - small		

Kombinationen

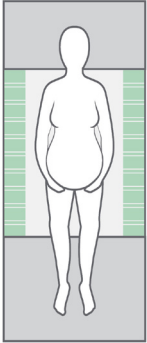

Article no.	BaseSheet - Mini
IM4133S	SatinSheet 2Direction mini - small
IM4108S	SatinSheet 2Direction mini
IM4175S	SatinSheet 2Direction mini - wide
IM4178S	SatinSheet 2Direction mini - double
BaseSheet - Mini ist kombinierbar mit:	
Article no.	DrawSheet, 4Direction and PillowCase
IM4116S	SatinSheet drawSheet - mini
IM4110S	In2Sheet 4Direction w/wings - mini
IM4110SH	In2Sheet 4Direction w/wings + handles - mini
IM4117S	SatinSheet 2Direction PillowCase

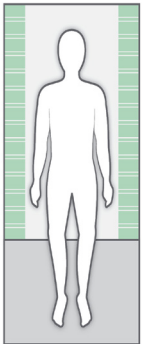

Article no.	BaseSheet - Midi
IM4119S	SatinSheet 2Direction midi small
IM4113S	SatinSheet 2Direction midi
IM4176S	SatinSheet 2Direction midi - wide
IM4179S	SatinSheet 2Direction midi - double
BaseSheet - Midi ist kombinierbar mit:	
Article no.	DrawSheet, 4Direction and PillowCase
IM4118S	SatinSheet DrawSheet - midi
IM4115S	SatinSheet 4Direction - midi
IM4115SH	SatinSheet 4Direction w/handles - midi
IM4121S	SatinSheet 4Direction - maxi
IM4121SH	SatinSheet 4Direction w/handles - maxi
IM4117S	SatinSheet 2Direction PillowCase

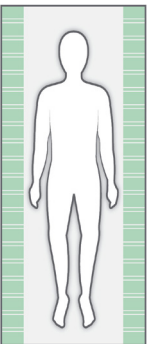

Article no.	BaseSheet - Maxi
IM4181S	SatinSheet 2Direction maxi - small
IM4114S	SatinSheet 2Direction maxi
IM4177SH	SatinSheet 2Direction maxi - wide
IM4180S	SatinSheet 2Direction maxi - double
IM4122S	SatinSheet 2Direction 180cm bed
Article no.	BaseSheet - Maxi Corner
IM4107S	SatinSheet 2Direction Corner
IM4147S	SatinSheet 2Direction Corner - wide
IM4137S	SatinSheet 2Direction Corner - double
Article no.	BaseSheet - Maxi Fit
IM4112S	SatinSheet 2Direction Fit
IM4142S	SatinSheet 2Direction Elastic Fit
Article no.	BaseSheet - Mini, Midi and Maxi Corner
IM4167S	SatinSheet 2Direction Corner - small - mini
IM4157S	SatinSheet 2Direction Corner - midi
IM4197S	SatinSheet 2Direction Corner - double - double - maxi
BaseSheet - Maxi/Corner/Fit ist kombinierbar mit:	
Article no.	4Direction and In2Sheet 4Direction
M4115S	SatinSheet 4Direction - midi
IM4115SH	SatinSheet 4Direction w/handles - midi
IM4140S	In2Sheet 4Direction w/wings - midi
IM4140SH	In2Sheet 4Direction - w/wings + handles - midi
IM4121S	SatinSheet 4Direction - maxi
IM4121SH	SatinSheet 4Direction w/handles - maxi

Denken Sie an das SatinSheet PillowCase (2D)

IM4117S	SatinSheet 2Direction PillowCase
---------	----------------------------------

Inspektionen

Erste Kontrolle:

- Ist die Verpackung unbeschädigt?
- Lesen Sie das Etikett auf der Verpackung und überprüfen Sie Artikelnummer und Produktbeschreibung.
- Überprüfen, ob die Kurzanleitung beigelegt ist - die aktualisierte Bedienungsanleitung kann von www.etac.com heruntergeladen werden oder ist beim Händler vor Ort erhältlich.
- Prüfen Sie das Etikett auf dem Produkt - sind Artikelnummer, Produktbeschreibung, Lot-/Batch-Nr., Reinigungsanleitungen und Anbieter aufgeführt?
-

Regelmäßige Kontrolle:

- Sicherstellen, dass das manuelle Transfer-/Umlagerungssystem immer in perfektem Zustand ist.
- Nach dem Waschen stets Material, Nähte, Griffschlaufen und Schnallen überprüfen.
- Wenn das Produkt Anzeichen von Abnutzung zeigt, darf es nicht mehr benutzt werden.



Inaugenscheinnahme/Produktüberprüfung:

Sicherstellen, dass Material, Nähte, Griffschlaufen und Schnallen unbeschädigt/fehlerfrei sind.



Stabilitätstest:

Das Produkt zu verbiegen versuchen, um zu überprüfen, ob es fest und stabil ist.

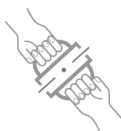

Mechanische Belastung/Griffschlaufen überprüfen:

Fest an den Griffschlaufen ziehen (in entgegengesetzte Richtung) und Material und Nähte überprüfen.

Schnallen überprüfen:

Ziehen Sie an der geschlossenen Schnalle und prüfen Sie Schnalle und Nähte.



Niedrige/hohe Reibung testen:

Das Produkt auf eine feste Unterlage oder ein Bett legen und die Reibung überprüfen, indem die Hände mit Druck über das Produkt gezogen werden.

Niedrige Reibung – müheloses Gleiten
Hohe Reibung – kein Gleiten/Bewegen

Überprüfen:

Manuelle Transfer-/Umlagerungshilfen mit Griffen, Riemen und Schnallen:



Manuelle Transfer-/Umlagerungshilfen für die sitzende und liegende Umlagerung mit hoher oder geringer Reibung:

⋮



Herstellungsjahr, -monat und -tag



Das Produkt kann in Übereinstimmung mit den geltenden nationalen Vorschriften entsorgt werden



Bedienungsanleitung lesen

Algemeen

Dank u dat u voor een van de producten van Etac hebt gekozen.

Lees de handleiding zorgvuldig door, om ongelukken en letsels bij het verplaatsen en hanteren van de producten te voorkomen.

De persoon die in deze gebruikershandleiding als 'de gebruiker' wordt aangeduid, is de persoon die op het product ligt of zit. De term 'verzorgers' wordt gebruikt voor de personen die het product hanteren.



Dit symbool wordt in de handleiding naast de tekst weergegeven. Het maakt de lezer attent op zaken die een gevaar kunnen vormen voor de gezondheid en de veiligheid van de gebruiker of verzorger.

De producten voldoen aan de normen die gelden voor klasse 1-producten verordening betreffende medische hulpmiddelen (EU) 2017/745 betreffende medische hulpmiddelen.

Bij Etac streven we naar voortdurende verbetering van onze producten en daarom behouden we ons het recht voor om onze producten zonder aankondiging vooraf te wijzigen. Alle maten op afbeeldingen en overige referentiematerialen gelden uitsluitend als indicatie en Etac kan niet aansprakelijk worden gesteld voor fouten en afwijkingen.

De informatie in deze handleiding, met inbegrip van aanbevelingen, combinaties en maten, gelden niet voor speciale orders en modificaties. Als de klant aanpassingen of reparaties uitvoert of combinaties maakt die niet vooraf door Etac zijn bepaald, zijn de door Etac aangebrachte CE-markering en de garantie van Etac niet langer geldig. Neem bij twijfel contact op met Etac.

Garantie: twee jaar garantie op materiaal- en productiefouten, op voorwaarde dat het product correct is gebruikt.

Verwachte levensduur: het product heeft bij normaal gebruik een levensduur van 1 à 2 jaar. De levensduur van het product hangt af van hoe vaak het wordt gebruikt, de belasting en hoe vaak en hoe het wordt gewassen.

Ga voor meer informatie over het transferassortiment van Etac naar www.etac.com.

Mocht er een schadelijk incident plaatsvinden met het product, dan moet u dat tijdig melden aan de leverancier van het product en aan de bevoegde autoriteit in uw land. De leverancier geeft de informatie door aan de producent.

Algemene symbolen



Wassen



pH-waarde /Afnemen met een doekje



Waarschuwing



Fabrikant



Niet bleken



Nooit op de vloer laten liggen



Productiejaar, -maand en -dag
YYYY-MM-DD



CE-markering



Drogen in wasdroger



Risico dat de gebruiker naar beneden kan schuiven



Batchnr./Partijnr.



Droog bewaren



Strijken



Niet blootstellen aan zonlicht



Maximale massa gebruiker = maximale nominale belasting



Niet steriel



Niet chemisch reinigen



Lees de gebruikershandleiding



Het product kan worden afgevoerd volgens de nationale voorschriften



Artikelnummer



Medisch hulpmiddel

Beoogd doel

SatinSheet 4Direction is een DrawSheet voor gebruik met BaseSheet (SatinSheet BaseSheet 2Direction). Het SatinSheet-systeem wordt gebruikt om de gebruiker in bed in een andere positie te leggen of te draaien.

Beoogde omgeving

Acute zorg, langdurige zorg, thuiszorg

Plaatsing

Plaats SatinSheet BaseSheet met het materiaal met geringe wrijving (satijn) naar boven gericht op het midden van het bed (afbeeldingen). Zo nodig kan er een glijlaken op SatinSheet worden gelegd.

Alle SatinSheet-uitvoeringen zijn voorzien van een label met de aanduiding 'deze kant boven' zodat het product met de juiste zijde naar boven op het bed kan worden geplaatst.

Op alle SatinSheet-uitvoeringen/producten is een informatielabel genaaid, met aanwijzingen over het juiste gebruik van het product.

Plaats de SatinSheet 4Direction op de BaseSheet (satijn tegen satijn).

Strijk alle oneffenheden/plooien glad voordat u het glijsysteem onder de matras vastzet, om decubitus te voorkomen. De verzorgers trekken tegelijkertijd en diagonaal vanaf beide zijden.

Gebruik

Draaien met SatinSheet 4Direction (afbeelding 1-3)

Gebruik SatinSheet 4Direction altijd met een van de SatinSheet-modellen.

De achterzijde van SatinSheet 4Direction is gemaakt van materiaal met lage wrijving. Het is ideaal voor gebruik bij bariatrische patiënten. De procedure voor draaien met SatinSheet 4Direction is identiek aan die voor draaien met SatinSheet en een glijlaken.

Een gebruiker in bed draaien: Pak het glijlaken op heup- en schouderhoogte vast. Voor een optimale ergonomische greep moet de verzorger daarbij zo veel mogelijk stof vastpakken.

Werk altijd met gestrekte polsen en verplaatsing van het gewicht. Het draaien met SatinSheet kan ook worden uitgevoerd door twee verzorgers. De verzorgers werken samen. De ene verzorger trekt aan de SatinSheet, terwijl de andere verzorger de matras voorzichtig indrukt ter hoogte van de heupen en schouders van de gebruiker.

Bij gebruik van SatinSheet 4Direction met handvatten, kunt u de gebruiker met behulp van een tillift draaien. Haak de bandhandvatten op de haken van het tiljuk en draai de gebruiker op een langzaam tempo (afbeelding 4+5). Breng een positioneringskussen of -wig aan ter ondersteuning van de rug van de gebruiker en laat de tillift weer langzaam zakken. Maak de handvatten aan de haken van het tiljuk los. Zet indien vereist de beddekken omhoog.

Gebruiker draaien.

Het glijsysteem na het draaien vastzetten: vouw het overtollige materiaal van de DrawSheet aan beide zijden van het bed onder de matras.

De gebruiker hoger in het bed zetten (afbeelding 6)

Om de gebruiker hoger in het bed te plaatsen pakt u SatinSheet 4Direction aan weerszijden bij de schouders van de gebruiker vast. De verzorger staat met de ene voet naar voren en trekt door zijn/haar gewicht te verplaatsen.

Rechttop zitten in bed met SatinSheet 4Direction (afbeelding 7+8)

Om te voorkomen dat de gebruiker tijdens het rechttop zitten

omlaag glijdt, kan een deel van SatinSheet 4Direction onder de gebruiker worden gevouwen. Vouw SatinSheet vervolgens, uitsluitend bij de heupen, onder de matras. Het hoofdeinde van het bed kan vervolgens omhoog worden gezet. SatinSheet heeft hier een remmende werking.

In buikligging leggen

Verwijder het hoofdeinde van het bed. Is de gebruiker aangesloten op een beademingsapparaat of andere levensreddende apparatuur, draai dan de gebruiker richting die apparatuur. Leg de hand van de gebruiker onder zijn/haar heup. Leg zo nodig 2 à 3 hoofd-of steunkussens boven op het lichaam van de gebruiker. Leg een SatinSheet4Direction-laken over de kussens heen met de satijnen kant naar boven, te beginnen bij het hoofdeinde; vouw het 4Direction-laken vanaf het hoofd van de gebruiker. Leg het SatinSheet4Direction-laken als een cocon om de gebruiker heen.

Vouw het onderste 4Direction-laken bij het hoofd om (satijn op satijn) Eén zorgverlener houdt het hoofd van de gebruiker goed vast; aan elke kant van het bed staat één zorgverlener om het lichaam van de gebruiker te ondersteunen. Draai de gebruiker om naar de andere kant van het bed. Plaats de lussen van het SatinSheet4Direction-laken waarop de gebruiker ligt, in de haken van de slinghanger en draai de gebruiker langzaam bijna 90° graden (afbeelding 9). Duw en trek een beetje aan het SatinSheet4direction-laken, zodat de gebruiker iets uit het midden van het bed komt te liggen. Als de gebruiker op zijn/haar zij ligt, stopt één zorgverlener het SatinSheet4Direction-laken dat op het bed ligt onder de gebruiker om het weg te kunnen trekken als de gebruiker in buikligging is gedraaid. Dezelfde zorgverlener ondersteunt de gebruiker door zijn/haar handen op de schouder van de gebruiker te leggen. Ga verder met het draaien van de gebruiker, totdat hij/zij in buikligging ligt. Laat de tilvoorziening weer zakken. Haal de lussen uit de haken van de slinghanger om het SatinSheet4Direction-laken eraf te halen. Vouw het 4Direction-laken onder het hoofd van de gebruiker naar beneden. Verplaats de gebruiker zo nodig naar het midden van het bed. Zorg dat de gebruiker goed ligt (afbeelding 10). Zet zo nodig de bedrails omhoog. Draai de gebruiker op dezelfde manier in rugligging.

Let op

Speciale functies

Controleer het product voor elk gebruik en na het wassen.

Gebruik een product nooit als het defect is. Voer het product af als het tekenen van slijtage vertoont.

Lees deze instructies zorgvuldig door.

Het is belangrijk dat verzorgers instructies krijgen over handmatig tillen en verplaatsen. Etac biedt advies en training aan voor verzorgers. Neem voor meer informatie contact op met Etac.

Gebruik altijd de juiste technieken voor handmatig tillen en verplaatsen.

Moedig de gebruiker aan om waar mogelijk mee te helpen.

Bedenk altijd van tevoren hoe u een gebruiker handmatig gaat tillen en verplaatsen, zodat de gebruiker zich veilig voelt en elke handmatige handeling soepel verloopt.



Er bestaat een kans dat de gebruiker wegglijdt. Laat de gebruiker nooit alleen achter op de rand van het bed.



Laat het product nooit op de vloer liggen.



Voer altijd een risicoanalyse uit en verzeker u ervan dat het hulpmiddel geschikt is voor de individuele gebruiker en, bij gebruik in combinatie met andere hulpmiddelen, veilig is voor de gebruiker en de verzorgers.



Het wordt aangeraden om het bedhek omhoog te zetten als de gebruiker op het glijsysteem blijft liggen, tenzij uit de risicoanalyse is gebleken dat de gebruiker veilig op het glijsysteem kan blijven liggen zonder gebruik te maken van de bedhekken.



Zet het glijsysteem altijd vast nadat u de transfer hebt voltooid.

Neem bij twijfel contact op met Etac.

Materiaal en reiniging

Materiaal:

SatinSheet 4Direction:

Polykatoen: 55% katoen, 45% polyester.

Satijn: Polyester.

SatinSheet In2Sheet 4Direction:

Microvezel bovenzijde: Polyester

Binnenmateriaal: 65% polyester, 35% viscose

Barrière: Polyurethaan

Glijdeel: Polyester

Handvatten: Nylon

Vleugels: 55% katoen, 45% polyester.

Absorptie: 2200 ml/m².

Het product moet regelmatig worden gecontroleerd, bij voorkeur voor elk gebruik, en met name na het wassen.

Controleer op schade aan de naden en de stof.



**Probeer een product nooit zelf te repareren.
Gebruik een product nooit als het defect is.**



We adviseren om het product voor gebruik te wassen.

Wasinstructies:

Strijken verbetert het glijeffect.

Gebruik geen wasverzachter.

Dit product kan ook worden gereinigd met een reinigingsmiddel dat geen oplosmiddel bevat en een pH-waarde tussen 5 en 9 heeft. U kunt ook een ontsmettingsmiddel met een concentratie van 70% gebruiken.



Producten en accessoires

Artikelnr.	Productbeschrijving	Afmetingen (mm)
IM4115S	SatinSheet 4Direction - midi (satin W1470xL1400 mm)	W2000xL1400
IM4115SH	SatinSheet 4Direction w/handles - midi (satin W1470xL1400)	W2000xL1400
IM4121S	SatinSheet 4Direction - maxi (satin W1470xL2000 mm)	W2000xL2000
IM4121SH	SatinSheet 4Direction w/handles - maxi (satin W1470xL2000)	W2000xL2000
IM4131SH	SatinSheet 4Direction w/handles maxi - wide	W3000xL2000
IM4110S	In2Sheet 4Direction w/wings - mini	W850xL900
IM4110SH	In2Sheet 4Direction w/wings + handles - mini	W850xL900
IM4140S	In2Sheet 4Direction w/wings - midi	W1200xL1400
IM4140SH	In2Sheet 4Direction w/wings and handles - midi	W1200xL1400

Set

Artikel-Nr.	Beschrijving	SatinSheet 2Direction BaseSheet	SatinSheet DrawSheet and SatinSheet 4Direction
IM4200S	SatinSheet DrawSheet midi set	IM4113S SatinSheet 2Direction midi	IM4118S SatinSheet DrawSheet - midi
IM4201S	SatinSheet DrawSheet mini set	IM4108S SatinSheet 2Direction mini	IM4116S SatinSheet DrawSheet - mini
IM4202S	SatinSheet DrawSheet maxi midi set	IM4114S SatinSheet 2Direction maxi	IM4118S SatinSheet DrawSheet - midi
IM4203S	SatinSheet 4Direction Fit midi set	IM4112S SatinSheet 2Direction FIT	IM4115S SatinSheet 4Direction - midi
IM4204S	SatinSheet 4Direction midi set	IM4113S SatinSheet 2Direction midi	IM4115S SatinSheet 4Direction - midi
IM4205S	SatinSheet DrawSheet midi small set	IM4119S SatinSheet 2Direction midi small	IM4118S SatinSheet DrawSheet - midi
IM4207S	SatinSheet 4Direction midi small set	IM4119S SatinSheet 2Direction midi small	IM4115S SatinSheet 4Direction - midi
IM4208S	SatinSheet Corner DrawSheet midi set	IM4107S SatinSheet 2Direction w/elastic	IM4118S SatinSheet DrawSheet - midi
IM4209S	SatinSheet In2Sheet midi mini set	IM4119S SatinSheet 2Direction midi small	IM4110S In2Sheet 4Direction w/wings - mini
IM4210S	SatinSheet In2Sheet mini set	IM4108S SatinSheet 2Direction mini	IM4110S In2Sheet 4Direction w/wings - mini
IM4211S	SatinSheet Corner 4Direction midi set	IM4107S SatinSheet 2Direction w/elastic	IM4115S SatinSheet 4Direction - midi
IM4212S	SatinSheet Corner 4Direction maxi set	IM4107S SatinSheet 2Direction w/elastic	IM4121S SatinSheet 4Direction - maxi
IM4213S	SatinSheet 4Direction maxi set	IM4114S SatinSheet 2Direction maxi	IM4121S SatinSheet 4Direction - maxi
IM4214S	SatinSheet 4Direction maxi set - wide	IM4177S SatinSheet2direction maxi - wide	IM4121S SatinSheet 4Direction - maxi
IM4215S	SatinSheet 4Direction maxi set - double	IM4180S SatinSheet 2Direction maxi - double	IM4121S SatinSheet 4Direction - maxi
IM4216S	SatinSheet 4Direction midi set - wide	IM4176S SatinSheet2direction midi - wide	IM4115S SatinSheet 4Direction - midi
IM4217S	SatinSheet 4Direction midi set - double	IM4179S SatinSheet2direction midi - double	IM4115S SatinSheet 4Direction - midi
IM4218S	SatinSheet 4Direction maxi midi set	IM4114S SatinSheet 2Direction maxi	IM4115S SatinSheet 4Direction - midi
IM4219S	SatinSheet 4Direction maxi midi set - wide	IM4177S SatinSheet2direction maxi - wide	IM4115S SatinSheet 4Direction - midi
IM4220S	SatinSheet 4Direction maxi midi set -double	IM4180S SatinSheet 2Direction maxi - double	IM4115S SatinSheet 4Direction - midi
IM4221S	SatinSheet DrawSheet maxi midi set - wide	IM4177S SatinSheet2direction maxi - wide	IM4118S SatinSheet DrawSheet - midi
IM4222S	SatinSheet DrawSheet maxi midi set - double	IM4180S SatinSheet 2Direction maxi - double	IM4118S SatinSheet DrawSheet - midi
IM4223S	SatinSheet DrawSheet midi set - wide	IM4176S SatinSheet2direction midi - wide	IM4118S SatinSheet DrawSheet - midi
IM4224S	SatinSheet DrawSheet midi set - double	IM4179S SatinSheet2direction midi - double	IM4118S SatinSheet DrawSheet - midi
IM4225S	SatinSheet Corner 4Direction midi set - wide	IM4147S SatinSheet 2Direction w/elastic-wide	IM4115S SatinSheet 4Direction - midi
IM4226S	SatinSheet Corner 4Direction midi set - double	IM4137S SatinSheet 2Direction w/elastic-double	IM4115S SatinSheet 4Direction - midi
IM4227S	SatinSheet Corner DrawSheet midi set - wide	IM4147S SatinSheet 2Direction w/elastic - wide	IM4118S SatinSheet DrawSheet - midi
IM4228S	SatinSheet Corner DrawSheet midi set - double	IM4137S SatinSheet 2Direction w/elastic-double	IM4118S SatinSheet DrawSheet - midi
IM4229S	SatinSheet Corner 4Direction maxi set - wide	IM4147S SatinSheet 2Direction w/elastic - wide	IM4121S SatinSheet 4Direction - maxi
IM4230S	SatinSheet Corner 4Direction maxi set - double	IM4137S SatinSheet 2Direction w/elastic - double	IM4121S SatinSheet 4Direction - maxi
IM4231S	SatinSheet Corner 4Direction w/handle midi set	IM4107S SatinSheet 2Direction w/elastic	IM4115SH SatinSheet 4Direction w/handles- midi
IM4251S	SatinSheet 4Direction maxi midi set - small		

Combinaties

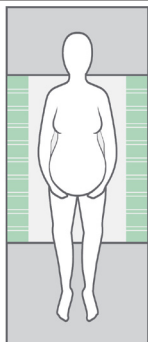

Article no. BaseSheet - Mini

IM4133S	SatinSheet 2Direction mini - small
IM4108S	SatinSheet 2Direction mini
IM4175S	SatinSheet 2Direction mini - wide
IM4178S	SatinSheet 2Direction mini - double

BaseSheet - Mini kan worden gecombineerd met:

Article no. DrawSheet, 4Direction and PillowCase

IM4116S	SatinSheet drawSheet - mini
IM4110S	In2Sheet 4Direction w/wings - mini
IM4110SH	In2Sheet 4Direction w/wings + handles - mini
IM4117S	SatinSheet 2Direction PillowCase

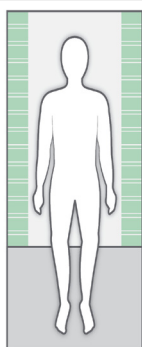

Article no. BaseSheet - Midi

IM4119S	SatinSheet 2Direction midi small
IM4113S	SatinSheet 2Direction midi
IM4176S	SatinSheet 2Direction midi - wide
IM4179S	SatinSheet 2Direction midi - double

BaseSheet - Midi kan worden gecombineerd met:

Article no. DrawSheet, 4Direction and PillowCase

IM4118S	SatinSheet DrawSheet - midi
IM4115S	SatinSheet 4Direction - midi
IM4115SH	SatinSheet 4Direction w/handles - midi
IM4121S	SatinSheet 4Direction - maxi
IM4121SH	SatinSheet 4Direction w/handles - maxi
IM4117S	SatinSheet 2Direction PillowCase

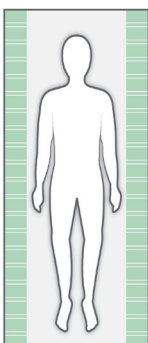

Article no. BaseSheet - Maxi

IM4181S	SatinSheet 2Direction maxi - small
IM4114S	SatinSheet 2Direction maxi
IM4177SH	SatinSheet 2Direction maxi - wide
IM4180S	SatinSheet 2Direction maxi - double
IM4122S	SatinSheet 2Direction 180cm bed

Article no. BaseSheet - Maxi Corner

IM4107S	SatinSheet 2Direction Corner
IM4147S	SatinSheet 2Direction Corner - wide
IM4137S	SatinSheet 2Direction Corner - double

Article no. BaseSheet - Maxi Fit

IM4112S	SatinSheet 2Direction Fit
IM4142S	SatinSheet 2Direction Elastic Fit

Article no. BaseSheet - Mini, Midi and Maxi Corner

IM4167S	SatinSheet 2Direction Corner - small - mini
IM4157S	SatinSheet 2Direction Corner - midi
IM4197S	SatinSheet 2Direction Corner - double - double - maxi

BaseSheet - Maxi/Corner/Fit kan worden gecombineerd met:

Article no. 4Direction and In2Sheet 4Direction

M4115S	SatinSheet 4Direction - midi
IM4115SH	SatinSheet 4Direction w/handles - midi
IM4140S	In2Sheet 4Direction w/wings - midi
IM4140SH	In2Sheet 4Direction - w/wings + handles - midi
IM4121S	SatinSheet 4Direction - maxi
IM4121SH	SatinSheet 4Direction w/handles - maxi

Denk ook aan een SatinSheet PillowCase (2D)

IM4117S	SatinSheet 2Direction PillowCase
---------	----------------------------------

Inspectie

Eerste inspectie:

- Is de verpakking onbeschadigd?
- Lees het label op de verpakking en controleer het artikelnummer en de productbeschrijving.
- Controleer of de beknopte handleiding is bijgevoegd. Nieuwe versies van de gebruikershandleiding/gebruiksaanwijzing kunt u downloaden via www.etac.com of opvragen bij de klantenservice van Etac of bij de distributeur in uw regio.
- Controleer of het label op het product de volgende informatie vermeldt: artikelnummer, productbeschrijving, partij-/batchnummer, reinigingsinstructies en naam van de leverancier.

Periodieke inspectie:

- Zorg dat uw systeem voor handmatige transfers altijd in perfecte staat verkeert.
- Controleer na het wassen altijd de materialen, het stikwerk, de handvatten en de gespen.
- Stel het product meteen buiten gebruik als het tekenen van slijtage vertoont.



Visuele inspectie/controleer het product:

Verzekert u ervan dat alle materialen, naden, stikwerk, handvatten en gespen onbeschadigd/vrij van defecten zijn.



Stabiliteitstest:

Probeer het product te verbuigen en verzeker u ervan dat het stevig, stabiel en solide aanvoelt.

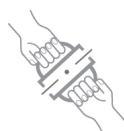

Mechanische belasting of spanning/handvatten testen:

Trek hard aan de handvatten in tegenovergestelde richtingen en controleer het materiaal, de naden en het stikwerk.



Hoge/lage wrijving testen:

Plaats het product op een stevige ondergrond of een bed, plaats uw handen op het materiaal en test de wrijving door uw handen in het product omlaag te drukken.

Lage wrijving: glijden gaat moeiteloos

Hoge wrijving: glijden/verplaatsen gaat niet

Gespen testen:

Zet de gesp vast en trek in tegenovergestelde richtingen; controleer de gesp en het stikwerk.

Controleren:

Handmatige transferhulpmiddelen met handvatten, banden en gespen



Handmatige transferhulpmiddelen voor zittende en liggende transfers met hoge of lage wrijving:



Productiejaar, -maand en -dag



Het product kan worden afgevoerd volgens de nationale voorschriften



Lees de gebruikershandleiding

Généralités

Nous vous remercions d'avoir choisi un produit Etac.

Veillez lire attentivement ce manuel afin d'éviter les accidents et les blessures lors du déplacement et de la manipulation des produits.

La personne décrite comme « l'utilisateur » dans ce manuel est la personne couchée ou assise sur le produit. Les assistants sont les personnes qui manœuvrent le produit.



Ce symbole apparaît à côté du texte dans le manuel. Il attire l'attention du lecteur sur les points pouvant constituer un risque pour la santé et la sécurité de l'utilisateur ou d'un assistant.

Les produits sont conformes aux normes applicables pour les produits de Classe 1 selon la réglementation relative aux dispositifs médicaux (EU) 2017/745 relative aux dispositifs médicaux.

Etac s'efforce constamment d'améliorer ses produits et se réserve donc le droit d'apporter des modifications à ses produits sans préavis. Toutes les mesures indiquées sur les illustrations et tout matériel similaire sont à titre indicatif seulement et Etac ne peut être tenu responsable des erreurs ou des défauts.

Les informations contenues dans ce manuel, y compris les

recommandations, combinaisons et tailles, ne s'appliquent pas aux commandes spéciales et aux modifications. Si le client effectue/utilise des réglages, des réparations ou des combinaisons qui ne sont pas prédéterminés par Etac, la certification CE d'Etac et la garantie d'Etac seront annulées. En cas de doute, veuillez contacter Etac.

Garantie : garantie de deux ans sur les matériaux et les défauts de fabrication, à condition que le produit soit utilisé correctement.

Durée de vie prévue : La durée de vie de cet appareil est d'un à deux ans dans des conditions normales d'utilisation. Sa durée de vie dépend de la fréquence d'utilisation, des charges ainsi que du nombre de lavage.

Pour de plus amples informations sur la gamme de transfert Etac, consultez www.etac.com.

En cas d'événement indésirable lié à l'appareil, signalez tout incident à votre revendeur local et aux autorités nationales compétentes dans les meilleurs délais. Le revendeur local transmettra les informations au fabricant.

Symboles en général

80°	Lavage	Niveau de pH / Essuyer	Avertissement	Fabricant
Ne pas javelliser	Ne jamais laisser sur le sol	Risque de glissement vers le bas	Jour, mois et année de fabrication YYYY-MM-DD	Marquage CE
Séchage en machine	Tenir à l'abri du soleil	Lire le manuel de l'utilisateur	Batch no./N° de lot	Garder au sec
Repassage	Poids max. de l'utilisateur = charge nominale maximale max 150 kg / max 330 lbs	Non stérile	Le produit peut être mis au rebut conformément à la réglementation nationale	Référence nationale
Ne pas nettoyer à sec				
MD	Dispositifs médicaux			

Usage prévu

SatinSheet 4Direction est un drap de tirage utilisé avec un drap de glissement (SatinSheet BaseSheet 2Direction). Le système SatinSheet est utilisé pour repositionner et tourner un patient alité.

Environnement prévu

Soins de courte durée, soins de longue durée, soins à domicile

Manipulation

Positionnement

Positionnez le drap SatinSheet BaseSheet avec le matériau à faibles frottements (satin) sur le haut dans le milieu du lit (Illustrations). Si nécessaire, un drap de tirage peut être posé sur SatinSheet.

Tous les modèles SatinSheet disposent d'une étiquette « ce côté vers le haut » indiquant quel côté du drap doit être orienté vers le haut dans le lit.

Une étiquette d'informations, décrivant l'utilisation correcte du produit, est cousue dans tous les modèles/produits SatinSheet.

Placez SatinSheet 4Direction sur le drap BaseSheet (le satin contre le satin).

Avant de verrouiller le système de glissement sous le matelas, il convient de lisser les plis/irrégularités pour éviter les cas de décubitus. Les soignants tirent simultanément et en diagonale des deux côtés.

Utilisation

Tourner avec SatinSheet 4Direction (Illustrations 1-3)

Utilisez toujours SatinSheet 4Direction avec l'un des modèles SatinSheet.

Le dos de SatinSheet 4Direction est fabriqué avec un matériau à faibles frottements. Il est idéal pour les utilisateurs bariatriques. La procédure pour tourner avec SatinSheet 4Direction est identique à la procédure pour tourner avec SatinSheet et un drap de tirage.

Pour tourner un utilisateur dans le lit : saisissez le drap de tirage au niveau des hanches et des épaules. Pour obtenir une meilleure saisie ergonomique, le soignant doit saisir autant de tissu que possible.

Travaillez toujours avec les poignets plats et servez-vous du transfert de poids.

Deux soignants peuvent également tourner avec SatinSheet. Les soignants travaillent ensemble. Un soignant tire sur SatinSheet tandis que l'autre tire le matelas vers le bas au niveau des hanches et des épaules de l'utilisateur, en poussant doucement.

En utilisant les poignées de SatinSheet 4Direction, vous pouvez tourner l'utilisateur avec un dispositif de levage. Accrochez les poignées au fléau du dispositif de levage, et tournez lentement l'utilisateur en levant (Illustrations 4+5). Placez une cale ou un coussin de positionnement dans le dos de l'utilisateur et baissez lentement le dispositif de levage de nouveau ; enlevez les poignées du fléau. Mettez en position haute les barrières de lit si nécessaire.

Tournez l'utilisateur.

Pour verrouiller le système de glissement après avoir tourné : pliez le tissu du drap DrawSheet en trop sous le matelas des deux côtés du lit.

Déplacer l'utilisateur plus haut dans le lit (Illustration 6)

Pour déplacer l'utilisateur plus haut dans le lit, saisissez le SatinSheet 4Direction des deux côtés des épaules de l'utilisateur. En se tenant debout avec un pied en avant, le soignant tire, en se servant du transfert de poids.

Se tenir assis dans le lit avec SatinSheet 4Direction (Illustrations 7+8)

Pour empêcher l'utilisateur de glisser vers le bas dans le lit

lorsqu'il s'assied, une partie de SatinSheet 4Direction peut être pliée sous l'utilisateur. Puis, pliez SatinSheet sous le matelas, mais seulement au niveau de la hanche. La tête de lit peut maintenant être élevée. Ici SatinSheet fonctionne comme un frein.

Position allongée ventrale

Retirez la tête de lit. Si le patient est relié à un respirateur ou à toute autre machine de réanimation, tournez-le vers l'équipement. Placez la main du patient sous sa hanche. Si nécessaire, placez 2-3 oreillers ou des coussins de positionnement sur le corps du patient. Placez une SatinSheet4Direction sur les oreillers, la face en satin sur le dessus, en commençant par la tête. Pliez-la ensuite pour dégager la tête du patient. Enveloppez ensuite le patient à l'aide de la SatinSheet4Direction, comme s'il était dans un cocon. Pliez la SatinSheet4Direction du dessous pour dégager la tête du patient (satin contre satin). Pendant qu'un soignant sécurise la tête du patient, deux autres soignants se placent chacun d'un côté du lit. Déplacez le patient du côté du lit auquel il tourne le dos. Accrochez les sangles de la SatinSheet4Direction sur laquelle le patient est installé au dispositif de suspension et pivotez lentement le patient d'environ 90° (Illustrations 9). Poussez le patient tout en tirant la SatinSheet4Direction, pour sécuriser la rotation et veiller à ce que le patient reste bien au centre. Lorsque le patient est sur le côté, tirez la SatinSheet4Direction sous le patient pour être en mesure de l'enlever lorsque le patient sera en position allongée ventrale. L'un des soignants soutient le patient en le maintenant par les épaules. Continuez à tourner le patient, jusqu'à ce qu'il soit en position allongée ventrale. Redescendez le lève-personne. Retirez les sangles des crochets du dispositif de suspension et retirez la SatinSheet4Direction. Dépliez la SatinSheet4Direction sous la tête du patient. Si besoin, déplacez le patient au centre du lit. Vérifiez que le patient est correctement positionné. (Illustration 10) Relevez les barrières du lit, si nécessaire. Pour mettre le patient en position allongée dorsale, procédez de la même manière.

Notice

Fonctions spéciales

Vérifiez toujours le produit avant toute utilisation et après tout lavage.

N'utilisez jamais un produit défectueux. Si le produit présente des signes d'usure, il doit être mis au rebut.

Lisez attentivement ces instructions.

Il est important que les soignants reçoivent une formation à la manipulation du produit. Etac propose des conseils et des formations à destination des soignants. Pour plus d'informations, contactez Etac.

Utilisez toujours de bonnes techniques de manipulation manuelle

Encouragez l'utilisateur à aider autant que possible.

Pour que l'utilisateur se sente en sécurité et que chaque manipulation manuelle se passe bien, planifiez toujours la manipulation à l'avance.



Il existe un risque de glissement de l'utilisateur. Ne laissez jamais l'utilisateur seul au bord du lit.



Ne laissez jamais le produit sur le sol.



Effectuez toujours une évaluation des risques et assurez-vous que le produit d'assistance convient à l'utilisateur et peut être utilisé en combinaison avec d'autres dispositifs d'une manière ne présentant aucun danger pour l'utilisateur et les soignants.



Il est recommandé que le rail de protection soit en place lorsque l'utilisateur est laissé sur le système de glissement, à moins qu'une évaluation des risques n'ait déterminé que l'utilisateur peut en toute sécurité être laissé sur le système de glissement sans que des rails de protection soient nécessaires.



Verrouillez toujours le système de glissement lorsque vous avez terminé le transfert.

En cas de doute - veuillez contacter Etac.

Matériau et nettoyage

Matériau :

SatinSheet 4Direction :
Polycoton : 55 % coton, 45 % polyester
Satin : Polyester.

SatinSheet In2Sheet 4Direction :
Côté supérieur en microfibre : Polyester
Couche du milieu : 65 % polyester, 35 % viscose
Barrière : Polyuréthane
Zone de glissement : Polyester
Poignées : Nylon
Ailles : 55 % coton, 45 % polyester.

Absorption: 2 200 ml/m².

Le produit doit être vérifié régulièrement, de préférence chaque fois qu'il est utilisé, et surtout après un lavage.

Vérifiez qu'il n'y a aucun dommage au niveau des coutures ou du tissu.



**N'essayez jamais de réparer un produit vous-même.
N'utilisez jamais un produit défectueux.**



Lavage du produit recommandé avant utilisation.

Instructions de lavage :

Repasser améliore l'effet de glisse.
N'utilisez pas d'adoucissant.

Le produit peut être nettoyé avec un agent nettoyant sans solvant, de pH compris entre 5 et 9, ou une solution désinfectante diluée à 70 %.



Produits et accessoires

N° d'article	Description	Dimensions (mm)
IM4115S	SatinSheet 4Direction - midi (satin W1470xL1400 mm)	W2000xL1400
IM4115SH	SatinSheet 4Direction w/handles - midi (satin W1470xL1400)	W2000xL1400
IM4121S	SatinSheet 4Direction - maxi (satin W1470xL2000 mm)	W2000xL2000
IM4121SH	SatinSheet 4Direction w/handles - maxi (satin W1470xL2000)	W2000xL2000
IM4131SH	SatinSheet 4Direction w/handles maxi - wide	W3000xL2000
IM4110S	In2Sheet 4Direction w/wings - mini	W850xL900
IM4110SH	In2Sweet 4Direction w/wings + handles - mini	W850xL900
IM4140S	In2Sheet 4Direction w/wings - midi	W1200xL1400
IM4140SH	In2Sheet 4Direction w/wings and handles - midi	W1200xL1400

Kit

N° d'article.	Description	SatinSheet 2Direction BaseSheet	SatinSheet DrawSheet and SatinSheet 4Direction
IM4200S	SatinSheet DrawSheet midi set	IM4113S SatinSheet 2Direction midi	IM4118S SatinSheet DrawSheet - midi
IM4201S	SatinSheet DrawSheet mini set	IM4108S SatinSheet 2Direction mini	IM4116S SatinSheet DrawSheet - mini
IM4202S	SatinSheet DrawSheet maxi midi set	IM4114S SatinSheet 2Direction maxi	IM4118S SatinSheet DrawSheet - midi
IM4203S	SatinSheet 4Direction Fit midi set	IM4112S SatinSheet 2Direction FIT	IM4115S SatinSheet 4Direction - midi
IM4204S	SatinSheet 4Direction midi set	IM4113S SatinSheet 2Direction midi	IM4115S SatinSheet 4Direction - midi
IM4205S	SatinSheet DrawSheet midi small set	IM4119S SatinSheet 2Direction midi small	IM4118S SatinSheet DrawSheet - midi
IM4207S	SatinSheet 4Direction midi small set	IM4119S SatinSheet 2Direction midi small	IM4115S SatinSheet 4Direction - midi
IM4208S	SatinSheet Corner DrawSheet midi set	IM4107S SatinSheet 2Direction w/elastic	IM4118S SatinSheet DrawSheet - midi
IM4209S	SatinSheet In2Sheet midi mini set	IM4119S SatinSheet 2Direction midi small	IM4110S In2Sheet 4Direction w/wings - mini
IM4210S	SatinSheet In2Sheet mini set	IM4108S SatinSheet 2Direction mini	IM4110S In2Sheet 4Direction w/wings - mini
IM4211S	SatinSheet Corner 4Direction midi set	IM4107S SatinSheet 2Direction w/elastic	IM4115S SatinSheet 4Direction - midi
IM4212S	SatinSheet Corner 4Direction maxi set	IM4107S SatinSheet 2Direction w/elastic	IM4121S SatinSheet 4Direction - maxi
IM4213S	SatinSheet 4Direction maxi set	IM4114S SatinSheet 2Direction maxi	IM4121S SatinSheet 4Direction - maxi
IM4214S	SatinSheet 4Direction maxi set - wide	IM4177S SatinSheet 2Direction maxi - wide	IM4121S SatinSheet 4Direction - maxi
IM4215S	SatinSheet 4Direction maxi set - double	IM4180S SatinSheet 2Direction maxi - double	IM4121S SatinSheet 4Direction - maxi
IM4216S	SatinSheet 4Direction midi set - wide	IM4176S SatinSheet 2Direction midi - wide	IM4115S SatinSheet 4Direction - midi
IM4217S	SatinSheet 4Direction midi set - double	IM4179S SatinSheet 2Direction midi - double	IM4115S SatinSheet 4Direction - midi
IM4218S	SatinSheet 4Direction maxi midi set	IM4114S SatinSheet 2Direction maxi	IM4115S SatinSheet 4Direction - midi
IM4219S	SatinSheet 4Direction maxi midi set - wide	IM4177S SatinSheet 2Direction maxi - wide	IM4115S SatinSheet 4Direction - midi
IM4220S	SatinSheet 4Direction maxi midi set - double	IM4180S SatinSheet 2Direction maxi - double	IM4115S SatinSheet 4Direction - midi
IM4221S	SatinSheet DrawSheet maxi midi set - wide	IM4177S SatinSheet 2Direction maxi - wide	IM4118S SatinSheet DrawSheet - midi
IM4222S	SatinSheet DrawSheet maxi midi set - double	IM4180S SatinSheet 2Direction maxi - double	IM4118S SatinSheet DrawSheet - midi
IM4223S	SatinSheet DrawSheet midi set - wide	IM4176S SatinSheet 2Direction midi - wide	IM4118S SatinSheet DrawSheet - midi
IM4224S	SatinSheet DrawSheet midi set - double	IM4179S SatinSheet 2Direction midi - double	IM4118S SatinSheet DrawSheet - midi
IM4225S	SatinSheet Corner 4Direction midi set - wide	IM4147S SatinSheet 2Direction w/elastic-wide	IM4115S SatinSheet 4Direction - midi
IM4226S	SatinSheet Corner 4Direction midi set - double	IM4137S SatinSheet 2Direction w/elastic-double	IM4115S SatinSheet 4Direction - midi
IM4227S	SatinSheet Corner DrawSheet midi set - wide	IM4147S SatinSheet 2Direction w/elastic - wide	IM4118S SatinSheet DrawSheet - midi
IM4228S	SatinSheet Corner DrawSheet midi set - double	IM4137S SatinSheet 2Direction w/elastic-double	IM4118S SatinSheet DrawSheet - midi
IM4229S	SatinSheet Corner 4Direction maxi set - wide	IM4147S SatinSheet 2Direction w/elastic - wide	IM4121S SatinSheet 4Direction - maxi
IM4230S	SatinSheet Corner 4Direction maxi set - double	IM4137S SatinSheet 2Direction w/elastic - double	IM4121S SatinSheet 4Direction - maxi
IM4231S	SatinSheet Corner 4Direction w/handle midi set	IM4107S SatinSheet 2Direction w/elastic	IM4115SH SatinSheet 4Direction w/handles - midi
IM4251S	SatinSheet 4Direction maxi midi set - small		

Combinaisons

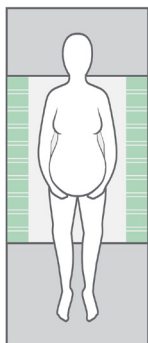

Article no.	BaseSheet - Mini
IM4133S	SatinSheet 2Direction mini - small
IM4108S	SatinSheet 2Direction mini
IM4175S	SatinSheet 2Direction mini - wide
IM4178S	SatinSheet 2Direction mini - double
BaseSheet - Mini peut être associé à :	
Article no.	DrawSheet, 4Direction and PillowCase
IM4116S	SatinSheet drawSheet - mini
IM4110S	In2Sheet 4Direction w/wings - mini
IM4110SH	In2Sheet 4Direction w/wings + handles - mini
IM4117S	SatinSheet 2Direction PillowCase

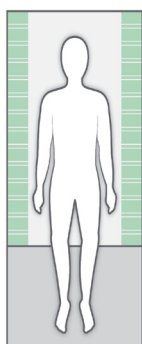

Article no.	BaseSheet - Midi
IM4119S	SatinSheet 2Direction midi small
IM4113S	SatinSheet 2Direction midi
IM4176S	SatinSheet 2Direction midi - wide
IM4179S	SatinSheet 2Direction midi - double
BaseSheet - Midi peut être associé à :	
Article no.	DrawSheet, 4Direction and PillowCase
IM4118S	SatinSheet DrawSheet - midi
IM4115S	SatinSheet 4Direction - midi
IM4115SH	SatinSheet 4Direction w/handles - midi
IM4121S	SatinSheet 4Direction - maxi
IM4121SH	SatinSheet 4Direction w/handles - maxi
IM4117S	SatinSheet 2Direction PillowCase

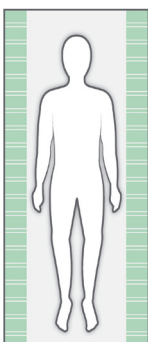

Article no.	BaseSheet - Maxi
IM4181S	SatinSheet 2Direction maxi - small
IM4114S	SatinSheet 2Direction maxi
IM4177SH	SatinSheet 2Direction maxi - wide
IM4180S	SatinSheet 2Direction maxi - double
IM4122S	SatinSheet 2Direction 180cm bed
Article no.	BaseSheet - Maxi Corner
IM4107S	SatinSheet 2Direction Corner
IM4147S	SatinSheet 2Direction Corner - wide
IM4137S	SatinSheet 2Direction Corner - double
Article no.	BaseSheet - Maxi Fit
IM4112S	SatinSheet 2Direction Fit
IM4142S	SatinSheet 2Direction Elastic Fit
Article no.	BaseSheet - Mini, Midi and Maxi Corner
IM4167S	SatinSheet 2Direction Corner - small -mini
IM4157S	SatinSheet 2Direction Corner - midi
IM4197S	SatinSheet 2Direction Corner - double - double - maxi
BaseSheet - Maxi/Corner/Fit peut être associé à :	
Article no.	4Direction and In2Sheet 4Direction
M4115S	SatinSheet 4Direction - midi
IM4115SH	SatinSheet 4Direction w/handles - midi
IM4140S	In2Sheet 4Direction w/wings - midi
IM4140SH	In2Sheet 4Direction - w/wings + handles - midi
IM4121S	SatinSheet 4Direction - maxi
IM4121SH	SatinSheet 4Direction w/handles - maxi
Souvenez-vous de SatinSheet PillowCase (2D)	
IM4117S	SatinSheet 2Direction PillowCase

Inspection

Première inspection :

- L'emballage est-il intact ?
- Lisez l'étiquette sur l'emballage et vérifiez le numéro d'article et la description du produit.
- Vérifiez que les instructions sommaires accompagnent le produit - vous pouvez télécharger un Manuel de l'utilisateur/Mode d'emploi mis à jour depuis le site www.etac.com ou l'obtenir en contactant le service client d'Etac ou le distributeur local.
- Vérifiez l'étiquette sur le produit - comporte-t-elle un n° d'article, une description du produit, un n° de lot/batch no, des instructions de nettoyage et le nom du fournisseur ?

Inspection périodique :

- Assurez-vous que votre système de transfert manuel est toujours en parfait état.
- Après un lavage - vérifiez toujours les matériaux, surpiqûres, poignées et boucles.
- Si le produit présente des signes d'usure, il doit être retiré du service immédiatement.



Inspection visuelle/Vérification du produit :

Veillez à ce que les matériaux, les coutures, les surpiqûres, les poignées et les boucles soient intacts/sans défaut.



Test de stabilité :

Essayez de plier le produit et vérifiez qu'il semble ferme, stable et solide.



Charge ou contrainte mécanique/

Test des poignées :

Tirez fortement les poignées dans des directions opposées et contrôlez les matériaux, les coutures et les surpiqûres.

Test des boucles :

Fermez la boucle et tirez dans des directions opposées. Contrôlez la boucle et les surpiqûres.



Test de friction basse/élevée :

Placez le produit sur une surface ferme ou un lit, placez vos mains sur le matériau et tester la friction en poussant avec les mains sur le produit.

Friction basse - vos mains glissent sans effort

Friction élevée - vos mains ne glissent pas/ ne bougent pas

Vérification::

Aides au transfert manuelles avec poignées, sangles et boucles



Aides au transfert manuelles pour positions assise et couchée avec friction basse ou élevée:

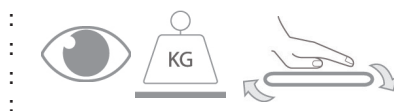

Jour, mois et année de fabrication



Le produit peut être mis au rebut conformément à la réglementation nationale.



Lire le manuel de l'utilisateur

Informazioni generali

Grazie per aver scelto un prodotto Etac.

Per evitare incidenti e lesioni durante lo spostamento e la movimentazione dei prodotti, leggere attentamente il manuale.

Nel presente manuale, il soggetto descritto come "l'utente" è la persona seduta o sdraiata sul prodotto. Gli assistenti sono coloro che manovrano il prodotto.



Questo simbolo è presente lungo le pagine del manuale. Richiama l'attenzione del lettore su punti che possono comportare rischi per la salute e la sicurezza dell'utente o dell'assistente.

I prodotti sono conformi alle norme applicabili per i prodotti di Classe 1 contenute nella regolamento sui dispositivi medici (EU) 2017/745 sui dispositivi medici.

In Etac ci sforziamo di migliorare continuamente i nostri prodotti; pertanto, ci riserviamo il diritto di modificare i prodotti senza preavviso. Tutte le misurazioni riportate nelle figure o in altro materiale informativo sono puramente indicative: Etac non può essere ritenuta responsabile di eventuali errori e difetti.

Le informazioni riportate nel presente manuale, ivi compresi

raccomandazioni, combinazioni e dati dimensionali, non sono applicabili a ordini e modifiche speciali. Qualora il cliente effettui regolazioni, riparazioni o combinazioni non autorizzate da Etac, la certificazione CE di Etac e la garanzia di Etac decadono. In caso di dubbi, contattare Etac.

Garanzia: garanzia di due anni per difetti di materiali e di fabbricazione, purché il prodotto sia stato utilizzato correttamente.

Durata prevista: La durata utile prevista del dispositivo, in normali condizioni d'uso, è compresa tra 1 e 2 anni. La durata utile del dispositivo varia in base alla frequenza d'uso, i carichi e la frequenza e modalità di lavaggio.

Per maggiori informazioni sulla gamma di dispositivi di trasferimento Etac, visitare il sito www.etac.com.

In caso di evento avverso verificatosi in relazione al dispositivo, gli incidenti devono essere segnalati tempestivamente al rivenditore locale e all'autorità nazionale competente. Il rivenditore locale inoltrerà le informazioni al produttore.

Panoramica dei simboli



Lavaggio



Livello di pH / Pulire con un panno



Attenzione



Produttore



Non candeggiare



Non lasciare sul pavimento



Giorno, mese e anno di produzione



Marchio CE



Asciugatura a tamburo a temperatura moderata



Rischio di scivolamento



N. di serie/lotto



Mantenere asciutto



Stiratura



Non esporre ai raggi solari



Limite massa utente = carico nominale massimo



Non sterile



Non lavare a secco



Leggere il manuale dell'utente



Smaltire il prodotto in conformità con le normative nazionali vigenti



Numero articolo



Dispositivo medico

Uso previsto

SatinSheet 4Direction è un dispositivo DrawSheet da utilizzare con BaseSheet (SatinSheet BaseSheet 2Direction). Il sistema SatinSheet è utilizzato per riposizionare e voltare un utente nel letto.

Ambiente previsto

Assistenza di pazienti gravi, assistenza a lungo termine, assistenza domiciliare

Movimentazione pratica

Posizionamento

Posizionare SatinSheet BaseSheet con il materiale a basso attrito (raso) rivolto verso l'alto al centro del letto (v. figure). Se necessario, è possibile collocare un telo sul SatinSheet. Tutti i modelli SatinSheet sono dotati di un'etichetta "Questo lato rivolto verso l'alto" che indica quale sia il lato corretto da rivolgere verso l'alto. Un'etichetta informativa che descrive l'uso corretto del prodotto è cucita su tutti i modelli/prodotti SatinSheet.

Posizionare SatinSheet 4Direction su BaseSheet (raso contro raso).

Prima di bloccare il sistema di movimentazione scorrevole sotto il materasso, lisciare eventuali stropicciamenti/grinze per evitare la formazione di piaghe da decubito. Gli assistenti tirano contemporaneamente e trasversalmente da entrambi i lati.

Uso

Girare il paziente con SatinSheet 4Direction (figg. 1, 3)

Utilizzare sempre SatinSheet 4Direction con uno dei modelli SatinSheet.

Il retro di SatinSheet 4Direction è in materiale a basso attrito. È ideale per l'uso con utenti bariatrici. La procedura per girare un utente con SatinSheet 4Direction è identica alla procedura per girare un paziente con SatinSheet e un telo. Per ruotare un utente nel letto afferrare il telo all'altezza dei fianchi e delle spalle. Per ottenere una presa ergonomica più salda, l'assistente dovrebbe afferrare quanto più tessuto possibile.

Lavorare sempre con i polsi piatti e spostando il peso. La rotazione con SatinSheet può essere eseguita anche da due assistenti che lavorano insieme. Un assistente aiuta a tirare SatinSheet, mentre l'altro preme sul materasso all'altezza dei fianchi e delle spalle dell'utente, spingendolo delicatamente.

Se si utilizza SatinSheet 4Direction con le impugnature è possibile ruotare l'utente con un sollevatore. Posizionare le impugnature della cinghia sui ganci della barra per imbracatura e ruotare lentamente l'utente (figg. 4, 5). Collocare un Positioning Wedge o cuscino di posizionamento per sostenere la schiena dell'utente e abbassare lentamente il sollevatore. Rimuovere le impugnature dai ganci della barra per imbracatura. Se necessario, alzare la barriera di protezione.

Girare l'utente.

Per bloccare il sistema di movimentazione scorrevole dopo aver girato l'utente: ripiegare il materiale in eccesso di DrawSheet sotto il materasso, su entrambi i lati del letto.

Solleverare l'utente più in alto nel letto (fig. 6)

Per sollevare l'utente più in alto nel letto, afferrare SatinSheet 4Direction su entrambi i lati all'altezza delle spalle dell'utente. Con un piede davanti all'altro, l'assistente tira spostando il proprio peso.

Portare l'utente in posizione seduta con SatinSheet 4Direction (figg. 7, 8)

Per impedire che l'utente scivoli nel letto dalla posizione seduta,

una parte di SatinSheet 4Direction può essere ripiegata sotto l'utente. Piegare quindi SatinSheet sotto al materasso, solo all'altezza dei fianchi. A questo punto è possibile sollevare la testata del letto. In questo caso SatinSheet funge da freno.

Posizionamento prono

Rimuovere la testiera del letto. Se l'utente è collegato a un ventilatore o ad altri macchinari salvavita, voltarlo in direzione dell'apparecchiatura. Posizionare la mano del paziente sotto il fianco. Se necessario, aggiungere 2 o 3 cuscini o cuscini di posizionamento sul corpo dell'utente. Stendere un SatinSheet4Direction sui cuscini con il lato in raso rivolto verso l'alto, piegare l'estremità di 4Direction allontanandola dalla testa dell'utente. Infilare il SatinSheet4Direction superiore sotto e attorno all'utente come per formare un bozzolo. Piegare il 4Direction inferiore allontanandolo dalla testa dell'utente (raso contro raso) Un assistente tiene ferma la testa dell'utente, mentre due assistenti sostengono l'utente da entrambi i lati. Spostare l'utente in direzione opposta a quella verso la quale viene voltato. Attaccare le impugnature della cinghia del SatinSheet4Direction su cui è sdraiato l'utente ai ganci della barra per imbracatura e voltare lentamente l'utente di quasi 90° (fig. 9) Spingere e tirare SatinSheet4direction per garantire la centralità della rotazione. Una volta che l'utente è sul fianco, un assistente infila il SatinSheet4Direction inferiore sotto l'utente per poterlo poi rimuovere quando l'utente verrà voltato in posizione prona. Lo stesso assistente sostiene l'utente tenendogli le mani sulla spalla. Continuare a fino al raggiungimento della posizione prona. Abbassare di nuovo il sollevatore. Staccare le impugnature dai ganci della barra per imbracatura e rimuovere SatinSheet4Direction. Stendere 4Direction sotto la testa dell'utente. Se necessario, spostare l'utente al centro del letto. Accertarsi che l'utente sia posizionato correttamente (fig. 10). Se necessario, sollevare le sponde del letto. La rotazione in posizione supina avviene nello stesso modo.

Avviso

Caratteristiche speciali

Controllare sempre il prodotto prima dell'uso e dopo il lavaggio.

Non utilizzare mai un prodotto difettoso. Smaltire il prodotto se questo presenta segni di usura.

Leggere attentamente le presenti istruzioni.

È importante che gli assistenti ricevano adeguate istruzioni sulla movimentazione manuale. Etac offre consulenza e formazione agli assistenti. Per maggiori informazioni, contattare Etac.

Utilizzare sempre le corrette tecniche di movimentazione manuale.

Se possibile, sollecitare l'utente a collaborare.

Per garantire che l'utente si senta sicuro e che ogni movimento sia fluido, pianificare sempre la movimentazione manuale in anticipo.



L'utente potrebbe scivolare. Non lasciare mai l'utente da solo sul bordo del letto.



Non lasciare mai il prodotto sul pavimento.



Eeguire sempre una valutazione dei rischi e accertarsi che il prodotto assistivo possa essere utilizzato per il singolo utente e che, in combinazione con altri dispositivi, sia sicuro per l'utente e gli assistenti.



Quando l'utente viene lasciato sul sistema di movimentazione scorrevole, è consigliabile installare la barriera di protezione, a meno che, in base a una valutazione dei rischi, non risulti possibile lasciare l'utente in sicurezza sul sistema senza barre di protezione.



A trasferimento ultimato, bloccare sempre il sistema di movimentazione scorrevole.

In caso di dubbi, contattare Etac.

Materiali e pulizia

Materiale:

SatinSheet 4Direction:

Policotone: 55% cotone, 45% poliestere.

Raso: Poliestere.

SatinSheet In2Sheet 4Direction:

Lato superiore in microfibra: Poliestere

Strato centrale: 65% poliestere, 35% viscosa

Barriera: Poliuretano

Area scorrevole: Poliestere

Impugnature: Nylon

Lembi: 55% cotone, 45% poliestere

Assorbimento: 2200 ml/m².

Controllare il prodotto regolarmente, preferibilmente ogni volta che viene utilizzato e in particolare dopo il lavaggio.

Controllare che non vi siano lacerazioni alle cuciture o al tessuto.



**Non tentare mai di riparare un prodotto da soli.
Non utilizzare mai un prodotto difettoso.**



Si consiglia di lavare il prodotto prima dell'uso.

Istruzioni di lavaggio:

La stiratura migliora l'effetto di scorrimento.

Non usare ammorbidente.

Lavare il prodotto utilizzando un detergente privo di solventi con pH compreso tra 5 e 9 oppure una soluzione disinfettante al 70%.



Prodotti e accessori

Articolo n.	Descrizione prodotto	Dimensioni (mm)
IM4115S	SatinSheet 4Direction - midi (satin W1470xL1400 mm)	W2000xL1400
IM4115SH	SatinSheet 4Direction w/handles - midi (satin W1470xL1400)	W2000xL1400
IM4121S	SatinSheet 4Direction - maxi (satin W1470xL2000 mm)	W2000xL2000
IM4121SH	SatinSheet 4Direction w/handles - maxi (satin W1470xL2000)	W2000xL2000
IM4131SH	SatinSheet 4Direction w/handles maxi - wide	W3000xL2000
IM4110S	In2Sheet 4Direction w/wings - mini	W850xL900
IM4110SH	In2Sweet 4Direction w/wings + handles - mini	W850xL900
IM4140S	In2Sheet 4Direction w/wings - midi	W1200xL1400
IM4140SH	In2Sheet 4Direction w/wings and handles - midi	W1200xL1400

Set

Articolo n.	Descrizione	SatinSheet 2Direction BaseSheet	SatinSheet DrawSheet and SatinSheet 4Direction
IM4200S	SatinSheet DrawSheet midi set	IM4113S SatinSheet 2Direction midi	IM4118S SatinSheet DrawSheet - midi
IM4201S	SatinSheet DrawSheet mini set	IM4108S SatinSheet 2Direction mini	IM4116S SatinSheet DrawSheet - mini
IM4202S	SatinSheet DrawSheet maxi midi set	IM4114S SatinSheet 2Direction maxi	IM4118S SatinSheet DrawSheet - midi
IM4203S	SatinSheet 4Direction Fit midi set	IM4112S SatinSheet 2Direction FIT	IM4115S SatinSheet 4Direction - midi
IM4204S	SatinSheet 4Direction midi set	IM4113S SatinSheet 2Direction midi	IM4115S SatinSheet 4Direction - midi
IM4205S	SatinSheet DrawSheet midi small set	IM4119S SatinSheet 2Direction midi small	IM4118S SatinSheet DrawSheet - midi
IM4207S	SatinSheet 4Direction midi small set	IM4119S SatinSheet 2Direction midi small	IM4115S SatinSheet 4Direction - midi
IM4208S	SatinSheet Corner DrawSheet midi set	IM4107S SatinSheet 2Direction w/elastic	IM4118S SatinSheet DrawSheet - midi
IM4209S	SatinSheet In2Sheet midi mini set	IM4119S SatinSheet 2Direction midi small	IM4110S In2Sheet 4Direction w/wings - mini
IM4210S	SatinSheet In2Sheet mini set	IM4108S SatinSheet 2Direction mini	IM4110S In2Sheet 4Direction w/wings - mini
IM4211S	SatinSheet Corner 4Direction midi set	IM4107S SatinSheet 2Direction w/elastic	IM4115S SatinSheet 4Direction - midi
IM4212S	SatinSheet Corner 4Direction maxi set	IM4107S SatinSheet 2Direction w/elastic	IM4121S SatinSheet 4Direction - maxi
IM4213S	SatinSheet 4Direction maxi set	IM4114S SatinSheet 2Direction maxi	IM4121S SatinSheet 4Direction - maxi
IM4214S	SatinSheet 4Direction maxi set - wide	IM4177S SatinSheet2direction maxi - wide	IM4121S SatinSheet 4Direction - maxi
IM4215S	SatinSheet 4Direction maxi set - double	IM4180S SatinSheet 2Direction maxi - double	IM4121S SatinSheet 4Direction - maxi
IM4216S	SatinSheet 4Direction midi set - wide	IM4176S SatinSheet2direction midi - wide	IM4115S SatinSheet 4Direction - midi
IM4217S	SatinSheet 4Direction midi set - double	IM4179S SatinSheet2direction midi - double	IM4115S SatinSheet 4Direction - midi
IM4218S	SatinSheet 4Direction maxi midi set	IM4114S SatinSheet 2Direction maxi	IM4115S SatinSheet 4Direction - midi
IM4219S	SatinSheet 4Direction maxi midi set - wide	IM4177S SatinSheet2direction maxi - wide	IM4115S SatinSheet 4Direction - midi
IM4220S	SatinSheet 4Direction maxi midi set - double	IM4180S SatinSheet 2Direction maxi - double	IM4115S SatinSheet 4Direction - midi
IM4221S	SatinSheet DrawSheet maxi midi set - wide	IM4177S SatinSheet2direction maxi - wide	IM4118S SatinSheet DrawSheet - midi
IM4222S	SatinSheet DrawSheet maxi midi set - double	IM4180S SatinSheet 2Direction maxi - double	IM4118S SatinSheet DrawSheet - midi
IM4223S	SatinSheet DrawSheet midi set - wide	IM4176S SatinSheet2direction midi - wide	IM4118S SatinSheet DrawSheet - midi
IM4224S	SatinSheet DrawSheet midi set - double	IM4179S SatinSheet2direction midi - double	IM4118S SatinSheet DrawSheet - midi
IM4225S	SatinSheet Corner 4Direction midi set - wide	IM4147S SatinSheet 2Direction w/elastic-wide	IM4115S SatinSheet 4Direction - midi
IM4226S	SatinSheet Corner 4Direction midi set - double	IM4137S SatinSheet 2Direction w/elastic-double	IM4115S SatinSheet 4Direction - midi
IM4227S	SatinSheet Corner DrawSheet midi set - wide	IM4147S SatinSheet 2Direction w/elastic - wide	IM4118S SatinSheet DrawSheet - midi
IM4228S	SatinSheet Corner DrawSheet midi set - double	IM4137S SatinSheet 2Direction w/elastic-double	IM4118S SatinSheet DrawSheet - midi
IM4229S	SatinSheet Corner 4Direction maxi set - wide	IM4147S SatinSheet 2Direction w/elastic - wide	IM4121S SatinSheet 4Direction - maxi
IM4230S	SatinSheet Corner 4Direction maxi set - double	IM4137S SatinSheet 2Direction w/elastic - double	IM4121S SatinSheet 4Direction - maxi
IM4231S	SatinSheet Corner 4Direction w/handle midi set	IM4107S SatinSheet 2Direction w/elastic	IM4115SH SatinSheet 4Direction w/handles - midi
IM4251S	SatinSheet 4Direction maxi midi set - small		

Combinazioni

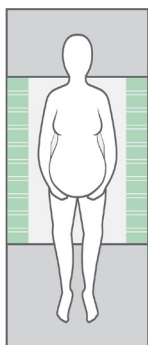

Article no.	BaseSheet - Mini
IM4133S	SatinSheet 2Direction mini - small
IM4108S	SatinSheet 2Direction mini
IM4175S	SatinSheet 2Direction mini - wide
IM4178S	SatinSheet 2Direction mini - double
BaseSheet - Mini può essere combinato con:	
Article no.	DrawSheet, 4Direction and PillowCase
IM4116S	SatinSheet drawSheet - mini
IM4110S	In2Sheet 4Direction w/wings - mini
IM4110SH	In2Sheet 4Direction w/wings + handles - mini
IM4117S	SatinSheet 2Direction PillowCase

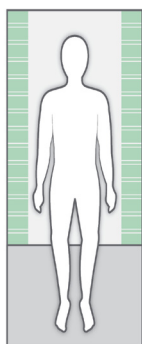

Article no.	BaseSheet - Midi
IM4119S	SatinSheet 2Direction midi small
IM4113S	SatinSheet 2Direction midi
IM4176S	SatinSheet 2Direction midi - wide
IM4179S	SatinSheet 2Direction midi - double
BaseSheet - Midi può essere combinato con:	
Article no.	DrawSheet, 4Direction and PillowCase
IM4118S	SatinSheet DrawSheet - midi
IM4115S	SatinSheet 4Direction - midi
IM4115SH	SatinSheet 4Direction w/handles - midi
IM4121S	SatinSheet 4Direction - maxi
IM4121SH	SatinSheet 4Direction w/handles - maxi
IM4117S	SatinSheet 2Direction PillowCase

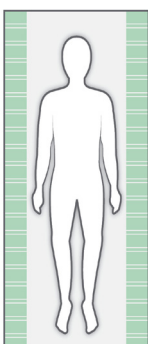

Article no.	BaseSheet - Maxi
IM4181S	SatinSheet 2Direction maxi - small
IM4114S	SatinSheet 2Direction maxi
IM4177SH	SatinSheet 2Direction maxi - wide
IM4180S	SatinSheet 2Direction maxi - double
IM4122S	SatinSheet 2Direction 180cm bed
Article no.	BaseSheet - Maxi Corner
IM4107S	SatinSheet 2Direction Corner
IM4147S	SatinSheet 2Direction Corner - wide
IM4137S	SatinSheet 2Direction Corner - double
Article no.	BaseSheet - Maxi Fit
IM4112S	SatinSheet 2Direction Fit
IM4142S	SatinSheet 2Direction Elastic Fit
Article no.	BaseSheet - Mini, Midi and Maxi Corner
IM4167S	SatinSheet 2Direction Corner - small -mini
IM4157S	SatinSheet 2Direction Corner - midi
IM4197S	SatinSheet 2Direction Corner - double - double - maxi
BaseSheet - Maxi/Corner/Fit può essere combinato con:	
Article no.	4Direction and In2Sheet 4Direction
M4115S	SatinSheet 4Direction - midi
IM4115SH	SatinSheet 4Direction w/handles - midi
IM4140S	In2Sheet 4Direction w/wings - midi
IM4140SH	In2Sheet 4Direction - w/wings + handles - midi
IM4121S	SatinSheet 4Direction - maxi
IM4121SH	SatinSheet 4Direction w/handles - maxi
Ricordarsi di utilizzare SatinSheet PillowCase (2D)	
IM4117S	SatinSheet 2Direction PillowCase

Ispezione

Prima ispezione:

- La confezione è intatta?
- Leggere l'etichetta sulla confezione e controllare il numero dell'articolo e la descrizione del prodotto.
- Verificare che il foglio di istruzioni sia presente nella confezione. È possibile scaricare la versione aggiornata del manuale dell'utente/delle istruzioni per l'uso dal sito www.etac.com oppure contattare il servizio clienti Etac o il proprio rivenditore locale.
- Controllare l'etichetta sul prodotto: riporta il numero dell'articolo, la descrizione del prodotto, il numero di serie/lotto, le istruzioni per la pulizia e il nome del fornitore?

Ispezione periodica:

- Assicurarsi che il sistema di trasferimento manuale sia sempre in perfette condizioni.
- Dopo il lavaggio, verificare sempre lo stato di materiali, cuciture, impugnature e fibbie.
- Se il prodotto presenta segni di usura, dismetterlo immediatamente.



Ispezione visiva/controllo del prodotto:

Assicurarsi che i materiali, le cuciture, le impugnature, le impugnature e le fibbie siano intatti/privi di difetti.



Test di stabilità:

Provare a piegare il prodotto e verificare che sia robusto, stabile e resistente.



Carico o sollecitazioni di tipo meccanico/ Test sulle impugnature:

Tirare con forza le impugnature in direzioni opposte; quindi, controllare il materiale, le cuciture e le impunture.

Test sulle fibbie:

Bloccare la fibbia e tirare in direzioni opposte; quindi, controllare la fibbia e le cuciture.



Test di attrito basso/elevato:

Posizionare il dispositivo su una superficie resistente o un letto, poggiare le mani sul materiale e testarne l'attrito spingendo sul prodotto.

Attrito basso: scorre senza sforzo

Attrito elevato: non scorre/non si muove

Controlli da effettuare:

Ausili per il trasferimento manuale con impugnature, cinghie e fibbie:



Ausili per il trasferimento manuale di utenti seduti e sdraiati con attrito basso o elevato:

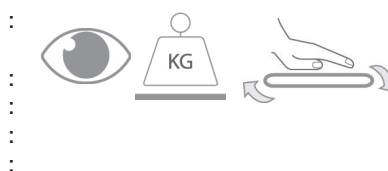

Giorno, mese e anno di produzione



Smaltire il prodotto in conformità con le normative nazionali vigenti



Leggere il manuale dell'utente

Información general

Gracias por elegir un producto Etac.

Para evitar cualquier tipo de accidente o lesión cuando mueva y maneje los productos, lea atentamente el manual.

La persona descrita como el «usuario» se referirá, en estas Instrucciones de uso, a la persona que está tumbada o sentada sobre el producto. Los cuidadores son las personas que manipulan el producto.



Este símbolo aparecerá al lado del texto en el manual. Le indica al lector aquellos puntos en los que puede existir un riesgo para la salud y la seguridad del usuario o del cuidador.

Los productos cumplen con la normativa aplicable para productos de la Clase 1, de la Regulación de productos sanitarios (EU) 2017/745, relativa a los dispositivos médicos.

En Etac, hacemos todo lo posible por mejorar constantemente nuestros productos y, por ese motivo, nos reservamos el derecho a modificar los productos sin previo aviso. Las medidas que se indican en las imágenes y en material similar se incluyen solo a modo de guía y Etac queda exenta de cualquier tipo de responsabilidad por errores y defectos.

La información incluida en este manual, incluidas las

recomendaciones, las combinaciones y los tamaños, no resulta de aplicación para los pedidos especiales ni para las modificaciones. Si el cliente efectúa ajustes, reparaciones o combinaciones que no están previstas por Etac, la certificación Etac CE y la garantía de Etac serán nulas de pleno derecho. En caso de duda, póngase en contacto con Etac.

Garantía: garantía de dos años por defectos del material y de fabricación, siempre y cuando el producto se haya utilizado correctamente.

Vida útil prevista: El producto tiene una vida útil prevista de 1 a 2 años en condiciones de uso normales. La vida útil del producto dependerá de la frecuencia de uso, de las cargas y de la frecuencia con la que se lave.

Para más información sobre la gama de productos de movilización de usuarios de Etac, consulte www.etac.com.

En caso de que se produzca un acontecimiento adverso en relación con el dispositivo, deberá informar de la incidencia, a su debido tiempo, a su distribuidor local y a la autoridad competente nacional. El distribuidor local enviará la información al fabricante.

Símbolos generales



Lavado



Nivel pH / Pasar un paño



Cuidado



Fabricante



No utilizar lejía



No dejar nunca en el suelo



Año, mes y día de producción



Marcado CE



Secar en secadora



Riesgo de resbalar



N.º de lote



Mantener seco



Planchar



Manténgase alejado de la luz del sol



Peso máximo del usuario = carga nominal máxima



No estéril



No limpiar en seco



Leer el manual de usuario



El producto se puede desechar de conformidad con la normativa nacional



Número de artículo



Producto sanitario

Uso previsto

SatinSheet 4Direction es una sábana DrawSheet para su uso con una sábana BaseSheet (SatinSheet BaseSheet 2Direction). El sistema SatinSheet se utiliza para reposicionar y girar a un usuario en una cama.

Entorno de uso previsto

Cuidados intensivos, cuidados de larga duración, cuidados domiciliarios.

Modo de uso

Colocación

Coloque SatinSheet BaseSheet con el material de baja fricción (raso) de la parte superior en el centro de la cama (vea las imágenes). De ser preciso, se puede colocar una sábana de arrastre sobre SatinSheet.

Todos los modelos de SatinSheet tienen una etiqueta con la inscripción «this side up» (este lado hacia arriba) que le indica qué lado de la sábana debería estar colocado hacia arriba sobre la cama.

Todos los modelos/productos SatinSheet tienen cosida una etiqueta informativa en la que se describe el uso correcto del producto.

Coloque SatinSheet 4Direction sobre BaseSheet (raso contra raso).

Antes de fijar el sistema deslizante debajo del colchón, deberá alisar cualquier irregularidad/arrugas para evitar que el usuario se coloque en decúbito. Los cuidadores tirarán a la vez y en diagonal de ambos lados.

Uso

Girar al usuario con SatinSheet 4Direction (imágenes 1-3)

Utilice siempre SatinSheet 4Direction con uno de los modelos de SatinSheet.

La parte trasera de SatinSheet 4Direction está fabricada de material de baja fricción. Resulta ideal para su uso con usuarios bariátricos. El procedimiento para girar al usuario con SatinSheet 4Direction es el mismo que el que se sigue con SatinSheet y una sábana de arrastre.

Para girar a un usuario en la cama: agarre la sábana de arrastre a la altura de las caderas y los hombros. Con el fin de obtener un agarre más ergonómico, el cuidador debería agarrar la mayor cantidad de tela posible.

Trabaje siempre con las muñecas planas y el traslado del peso. También es posible girar a un usuario con SatinSheet con la participación de dos cuidadores. Los cuidadores trabajan juntos. Uno de los cuidadores ayuda a tirar de SatinSheet mientras el otro la coloca sobre el colchón a la altura de las caderas y los hombros del usuario, presionando suavemente.

El uso de SatinSheet 4Direction con asas permite girar al usuario con una grúa. Coloque las asas en la percha de la grúa y gire lentamente al usuario (imágenes 4+5). Coloque un cojín de posicionamiento o cuña para apoyar la espalda del usuario y baje la grúa lentamente otra vez. Quite las asas de la percha. Suba las barandillas protectoras si es preciso.

Gire al usuario.

Para fijar el sistema deslizante después de girarlo: pliegue el material que sobre de la sábana DrawSheet debajo del colchón por ambos lados de la cama.

Mover al usuario más arriba en la cama (imagen 6)

Para subir al usuario en la cama, agarre SatinSheet 4Direction por ambos lados de los hombros del usuario. Colocado con un pie adelantado, el cuidador tira, mediante el traslado del peso.

Sentar al usuario en la cama con SatinSheet 4Direction (imágenes 7+8)

Para evitar que el usuario se deslice hacia abajo en la cama

cuando esté sentado, se puede plegar parte de SatinSheet 4Direction debajo del usuario. A continuación, pliegue SatinSheet debajo del colchón, aunque solo a la altura de la cadera. Entonces podrá elevar el cabecero de la cama. SatinSheet funciona aquí a modo de freno.

Decúbito prono

Retire el cabecero de la cama. Si el usuario está conectado a un respirador u otras máquinas para mejorar la calidad de vida, gire al usuario hacia el equipo. Coloque la mano del usuario debajo de la cadera. Si es necesario, coloque 2 o 3 almohadas o cojines de colocación por encima del cuerpo del usuario. Coloque un SatinSheet4Direction en las almohadas con el satén orientado hacia arriba, comenzando en el extremo de la cabeza (doble el 4Direction alejándolo de la cabeza del usuario). Estire la parte del usuario como si lo envolviese. Doble la parte inferior del 4Direction alejándola de la cabeza del usuario (satén contra satén). Un cuidador deberá asegurar la cabeza del usuario y dos cuidadores deberán colocarse a cada lado para proporcionar apoyo al usuario. Mueva al usuario al lado opuesto en el que esté colocado. Coloque los tiradores de correas del SatinSheet4Direction en la que esté tumbado el usuario en los ganchos de la barra de cabestrillo y gire lentamente al usuario a casi 90° (Ilustraciones 9) Empuje y tire del SatinSheet4direction para asegurarse de que la rotación no esté centrada. Cuando el usuario esté de lado, un cuidador tirará del SatinSheet4Direction colocado en la cama por debajo del usuario para poder retirarlo cuando se coloque al usuario boca abajo. El mismo cuidador ayudará al usuario colocando sus manos en su hombro. Continúe girando al usuario hasta que esté en decúbito prono. Vuelva a bajar el elevador. Retire los tiradores de los ganchos de la barra de cabestrillo y quite el SatinSheet4Direction. Despliegue el 4Direction bajo la cabeza del usuario. Si fuera necesario, coloque al usuario en el centro de la cama. Asegúrese de que el usuario esté correctamente colocado. (imagen 10) Levante los rieles de la cama si es necesario. Coloque al usuario en decúbito supino de la misma manera.

Aviso

Características especiales

Verifique siempre el producto antes de usarlo y después de lavarlo.

No utilice nunca un producto defectuoso. Si el producto presenta signos de desgaste o rotura, debe desecharse.

Lea estas instrucciones cuidadosamente.

Es importante que los cuidadores reciban formación para la movilización manual. Etac ofrece información y formación para cuidadores. Para más información, póngase en contacto con Etac.

Utilice siempre las técnicas de movilización manual correctas.

Anime al usuario a ayudar cuando le resulte posible.

Para asegurarse de que el usuario se siente seguro y que cada movilización manual se hace de manera suave, planifique siempre con antelación la movilización manual.



Existe un riesgo de que el usuario se resbale. No deje nunca al usuario solo en el borde de la cama.



No deje nunca el producto en el suelo.



Lleve a cabo siempre una evaluación de los riesgos, y asegúrese de que el producto asistencial puede utilizarse con el usuario concreto y combinado con otros dispositivos que sean seguros tanto para el usuario como para los cuidadores.



Se recomienda dejar puesta la barandilla protectora cuando se deje al usuario sobre el sistema deslizante, a menos que, después de evaluar los riesgos, se haya determinado que se puede dejar al usuario con total seguridad en él sin necesidad de barandillas.



Fije siempre el sistema deslizante cuando haya terminado la movilización.

En caso de cualquier duda, póngase en contacto con Etac.

Material y limpieza

Material:

SatinSheet 4Direction:

Polialgodón: 55 % algodón, 45 % poliéster

Raso: Poliéster.

SatinSheet In2Sheet 4Direction:

Parte superior de microfibra: Poliéster

Capa intermedia: 65 % poliéster, 35 % viscosa

Barrera: Poliuretano

Área deslizante: Poliéster

Asas: Nailon

Alas: 55 % algodón, 45 % poliéster.

Absorción: 2200 ml/m².

El producto debería revisarse con regularidad, preferentemente cada vez que se use y sobre todo después de haberlo lavado.

Compruebe que las costuras o el tejido no estén dañados.



**No intente reparar usted mismo el producto.
No utilice nunca un producto defectuoso.**



Se recomienda lavar el producto antes de usarlo.

Instrucciones de lavado:

El planchado mejora el efecto deslizante.

No utilizar suavizante.

El producto se puede limpiar con un agente limpiador sin disolventes con un nivel de pH entre 5-9, o una solución de desinfección al 70 %.



Productos y accesorios

Nº del artículo	Descripción del producto	Tamaño (mm)
IM4115S	SatinSheet 4Direction - midi (satin W1470xL1400 mm)	W2000xL1400
IM4115SH	SatinSheet 4Direction w/handles - midi (satin W1470xL1400)	W2000xL1400
IM4121S	SatinSheet 4Direction - maxi (satin W1470xL2000 mm)	W2000xL2000
IM4121SH	SatinSheet 4Direction w/handles - maxi (satin W1470xL2000)	W2000xL2000
IM4131SH	SatinSheet 4Direction w/handles maxi - wide	W3000xL2000
IM4110S	In2Sheet 4Direction w/wings - mini	W850xL900
IM4110SH	In2Sweet 4Direction w/wings + handles - mini	W850xL900
IM4140S	In2Sheet 4Direction w/wings - midi	W1200xL1400
IM4140SH	In2Sheet 4Direction w/wings and handles - midi	W1200xL1400

Set

Nº del artículo.	Descripción	SatinSheet 2Direction BaseSheet	SatinSheet DrawSheet and SatinSheet 4Direction
IM4200S	SatinSheet DrawSheet midi set	IM4113S SatinSheet 2Direction midi	IM4118S SatinSheet DrawSheet - midi
IM4201S	SatinSheet DrawSheet mini set	IM4108S SatinSheet 2Direction mini	IM4116S SatinSheet DrawSheet - mini
IM4202S	SatinSheet DrawSheet maxi midi set	IM4114S SatinSheet 2Direction maxi	IM4118S SatinSheet DrawSheet - midi
IM4203S	SatinSheet 4Direction Fit midi set	IM4112S SatinSheet 2Direction FIT	IM4115S SatinSheet 4Direction - midi
IM4204S	SatinSheet 4Direction midi set	IM4113S SatinSheet 2Direction midi	IM4115S SatinSheet 4Direction - midi
IM4205S	SatinSheet DrawSheet midi small set	IM4119S SatinSheet 2Direction midi small	IM4118S SatinSheet DrawSheet - midi
IM4207S	SatinSheet 4Direction midi small set	IM4119S SatinSheet 2Direction midi small	IM4115S SatinSheet 4Direction - midi
IM4208S	SatinSheet Corner DrawSheet midi set	IM4107S SatinSheet 2Direction w/elastic	IM4118S SatinSheet DrawSheet - midi
IM4209S	SatinSheet In2Sheet midi mini set	IM4119S SatinSheet 2Direction midi small	IM4110S In2Sheet 4Direction w/wings - mini
IM4210S	SatinSheet In2Sheet mini set	IM4108S SatinSheet 2Direction mini	IM4110S In2Sheet 4Direction w/wings - mini
IM4211S	SatinSheet Corner 4Direction midi set	IM4107S SatinSheet 2Direction w/elastic	IM4115S SatinSheet 4Direction - midi
IM4212S	SatinSheet Corner 4Direction maxi set	IM4107S SatinSheet 2Direction w/elastic	IM4121S SatinSheet 4Direction - maxi
IM4213S	SatinSheet 4Direction maxi set	IM4114S SatinSheet 2Direction maxi	IM4121S SatinSheet 4Direction - maxi
IM4214S	SatinSheet 4Direction maxi set - wide	IM4177S SatinSheet2direction maxi - wide	IM4121S SatinSheet 4Direction - maxi
IM4215S	SatinSheet 4Direction maxi set - double	IM4180S SatinSheet 2Direction maxi - double	IM4121S SatinSheet 4Direction - maxi
IM4216S	SatinSheet 4Direction midi set - wide	IM4176S SatinSheet2direction midi - wide	IM4115S SatinSheet 4Direction - midi
IM4217S	SatinSheet 4Direction midi set - double	IM4179S SatinSheet2direction midi - double	IM4115S SatinSheet 4Direction - midi
IM4218S	SatinSheet 4Direction maxi midi set	IM4114S SatinSheet 2Direction maxi	IM4115S SatinSheet 4Direction - midi
IM4219S	SatinSheet 4Direction maxi midi set - wide	IM4177S SatinSheet2direction maxi - wide	IM4115S SatinSheet 4Direction - midi
IM4220S	SatinSheet 4Direction maxi midi set - double	IM4180S SatinSheet 2Direction maxi - double	IM4115S SatinSheet 4Direction - midi
IM4221S	SatinSheet DrawSheet maxi midi set - wide	IM4177S SatinSheet2direction maxi - wide	IM4118S SatinSheet DrawSheet - midi
IM4222S	SatinSheet DrawSheet maxi midi set - double	IM4180S SatinSheet 2Direction maxi - double	IM4118S SatinSheet DrawSheet - midi
IM4223S	SatinSheet DrawSheet midi set - wide	IM4176S SatinSheet2direction midi - wide	IM4118S SatinSheet DrawSheet - midi
IM4224S	SatinSheet DrawSheet midi set - double	IM4179S SatinSheet2direction midi - double	IM4118S SatinSheet DrawSheet - midi
IM4225S	SatinSheet Corner 4Direction midi set - wide	IM4147S SatinSheet 2Direction w/elastic-wide	IM4115S SatinSheet 4Direction - midi
IM4226S	SatinSheet Corner 4Direction midi set - double	IM4137S SatinSheet 2Direction w/elastic-double	IM4115S SatinSheet 4Direction - midi
IM4227S	SatinSheet Corner DrawSheet midi set - wide	IM4147S SatinSheet 2Direction w/elastic - wide	IM4118S SatinSheet DrawSheet - midi
IM4228S	SatinSheet Corner DrawSheet midi set - double	IM4137S SatinSheet 2Direction w/elastic-double	IM4118S SatinSheet DrawSheet - midi
IM4229S	SatinSheet Corner 4Direction maxi set - wide	IM4147S SatinSheet 2Direction w/elastic - wide	IM4121S SatinSheet 4Direction - maxi
IM4230S	SatinSheet Corner 4Direction maxi set - double	IM4137S SatinSheet 2Direction w/elastic - double	IM4121S SatinSheet 4Direction - maxi
IM4231S	SatinSheet Corner 4Direction w/handle midi set	IM4107S SatinSheet 2Direction w/elastic	IM4115SH SatinSheet 4Direction w/handles- midi
IM4251S	SatinSheet 4Direction maxi midi set - small		

Combinaciones

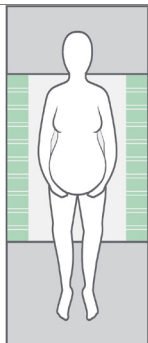

Article no. BaseSheet - Mini

IM4133S	SatinSheet 2Direction mini - small
IM4108S	SatinSheet 2Direction mini
IM4175S	SatinSheet 2Direction mini - wide
IM4178S	SatinSheet 2Direction mini - double

BaseSheet - Mini puede combinarse con:

Article no. DrawSheet, 4Direction and PillowCase

IM4116S	SatinSheet drawSheet - mini
IM4110S	In2Sheet 4Direction w/wings - mini
IM4110SH	In2Sheet 4Direction w/wings + handles - mini
IM4117S	SatinSheet 2Direction PillowCase

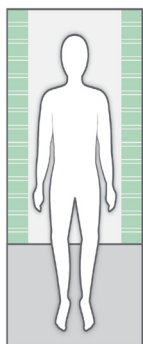

Article no. BaseSheet - Midi

IM4119S	SatinSheet 2Direction midi small
IM4113S	SatinSheet 2Direction midi
IM4176S	SatinSheet 2Direction midi - wide
IM4179S	SatinSheet 2Direction midi - double

BaseSheet - Midi puede combinarse con:

Article no. DrawSheet, 4Direction and PillowCase

IM4118S	SatinSheet DrawSheet - midi
IM4115S	SatinSheet 4Direction - midi
IM4115SH	SatinSheet 4Direction w/handles - midi
IM4121S	SatinSheet 4Direction - maxi
IM4121SH	SatinSheet 4Direction w/handles - maxi
IM4117S	SatinSheet 2Direction PillowCase

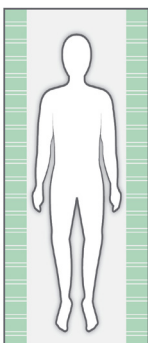

Article no. BaseSheet - Maxi

IM4181S	SatinSheet 2Direction maxi - small
IM4114S	SatinSheet 2Direction maxi
IM4177SH	SatinSheet 2Direction maxi - wide
IM4180S	SatinSheet 2Direction maxi - double
IM4122S	SatinSheet 2Direction 180cm bed

Article no. BaseSheet - Maxi Corner

IM4107S	SatinSheet 2Direction Corner
IM4147S	SatinSheet 2Direction Corner - wide
IM4137S	SatinSheet 2Direction Corner - double

Article no. BaseSheet - Maxi Fit

IM4112S	SatinSheet 2Direction Fit
IM4142S	SatinSheet 2Direction Elastic Fit

Article no. BaseSheet - Mini, Midi and Maxi Corner

IM4167S	SatinSheet 2Direction Corner - small -mini
IM4157S	SatinSheet 2Direction Corner - midi
IM4197S	SatinSheet 2Direction Corner - double - double - maxi

BaseSheet - Maxi/Corner/Fit puede combinarse con:

Article no. 4Direction and In2Sheet 4Direction

M4115S	SatinSheet 4Direction - midi
IM4115SH	SatinSheet 4Direction w/handles - midi
IM4140S	In2Sheet 4Direction w/wings - midi
IM4140SH	In2Sheet 4Direction - w/wings + handles - midi
IM4121S	SatinSheet 4Direction - maxi
IM4121SH	SatinSheet 4Direction w/handles - maxi

Recuerde usar la SatinSheet PillowCase (2D)

IM4117S	SatinSheet 2Direction PillowCase
---------	----------------------------------

Información de mantenimiento

Inspección

Primera inspección:

- Está el envoltorio intacto?
- Lea la etiqueta del envoltorio y compruebe el número del artículo y la descripción del producto.
- Compruebe que estén incluidas las Instrucciones resumidas (puede descargar el Manual/las Instrucciones de uso del sitio web www.etac.com o poniéndose en contacto con el Servicio de atención al cliente de Etac o con su distribuidor local)
- Compruebe la etiqueta del producto. ¿Incluye el número del artículo, la descripción del producto, el número del lote, las instrucciones de limpieza y el nombre del proveedor?

Inspección periódica:

- Asegúrese de que su sistema de movilización manual esté siempre en perfecto estado.
- Después de lavarlo, compruebe siempre los materiales, las costuras, las asas y las hebillas.
- Si el producto presenta signos de desgaste y rotura, deberá retirarlo inmediatamente de servicio.



Inspección visual/Comprobación del producto:

Asegúrese de que los materiales, las costuras, las puntadas, las asas y las hebillas estén intactos/perfectos.

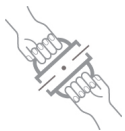

Carga o esfuerzo mecánicos/Comprobación de las asas:

Tire con fuerza de las asas en direcciones opuestas y verifique el material, las costuras y las puntadas.

Comprobación de las hebillas:

Fije las hebillas y tire de ellas en direcciones opuestas, verifique la hebilla y las puntadas.



Test de estabilidad:

Intente doblar el producto y compruebe que parezca firme, estable y sólido.



Comprobación de la fricción baja/alta:

Coloque el producto sobre una superficie firme o una cama, ponga las manos sobre el material y compruebe la fricción deslizando las manos sobre el producto en sentido ascendente y descendente.

Fricción baja: se deslizan sin esfuerzo.

Fricción alta: no se deslizan/mueven.

Compruebe:

Dispositivos de ayuda de traslado manual con asas, correas y hebillas:



Dispositivos de ayuda de traslado manual para el traslado sentado y tumbado con una fricción alta o baja:

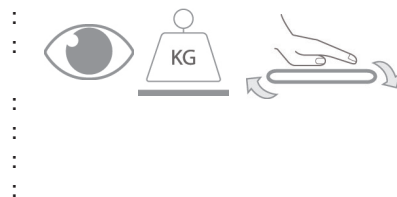

Año, mes y día de producción



El producto se puede desechar de conformidad con la normativa nacional.



Leer el manual de usuario



Etac Immedia A/S
Parallelvej 3
DK-8751 Gedved
www.etac.com

UK Responsible Person.
"Etac Ltd. Unit D4A, Coombswood Business Park East,
Coombswood Way Halesowen, West Midlands B62 8BH"

E-mail: enquiries@etac.uk.r82.com
Website: www.etac.com/uk
Phone: +44 0121 561 222



 **etac**[®]
Creating Possibilities

Short Instruction

IMM1026_SI.VER13.2022-05-16

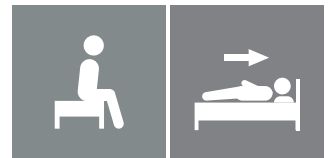

	Article no.	Description	Size (mm)
	IM4116S	SatinSheet DrawSheet - mini	W2000xL1000
	IM4118S	SatinSheet DrawSheet - midi	W2000xL1400
Combinations:	IM4133S	SatinSheet 2Direction mini - small	W1950xL1050 (satin W600xL1050)
	IM4108S	SatinSheet 2Direction mini	W1950xL1050 (satin W700xL1050)
	IM4175S	SatinSheet 2Direction mini - wide	W2300xL1050 (satin W850xL1050)
	IM4178S	SatinSheet 2Direction mini - double	W2300xL1050 (satin W960xL1050)
	IM4119S	SatinSheet 2Direction midi - small	W2000xL1400 (satin W600xL1400)
	IM4113S	SatinSheet 2Direction midi	W2000xL1400 (satin W700xL1400)
	IM4176S	SatinSheet 2Direction midi - wide	W2300xL1400 (satin W850xL1400)
	IM4179S	SatinSheet 2Direction midi - double	W2300xL1400 (satin W960xL1400)
	IM4181S	SatinSheet 2Direction maxi - small	W2000xL2000 (satin W600xL2000)
	IM4114S	SatinSheet 2Direction maxi	W2000xL2000 (satin W700xL2000)
	IM4177S	SatinSheet 2Direction maxi - wide	W2300xL2000 (satin W850xL2000)
	IM4180S	SatinSheet 2Direction maxi - double	W2300xL2000 (satin W960xL2000)
	IM4122S	SatinSheet 2Direction 180 cm bed	W2800xL2000 (satin W600xL2000)
	IM4112S	SatinSheet 2Direction Fit	W900xL2000 (satin W700xL2000)
	IM4142S	SatinSheet 2Direction Elastic Fit	W900xL2000 (satin W700xL2000)
	IM4157S	SatinSheet 2Direction Corner - midi	W850xL2000 (satin W650xL1400)
	IM4107S	SatinSheet 2Direction Corner	W850xL2000 (satin W650xL2000)
	IM4147S	SatinSheet 2Direction Corner - wide	W1050xL2000 (satin W800xL2000)
	IM4137S	SatinSheet 2Direction Corner - double	W1200xL2000 (satin W900xL2000)
Set:	IM4201S	SatinSheet DrawSheet mini set	Incl. 4108S + IM4116S
	IM4205S	SatinSheet DrawSheet midi small set	Incl. 4119S + IM4118S
	IM4200S	SatinSheet DrawSheet midi set	Incl. 4113S + IM4118S
	IM4202S	SatinSheet DrawSheet maxi midi set	Incl. 4114S + IM4118S
	IM4208S	SatinSheet Corner DrawSheet midi set	Incl. 4107S + IM4118S

SatinSheet DrawSheet

immedia
by Etac

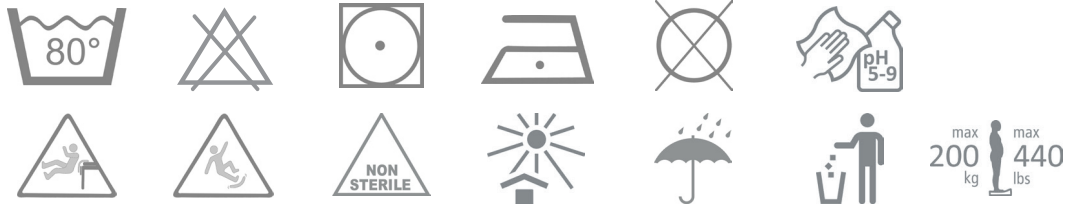

GB:

Material:

Polycotton: 50% cotton/50% polyester
Satin: Polyester.

**Never try to repair a product yourself.
Never use a defective product.**

Washing instructions:

Ironing improves the glide effect. Do not use fabric softener. Recommended to wash the product before use. This product can be cleaned with a solvent-free cleaning agent with a pH level between 5-9, or a 70% disinfection solution. The product should be checked regularly, preferably each time it is used and especially after wash. Check that there is no damage to seams or fabric.

SV:

Material:

Poly/bomull: 50% bomull / 50% polyester
Satin: Polyester.

**Försök aldrig reparera en produkt själv.
Använd aldrig en defekt produkt.**

Tvättinstruktioner:

Strykning förbättrar glideeffekten. Använd inte sköljmedel. Det rekommenderas att produkten tvättas före användning. Produkten kan rengöras med rengöringsmedel utan lösningsmedel och med pH-värde 5-9 eller med 70 % tvättsprit.

Produkten bör kontrolleras regelbundet, helst varje gång den har använts och särskilt efter tvätt. Kontrollera att sömmar och tyg inte är skadade.

NO:

Materiale:

Polybomull: 50 % bomull, 50 % polyester
Sateng: Polyester.

**Du må aldri forsøke å reparere produktet selv.
Hvis produktet er defekt, må det ikke brukes.**

Vaskeinstruks:

Stryking gir bedre glideeffekt. Ikke bruk tøymykner. Det anbefales å vaske produktet før bruk. Produktet kan vaskes med et løsemiddelfritt rengjøringsmiddel med pH mellom 5 og 9, eller desinfiseres med 70 % konsentrasjon.

Produktet skal kontrolleres regelmessig, fortrinnsvis ved hver bruk, og ekstra nøye etter vask. Kontroller at sømmer og stoff ikke er skadet.

DA:

Materiale:

Polycotton: 50 % bomuld/50 % polyester
Satin: Polyester.

**Reparér aldrig selv et produkt.
Et defekt produkt må ikke anvendes.**

Vaskeinstruktion:

Strygning forbedrer glideevnen. Tilsæt ikke skyllemiddel. Det anbefales at vaske produktet før brug. Produktet kan rengøres med et opløsningsmiddelfrit rengøringsmiddel med et pH-niveau mellem 5-9 eller med 70 % desinfektionsopløsning.

Produktet skal kontrolleres regelmæssigt, helst hver gang før brug. Vær specielt omhyggelig efter vask. Kontrollér at der ikke er skader ved sømme og stof.

FI:

Materiaali:

Polypuuvilla: 50 % puuvillaa / 50 % polyesteriä
Satiini: Polyesteriä.

**Älä koskaan yritä korjata tuotetta itse.
Viallista tuotetta ei saa käyttää.**

Pesuohjeet:

Silitäminen parantaa liukuominaisuuksia. Älä käytä huuhteluainetta. Tuotteen pesu ennen käyttöä on suositeltavaa. Tuote voidaan puhdistaa pesuaineella, joka ei sisällä liuottimia ja jonka pH on 5-9, tai 70-prosenttisella desinfiointiaineella.

Tuote on tarkistettava säännöllisesti, mieluiten joka kerta kun sitä käytetään ja erityisesti pesun jälkeen. Tarkista, ettei saumoissa tai kankaassa ole vaurioita.

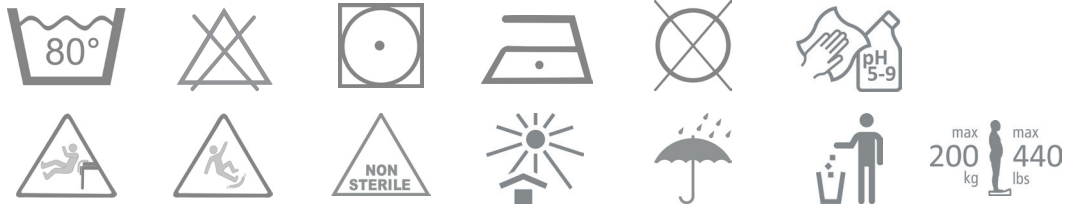

DE:

Material:

Poly-Baumwolle: 50 % Baumwolle und 50 % Polyester
Satin: Polyester.

**Niemals versuchen, ein Produkt eigenhändig zu reparieren.
Verwenden Sie niemals ein defektes Produkt.**

Waschanleitung:

Bügeln verstärkt den Gleiteffekt. Keinen Weichspüler verwenden.
Es ist empfehlenswert, dass Produkt vor der ersten Nutzung zu waschen.
Das Produkt kann mit einem lösungsmittelfreien Mittel mit einem pH-Wert von 5-9 oder einer 70%igen Desinfektionslösung gereinigt werden.

Das Produkt sollte regelmäßig überprüft werden, möglichst bei jeder Verwendung und vor allem nach dem Waschen. Es ist sicherzustellen, dass an Nähten oder im Stoff keinerlei Schäden vorliegen.

NL:

Material:

Polykatoen: 50% katoen/50% polyester
Satin: Polyester.

**Probeer een product nooit zelf te repareren.
Gebruik nooit een defect product.**

Wasinstructies:

Strijken verbetert het glijeffect. Geen wasverzachter toevoegen.
We adviseren om het product voor gebruik te wassen.
Dit product kan ook worden gereinigd met een reinigingsmiddel dat geen oplosmiddel bevat en een pH-waarde tussen 5 en 9 heeft. U kunt ook een ontsmettingsmiddel met een concentratie van 70% gebruiken.

Het product moet regelmatig worden gecontroleerd, bij voorkeur voor elk gebruik, en met name na het wassen. Controleer op schade aan de naden en de stof.

FR:

Matériaux :

Polycoton : 50 % coton / 50 % polyester
Satin : Polyester.

**N'essayez jamais de réparer un produit vous-même.
N'utilisez jamais un produit défectueux.**

Instructions de lavage :

Repasser améliore l'effet de glisse. Ne pas ajouter d'adoucissant.
Il est conseillé de laver le produit avant son utilisation.
Le produit peut être nettoyé avec un agent nettoyant sans solvant, de pH compris entre 5 et 9, ou une solution désinfectante diluée à 70 %.

Le produit doit être vérifié régulièrement, de préférence chaque fois qu'il est utilisé, et surtout après un lavage. Vérifiez qu'il n'y a aucun dommage au niveau des coutures ou du tissu.

IT:

Materiale:

Policotone: 50% cotone, 50% poliestere
Raso: Poliestere.

**Non tentare mai di riparare un prodotto da soli.
Non utilizzare mai un prodotto difettoso.**

Istruzioni di lavaggio:

La stiratura migliora l'effetto di scorrimento. Non aggiungere ammorbidente. Si consiglia di lavare il prodotto prima dell'uso.
Lavare il prodotto utilizzando un detergente privo di solventi con pH compreso tra 5 e 9 oppure una soluzione disinfettante al 70%.

Controllare il prodotto regolarmente, preferibilmente ogni volta che viene utilizzato e in particolare dopo il lavaggio. Controllare che non vi siano lacerazioni alle cuciture o al tessuto.

ES:

Material:

Polialgodón: 50 % algodón / 50 % poliéster.
Raso: 100 % poliéster.

**No intente reparar usted mismo el producto.
No utilice nunca un producto defectuoso.**

Instrucciones de lavado:

El planchado mejora el efecto deslizante. No utilizar suavizante.
Se recomienda lavar el producto antes de usarlo.
El producto se puede limpiar con un agente limpiador sin disolventes con un nivel de pH entre 5-9, o una solución de desinfección al 70 %.

El producto debería revisarse con regularidad, preferentemente cada vez que se use y, especialmente, después de haberlo lavado. Compruebe que las costuras o el tejido no estén dañados.

Illustrations

Positioning different sizes of SatinSheet BaseSheet 2Direction on a mattress

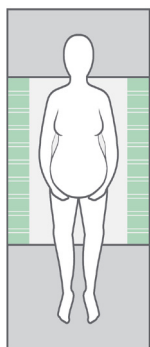

100 x 200 cm

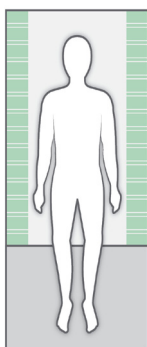

140 x 200 cm

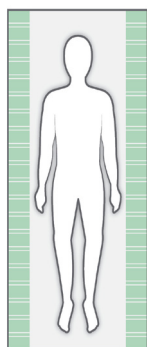

200 x 200 cm

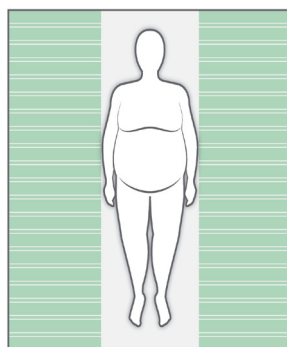

230 x 200 cm

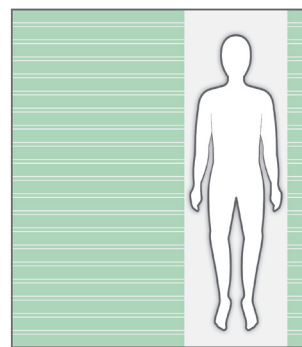

280 x 200 cm

Positioning different sizes of SatinSheet DrawSheet placed correct on top of SatinSheet 2Direction

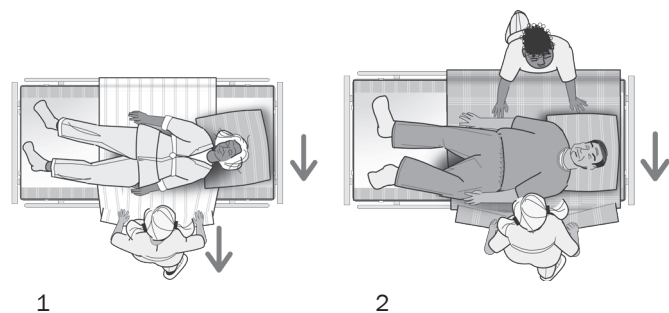
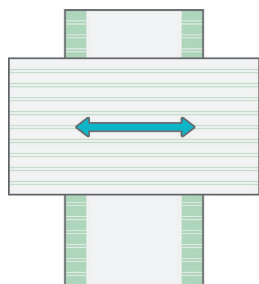

Check



Instruction for use



IMM1026_IFU.Version14.2022-05-17



SatinSheet DrawSheet

imedia
by Etac

Index

Illustrations	3
User manual - English	4
Bruksanvisning - Svenska.....	10
Bruksanvisning - Norsk	16
Brugervejledning - Dansk.....	22
Käyttöohjeet - Suomi.....	28
Gebrauchsanweisung - Deutsch	34
Gebruiksaanwijzing - Nederlands.....	40
Instruction d'utilisation - Français.....	46
Istruzioni per l'uso - Italiano.....	52
Instrucciones de uso - Español	58

See www.etac.com



Illustrations

Positioning different sizes of SatinSheet BaseSheet 2Direction on a mattress

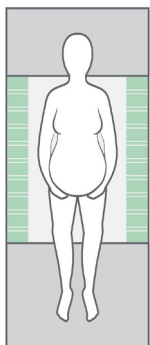

100 x 200 cm

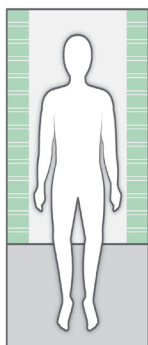

140 x 200 cm

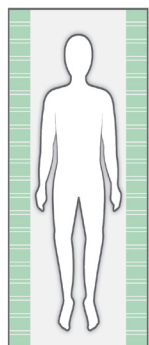

200 x 200 cm

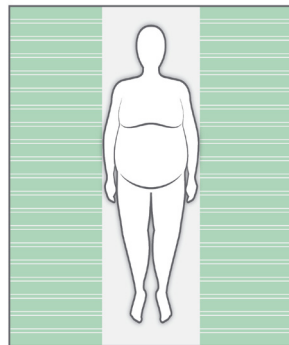

230 x 200 cm

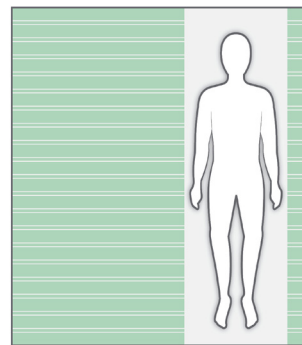

280 x 200 cm

Positioning different sizes of SatinSheet DrawSheet placed correct on top of SatinSheet 2Direction

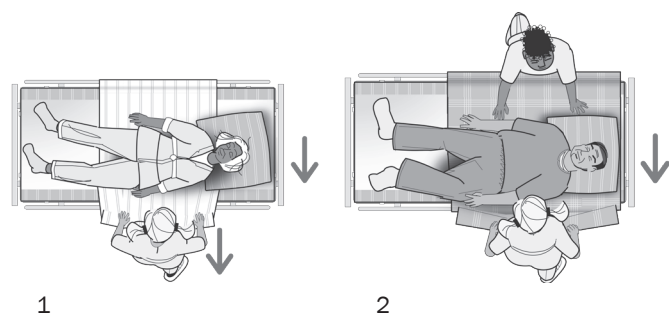
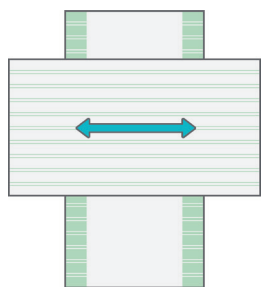

1

2

General

Thank you for choosing an Etac product.

To avoid accidents and injury when moving and handling the products, read the manual carefully.

The person described as “the user” in this user manual is the person who is lying or sitting on the product. The carer or carers are the people who manoeuvre the product.



This symbol appears alongside the text in the manual. It draws the reader’s attention to points at which there may be a risk to the health and safety of the user or carer.

These products comply with the standards applicable for Class 1 products in the Medical Device Regulation (EU) 2017/745 on medical devices.

At Etac we strive to improve our products all the time and therefore we reserve the right to make changes to products without prior warning. All measurements given on illustrations and similar material are for guidance only and Etac cannot be held liable for errors and defects.

The information given in this manual, including recommendations,

combinations and sizing, does not apply to special orders and modifications. If the customer makes adjustments, repairs or combinations not predetermined by Etac, the Etac CE certification and Etac warranty will not be valid. If in doubt, please contact Etac.

Warranty: Two-year warranty on material and manufacturing defects, provided that the product is used correctly.

Expected lifetime: The device has an expected service life of 1 to 2 years under normal use. The service life of the device varies depending on usage frequency, loads and how often and how it is washed.

For further information on the Etac transfer range, see www.etac.com.

In case of an adverse event occurred in relation to the device, incidents should be reported to your local dealer and the national competent authority in a timely manner. The local dealer will forward information to manufacturer.

Symbols in general



Washing



Disinfect / Wipe off



Warning



Manufacturer



Do not bleach



Never leave on the floor



Production year, month and day
YYYY-MM-DD



CE -certification



Tumbledry



Risk of sliding down



Batch no./Lot no.



Keep dry



Iron



Keep out of the sun



User mass limit =
maximum rated load



Non sterile



Do not dryclean



Read the user manual



The product can be scrapped according to national regulations



Article number



Medical device

Intended use

DrawSheets should always be used in combination with a SatinSheet product.

DrawSheet models IM4116S and IM4118S are two different DrawSheets that can be used with BaseSheet. (SatinSheet). DrawSheet can be used in manual handling from side to side. SatinSheet 4Direction can be used for manual handling from

side to side, and up and down in the bed. The SatinSheet range comprises different models of BaseSheet with low-friction material and DrawSheets. The choice of model or combination is made with reference to the user’s functions and needs and the carers’ working environment.

Intended environment

Acute care, Long-term care, Home care

Practical handling

Positioning

Position SatinSheet 2Direction with the low-friction material facing upwards in the middle of the bed (Illustrations). Lay DrawSheet over SatinSheet 2Direction. All SatinSheet models have a “this side up” label to help ensure that the

correct side is facing upwards in the bed. An information label, describing the correct use of the product, is sewn into all SatinSheet models/products.

Use

If the user needs help to turn, SatinSheet is ideal when used with DrawSheet. The draw sheet helps the user turn from side to side in the bed. SatinSheet 2Direction can be used to help move the user up and down in the bed and from one side to the other (Illustration 1).

Turning is achieved by grasping the sheet at the user’s hips and shoulders. To achieve a better ergonomic grip, the carer should grasp as much fabric as possible. Always work with flat wrists and weight transference.

Turning with SatinSheet can also be done by two carers. The carers work together. One carer helps pull on DrawSheet while the other carer pulls down on the mattress at the level of the user’s hips and shoulders, pushing gently.

Turn the user (Illustration 2). To lock the glide system after turning: Fold the excess material from DrawSheet under the mattress on both sides of the bed. Before locking the glide system under the mattress, any unevenness/creases should be smoothed to avoid decubitus. The carers pull simultaneously and diagonally from both sides.

Notice

Special features

Always check the product before use and after washing.

Never use a defective product. If the product shows signs of wear-and-tear, it must be scrapped.

Read these instructions carefully.

It is important that carers receive instruction in manual handling. Etac offers advice and training for carers. For further information, contact Etac.

Always use the correct manual handling techniques.

Encourage the user to assist where possible.

To ensure that the user feels safe and that every manual handling is smooth, always plan the manual handling in advance.



There is a risk that the user may slide off. Never leave the user alone on the edge of the bed.



Never leave the product on the floor.



Always conduct a risk assessment, and ensure that the assistive product can be used for the individual user and, in combination with other devices, that it is safe for the user and carers.



It is recommended that the guard rail is in place when the user is left on the glide system, unless a risk assessment has found that the user can be safely left on the glide system without the need of guard rails.



Always lock the glide system when you have completed the transfer.

If in any doubt - please contact Etac.

Material and cleaning

Material:

Polycotton: 55% cotton/45% polyester

Satin: Polyester.

The product should be checked regularly, preferably each time it is used, and especially after washing.

Check that there is no damage to seams or fabric.



**Never try to repair a product yourself.
Never use a defective product.**



Recommended to wash the product before use.

Washing instructions:

Ironing improves the glide effect.

Do not use fabric softener.

This product can be cleaned with a solvent-free cleaning agent with a pH level between 5 and 9, or a 70% disinfection solution.



Products and accessories

Article no.	Product Description	Size (mm)
IM4116S	SatinSheet DrawSheet - mini	W2000xL1000
IM4118S	SatinSheet DrawSheet - midi	W2000xL1400

Set

Article no.	Description	SatinSheet 2Direction BaseSheet		SatinSheet DrawSheet and SatinSheet 4Direction	
IM4201S	SatinSheet DrawSheet mini set	IM4108S	SatinSheet 2Direction mini	IM4116S	SatinSheet DrawSheet - mini
IM4205S	SatinSheet DrawSheet midi small set	IM4119S	SatinSheet 2Direction midi small	IM4118S	SatinSheet DrawSheet - midi
IM4200S	SatinSheet DrawSheet midi set	IM4113S	SatinSheet 2Direction midi	IM4118S	SatinSheet DrawSheet - midi
IM4202S	SatinSheet DrawSheet maxi midi set	IM4114S	SatinSheet 2Direction maxi	IM4118S	SatinSheet DrawSheet - midi
IM4208S	SatinSheet Corner DrawSheet midi set	IM4107S	SatinSheet 2Direction w/elastic	IM4118S	SatinSheet DrawSheet - midi

ILL.

GB

SV

NO

DA

FI

DE

NL

FR

IT

ES

Combinations

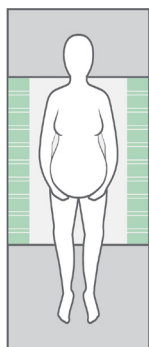

Article no.	BaseSheet - Mini
IM4133S	SatinSheet 2Direction mini - small
IM4108S	SatinSheet 2Direction mini
IM4175S	SatinSheet 2Direction mini - wide
IM4178S	SatinSheet 2Direction mini - double

BaseSheet - Mini can be combined with:

Article no.	DrawSheet and 4Direction
IM4116S	SatinSheet Drawsheet - mini
IM4110S	In2Sheet 4Direction w/wings - mini
IM4110SH	In2Sheet 4Direction w/wings + handles - mini

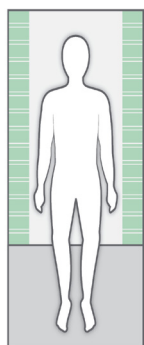

Article no.	BaseSheet - Midi
IM4119S	SatinSheet 2Direction midi - small
IM4113S	SatinSheet 2Direction midi
IM4176S	SatinSheet 2Direction midi - wide
IM4179S	SatinSheet 2Direction midi - double
IM4157S	SatinSheet 2Direction Corner - midi satin

BaseSheet - Midi can be combined with:

Article no.	DrawSheet and 4Direction and In2Sheet 4Direction
M4118S	SatinSheet Drawsheet - midi
IM4115S	SatinSheet 4Direction - midi
IM4115SH	SatinSheet 4Direction w/handles - midi
IM4140S	In2Sheet 4Direction w/wings - midi
IM4140SH	In2Sheet 4Direction w/wings + handles - midi

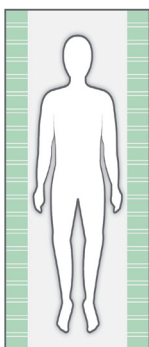

Article no.	BaseSheet - Maxi
IM4181S	SatinSheet 2Direction maxi - small
IM4114S	SatinSheet 2Direction maxi
IM4177S	SatinSheet 2Direction maxi - wide
IM4180S	SatinSheet 2Direction maxi - double
IM4122S	SatinSheet 2Direction 180 cm bed

Article no.	BaseSheet - Maxi Corner
IM4107S	SatinSheet 2Direction Corner
IM4147S	SatinSheet 2Direction Corner - wide
IM4137S	SatinSheet 2Direction Corner - double

Article no.	BaseSheet - Maxi Fit
IM4112S	SatinSheet 2Direction Fit
IM4142S	SatinSheet 2Direction Elastic Fit

BaseSheet - Maxi/Corner/Fit can be combined with:

Article no.	4Direction and In2Sheet 4Direction
M4115S	SatinSheet 4Direction - midi
IM4115SH	SatinSheet 4Direction w/handles - midi
IM4140S	In2Sheet 4Direction w/wings - midi
IM4140SH	In2Sheet 4Direction - w/wings + handles - midi
IM4121S	SatinSheet 4Direction - maxi
IM4121SH	SatinSheet 4Direction w/handles - maxi

Remember SatinSheet PillowCase (2D)

IM4117S	SatinSheet 2Direction PillowCase
---------	----------------------------------

Service information

Inspection

First inspection:

- Is the packaging intact?
- Read the label on the packaging and check the article no. and product description
- Check that Short Instruction is enclosed – updated User Manual/Instruction for use can be downloaded from www.etac.com or contact your Etac Customer Service or the local dealer.
- Check the label on the product - does it include article no., product description, lot/batch no., cleaning instructions and supplier name?

Periodic Inspection:

- Make sure that your Manual transfer system always is in a perfect condition.
- After wash – always check materials, stitching, handles, buckles.
- If the product shows signs of wear and tear, it must be removed from service immediately.



Visual inspection/Check the product:

Ensure that the materials, seams, stitching, handles, buckles are intact/faultless.



Stability test:

Try to bend the product verify that it feels firm, stable and solid.



Mechanical load or stress/Test handles:

Draw hard in the handles in opposite directions and control the material, seams and stitching.

Test buckles:

Lock the buckle and draw in opposite directions, control the buckle and the stitching.



Test low/high friction:

Place the product on a firm surface or a bed, place your hands on the material and test the friction by pushing your hands down into the product.

Low friction – slides effortlessly

High friction – no sliding/moving

Check:

Manual transfer aids with handles, straps and buckles:



Manual transfer aids with for sitting and lying transfer and with high or low friction:



Production year, month and day



The product can be scrapped in accordance with national regulations



Read the user manual

Allmänt

Tack för att du har valt en produkt från Etac.

För att undvika olyckor och personskador vid hantering och användning av produkten bör du läsa igenom bruksanvisningen noga.

Den person som beskrivs som "brukaren" i dessa instruktioner är personen som ligger eller sitter på produkten. Hjälparna är de personer som manövrerar produkten.



Den här symbolen förekommer i manualen tillsammans med text. Den vill påkalla uppmärksamhet när brukarens eller hjälparens säkerhet kan äventyras.

Produktene overholder standardene for Klasse 1-produkter i forskrift om medisinsk utstyr (EU) 2017/745 Medisinsk utstyr.

På Etac strävar vi efter att hela tiden förbättra våra produkter. Därför förbehåller vi oss rätten att göra ändringar av produkterna utan att meddela detta i förväg. Alla mått som anges på bilder och i liknande material är endast vägledande. Etac kan inte hållas ansvariga för felaktigheter och brister.

Informationen i dessa instruktioner, inklusive rekommendationer, kombinationer och storlekar, gäller inte för specialbeställningar

och modifikationer. Om kunden gör några ändringar, reparationer eller kombinationer som inte har godkänts av Etac, upphör Etacs CE-certifiering och garanti att gälla. Kontakta Etac om du har några frågor.

Garanti: Två års garanti för material- och tillverkningsfel, under förutsättning att produkten används på rätt sätt.

Förväntad livslängd: Enheten har en förväntad livslängd på 1 till 2 år vid normal användning. Enhetens livslängd varierar beroende på användningsfrekvens, belastning och hur ofta och hur den rengörs.

Mer information om Etacs sortiment av förflyttningsprodukter finns på www.etac.com.

I händelse av en biverkning i samband med produkten ska incidenter rapporteras till din lokala återförsäljare och den nationella behöriga myndigheten i tid. Den lokala återförsäljaren vidarebefordrar information till tillverkaren.

Allmänna symboler



Tvätt



pH-nivå / Avtorkning



Varning



Tillverkare



Ingen blekning



Lämna aldrig på golvet



Tillverkningsdatum: år, månad och dag



CE-certifiering



Torktumling



Nedglidningsrisk



Batchnr/partinr



Hålls torr



Strykning



Skydda från solljus



Största massa för brukare = maximal belastning



Icke steril



Ingen kemtvätt



Läs bruksanvisningen



Produkten kan avfallshandteras i enlighet med nationella bestämmelser



Artikelnummer



Medicinsk enhet

Avsedd användning

DrawSheet bör alltid användas tillsammans med SatinSheet-produkter.

DrawSheet-modellerna IM4116S och IM4118S är två olika DrawSheet som används med ett BaseSheet (SatinSheet). DrawSheet kan användas vid manuell hantering från sida till sida. SatinSheet 4Direction kan användas för manuell

hantering från sida till sida samt uppåt och nedåt i sängen. SatinSheet-sortimentet består av olika modeller av BaseSheet i material med låg friktion samt DrawSheet. Val av modell eller kombination görs med hänsyn till brukarens funktionsförmåga och behov samt hjälparens arbetsmiljö.

Avsedd miljö

Akutvård, långvarig vård och vård i hemmet.

Praktiskt handhavande

Placering

Placera SatinSheet 2Direction med materialet med låg friktion uppåt i mitten av sängen (bilder).

Lägg DrawSheet över SatinSheet 2Direction. Alla SatinSheet-modeller är försedda med etiketten "denna sida upp" för att

rätt sida ska vara vänd uppåt i sängen. En informationsetikett som beskriver korrekt användning av produkten är insydd i alla SatinSheet-modeller/produkter.

Användning

Om brukaren behöver hjälp med att vända sig fungerar SatinSheet perfekt med ett DrawSheet.

Draglakanet hjälper brukaren att vända sig från sida till sida i sängen.

Ett SatinSheet 2Direction kan användas för att hjälpa brukaren flytta sig uppåt och nedåt i sängen samt från en sida till en annan (bild 1).

Vändningen sker genom att hjälparen tar tag i lakanet vid brukarens höfter och axlar. För att få ett mer ergonomiskt grepp bör hjälparen ta tag i så mycket tyg som möjligt.

Arbeta alltid med raka handleder och viktöverföring.

Två hjälpare kan vända brukaren med SatinSheet tillsammans. Hjälparna samarbetar under arbetet. En hjälpare drar i DrawSheet medan den andra trycker försiktigt nedåt i madrassen i höjd med brukarens höfter och axlar.

Vänd brukaren (bild 2). Låsa glidsystemet efter vändningen: Vik in överskjutande material från DrawSheet under madrassen på båda sidor av sängen.

Innan glidsystemet låses under madrassen ska eventuella veck och ojämnheter rättas till för att undvika liggsår. Hjälparna drar samtidigt diagonalt från båda sidor.

Information

Särskilda egenskaper

Kontrollera alltid produkten före användning och efter rengöring.

Använd aldrig en defekt produkt. Om produkten är sliten måste den kasseras.

Läs dessa instruktioner noga.

Det är viktigt att hjälparna får instruktioner i manuell förflyttningsteknik. Etac erbjuder råd och utbildning för hjälpare. Kontakta Etac om du vill veta mer.

Använd alltid rätt förflyttningsteknik.

Uppmuntra brukaren att hjälpa till så mycket som möjligt.

Planera alltid förflyttningen i förväg så att brukaren känner sig trygg och förflyttningen går smidigt.



Det finns risk att brukaren kan glida av. Lämna aldrig brukaren ensam på sängkanten.



Lämna aldrig produkten på golvet.



Genomför alltid en riskbedömning, kontrollera att hjälpmedlet går att använda hos den enskilde brukaren och se till att det är säkert för brukaren och hjälparna att använda det tillsammans med andra hjälpmedel.



Vi rekommenderar att sängens grindar sitter på plats när brukaren lämnas på glidsystemet, såvida man inte har konstaterat i en riskbedömning att det är säkert att lämna brukaren på glidsystemet utan att grindar sitter på plats.



Lås alltid glidsystemet när förflyttningen är färdig.

Kontakta Etac om du har några frågor.

Material och rengöring

Material:

Poly/bomull: 55 % bomull/45 %polyester

Satin: Polyester.

Produkten bör kontrolleras regelbundet, helst varje gång den ska användas och särskilt efter tvätt.

Kontrollera att sömmar och tyg inte är skadade.



**Försök aldrig att reparera en produkt själv.
Använd aldrig en defekt produkt.**



**Det rekommenderas att produkten tvättas
före användning.**

Tvättinstruktioner:

Strykning förbättrar glideffekten.

Använd inte sköljmedel.

Produkten kan rengöras med rengöringsmedel utan lösningsmedel och med pH-värde 5–9 eller med 70 % tvättsprit.



Produkter och tillbehör

ArtikeInr	Produktbeskrivning	Storlek (mm)
IM4116S	SatinSheet DrawSheet - mini	W2000xL1000
IM4118S	SatinSheet DrawSheet - midi	W2000xL1400

Set

Artikel-nr	Beskrivning	SatinSheet 2Direction BaseSheet	SatinSheet DrawSheet och SatinSheet 4Direction
IM4201S	SatinSheet DrawSheet mini set	IM4108S SatinSheet 2Direction mini	IM4116S SatinSheet DrawSheet - mini
IM4205S	SatinSheet DrawSheet midi small set	IM4119S SatinSheet 2Direction midi small	IM4118S SatinSheet DrawSheet - midi
IM4200S	SatinSheet DrawSheet midi set	IM4113S SatinSheet 2Direction midi	IM4118S SatinSheet DrawSheet - midi
IM4202S	SatinSheet DrawSheet maxi midi set	IM4114S SatinSheet 2Direction maxi	IM4118S SatinSheet DrawSheet - midi
IM4208S	SatinSheet Corner DrawSheet midi set	IM4107S SatinSheet 2Direction w/elastic	IM4118S SatinSheet DrawSheet - midi

Kombinationer

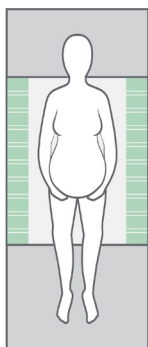

Article no. BaseSheet - Mini

IM4133S	SatinSheet 2Direction mini - small
IM4108S	SatinSheet 2Direction mini
IM4175S	SatinSheet 2Direction mini - wide
IM4178S	SatinSheet 2Direction mini - double

BaseSheet - Mini kan kombineras med:

Article no. DrawSheet and 4Direction

IM4116S	SatinSheet Drawsheet - mini
IM4110S	In2Sheet 4Direction w/wings - mini
IM4110SH	In2Sheet 4Direction w/wings + handles - mini

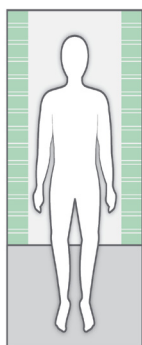

Article no. BaseSheet - Midi

IM4119S	SatinSheet 2Direction midi - small
IM4113S	SatinSheet 2Direction midi
IM4176S	SatinSheet 2Direction midi - wide
IM4179S	SatinSheet 2Direction midi - double
IM4157S	SatinSheet 2Direction Corner - midi satin

BaseSheet - Midi kan kombineras med:

Article no. DrawSheet and 4Direction and In2Sheet 4Direction

M4118S	SatinSheet Drawsheet - midi
IM4115S	SatinSheet 4Direction - midi
IM4115SH	SatinSheet 4Direction w/handles - midi
IM4140S	In2Sheet 4Direction w/wings - midi
IM4140SH	In2Sheet 4Direction w/wings + handles - midi

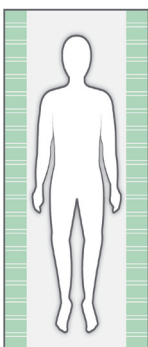

Article no. BaseSheet - Maxi

IM4181S	SatinSheet 2Direction maxi - small
IM4114S	SatinSheet 2Direction maxi
IM4177S	SatinSheet 2Direction maxi - wide
IM4180S	SatinSheet 2Direction maxi - double
IM4122S	SatinSheet 2Direction 180 cm bed

Article no. BaseSheet - Maxi Corner

IM4107S	SatinSheet 2Direction Corner
IM4147S	SatinSheet 2Direction Corner - wide
IM4137S	SatinSheet 2Direction Corner - double

Article no. BaseSheet - Maxi Fit

IM4112S	SatinSheet 2Direction Fit
IM4142S	SatinSheet 2Direction Elastic Fit

BaseSheet - Maxi/Corner/Fit kan kombineras med:

Article no. 4Direction and In2Sheet 4Direction

M4115S	SatinSheet 4Direction - midi
IM4115SH	SatinSheet 4Direction w/handles - midi
IM4140S	In2Sheet 4Direction w/wings - midi
IM4140SH	In2Sheet 4Direction - w/wings + handles - midi
IM4121S	SatinSheet 4Direction - maxi
IM4121SH	SatinSheet 4Direction w/handles - maxi

Kom ihåg SatinSheet PillowCase (2D)

IM4117S	SatinSheet 2Direction PillowCase
---------	----------------------------------

Inspektion

Första inspektion:

- Är förpackningen oskadad?
- Läs etiketten på förpackningen och kontrollera artikelnummer och produktbeskrivning.
- Kontrollera att Kortinformationen har bifogats en aktuell bruksanvisning kan laddas ned från www.etac.se eller beställas via Etacs kundtjänst eller din lokala återförsäljare
- Kontrollera etiketten på produkten – innehåller den artikelnummer, produktbeskrivning, parti-/batchnummer, rengöringsinstruktioner och leverantörens namn?

Regelbundna inspektioner:

- Kontrollera att det manuella överflyttningssystemet alltid är i perfekt skick.
- Kontrollera alltid material, sömmar, handtag och spännen efter rengöring.
- Om produkten visar spår av förslitning måste den omedelbart tas ur bruk.



Visuell inspektion/kontrollera produkten:

Kontrollera att material, sömmar, stygn, handtag och spännen är hela/utan fel.



Stabilitetstest:

Försök att böja produkten för att kontrollera att den känns fast och stabil.



Mekanisk belastning/test av handtag:

Dra hårt i handtagen åt motsatt håll och kontrollera material, sömmar och stygn.

Test av spännen:

Stäng spännet och dra åt motsatt håll. Kontrollera spännet och stygnen.



Testa låg/hög friktion:

Placera produkten på en fast yta eller säng, lägg händerna på materialet och testa friktionen genom att trycka händerna ned mot produkten.

Låg friktion – glider enkelt

Hög friktion – glider/rör sig inte

Kontrollera:

Hjälpmiddel för manuell förflyttning med handtag, remmar och spännen:



Hjälpmiddel för manuell förflyttning, sittande och liggande med hög eller låg friktion:



Produktionsår, månad og dag



Produkten kan avfallshandteras i enlighet med nationella bestämmelser



Läs bruksanvisningen

Generelt

Takk for at du har valgt et produkt fra Etac.

Les bruksanvisningen grundig for å unngå uhell og skader under flytting og bruk av produktene.

Personen som betegnes som "brukeren" i denne bruksanvisningen er personen som ligger i, eller sitter på, produktet. Assistenten eller assistentene er personene som manøvrerer produktet.



Dette symbolet vises ved siden av teksten i bruksanvisningen. Den trekker leserens oppmerksomhet mot punkter hvor det kan være fare for brukerens eller assistentens helse eller sikkerhet.

Produktene overholder standardene for Klasse 1-produkter i Forskrift om medisinsk utstyr (EU) 2017/745 Medisinsk utstyr.

Hos Etac arbeider vi kontinuerlig med å forbedre produktene våre. Vi forbeholder oss derfor retten til å endre produktene uten ytterligere forvarsel. Alle mål i illustrasjoner og liknende materiell er kun veiledende. Etac er ikke ansvarlig for feil og defekter.

Innholdet i denne bruksanvisningen, inkludert anbefalinger, kombinasjoner og størrelser, gjelder ikke ved spesialbestillinger

eller modifikasjoner. Hvis kunden foretar justeringer, reparasjoner eller kombinasjoner som ikke er avtalt med Etac på forhånd, vil Etacs CE-sertifisering og garanti være ugyldig. Kontakt Etac hvis du er i tvil.

Garanti: To års garanti mot material- og produksjonsfeil forutsatt at produktet brukes på riktig måte.

Forventet levetid: Utstyret har en forventet levetid på 1 til 2 år under normal bruk. Utstyrets levetid varierer avhengig av brukshyppighet, belastning og hvor ofte og hvordan det blir vasket.

Se www.etac.no for mer informasjon om Etacs forflytningshjelpemidler.

Hvis det skulle oppstå en uønsket hendelse relatert til utstyret, skal hendelsen rapporteres til din lokale forhandler og nasjonale myndigheter innen rimelig tid. Den lokale forhandleren vil videregående informasjon til produsenten.

Generelle symboler



Vasking



pH-nivå / Tørkes av med klut



Advarsel



Produsent



Må ikke blekes



Etterlat ikke produktet på gulvet



Produksjonsår, måned og dag



CE-sertifisering



Tørkes i tørketrommel



Fare for nedglidning



Batchnummer / LOT-nummer.



Må holdes tørr



Strykes



Må ikke utsettes for sollys



Maks brukervekt = maksimalt testet belastning



Ikke steril



Må ikke renses



Les bruksanvisningen



Produktet kan kasseres i henhold til gjeldende regelverk.



Artikkelnummer



Medisinsk utstyr

Bruksområde

DrawSheet skal alltid brukes i kombinasjon med et SatinSheet-produkt.

DrawSheet-modellene IM4116S og IM4118S er to DrawSheet som kan brukes sammen med BaseSheet (SatinSheet).

DrawSheet kan brukes ved manuell forflytning fra side til side. SatinSheet 4Direction kan brukes til manuell forflytning fra

side til side og opp og ned i sengen. SatinSheet-produktene består av ulike BaseSheet-modeller med lavfrikksjonsmateriale og DrawSheet. Valg av modell eller kombinasjon gjøres med tanke på brukerens funksjonalitet og behov, samt assistentenes arbeidsmiljø.

Bruksmiljø

Akuttmottak, sykehus, hjemmesykepleie

Praktisk bruk

Plassering

Plasser SatinSheet 2Direction midt i sengen med lavfriksjonsmaterialet vendt opp (illustrasjon).

Legg DrawSheet over SatinSheet 2Direction. Alle SatinSheet-modeller har en etikett med "denne siden opp" som gjør det

enklere å kontrollere at riktig side vendes opp i sengen. Det er sydd fast en informasjonsetikett med beskrivelse av korrekt bruk av produktet i alle SatinSheet-modeller/-produkter.

Bruk

Hvis brukeren trenger hjelp til å vende seg, er SatinSheet en ideell løsning i kombinasjon med et DrawSheet.

Stikk-lakenet hjelper brukeren med å vende seg fra side til side i sengen.

Et SatinSheet 2Direction kan brukes til å hjelpe brukeren med å bevege seg opp og ned og fra side til side i sengen (illustrasjon 1).

Vending utføres ved å ta tak i lakenet ved brukerenes hofter og skuldre. Assistenten bør ta tak i så mye stoff som mulig for et mer ergonomisk riktig grep.

Assistenten må alltid ha flate h ndledd og bruke vektoverf ring.

Vending med SatinSheet kan ogs  utf res av to assistenter. Assistentene samarbeider. En assistent hjelper til med   trekke opp DrawSheet mens den andre assistenten trekker ned i h yde med brukerenes hofter og skuldre samtidig som han eller hun skyver forsiktig.

Vend brukeren (illustrasjon 2). L se glidesystemet etter vending: Brett overskuddsmaterialet fra DrawSheet inn under madrassen p  begge sider av sengen.

F r glidesystemet l ses under madrassen, m  alle ujevnheter og folder gattes ut for   forebygge trykks r. Assistentene trekker samtidig og diagonalt fra begge sider.

Merknad

Spesialfunksjoner

Produktet må alltid kontrolleres før bruk og etter rengjøring.

Hvis produktet er defekt, må det ikke brukes. Hvis produktet virker slitt, må det kastes.

Les bruksanvisningen grundig.

Det er viktig at assistenter får opplæring i manuell forflytning. Etac tilbyr rådgivning og opplæring av assistenter. Kontakt Etac for ytterligere informasjon.

Korrekte teknikker for manuell forflytning må alltid brukes.

Brukeren kan oppfordres til å bidra når det er mulig.

Den manuelle forflytningen må alltid planlegges på forhånd for å sikre at brukeren er trygg og at all manuell forflytning foregår så smidig som mulig.



Brukeren kan gli av utstyret. Brukeren må aldri forlates på sengekanten.



Produktet må aldri forlates på gulvet.



Det må alltid foretas en risikovurdering, og det må kontrolleres at hjelpemiddelet kan brukes sammen med den individuelle brukeren og i kombinasjon med annet utstyr slik at både brukeren og assistenten er trygg.



Det anbefales å bruke gavler når brukeren ligger på glidesystemet over tid, med mindre en risikovurdering har avdekket at brukeren kan ligge på glidesystemet uten gavler.



Glidesystemet må alltid låses når forflytningen er fullført.

Kontakt Etac hvis du er i tvil.

Materiale og rengjøring

Materiale:

Polybomull: 55 % bomull/45 % polyester
Sateng: Polyester.

Produktet skal kontrolleres regelmessig, fortrinnsvis ved hver bruk, og ekstra nøye etter vask.

Kontroller at sømmer og stoff ikke er skadet.



Du må aldri forsøke å reparere produktet selv. Hvis produktet er defekt, må det ikke brukes.



Anbefalt å vaske produktet før bruk.

Vaskeinstruks:

Stryking gir bedre glideeffekt.

Ikke bruk tøymykner.

Produktet kan vaskes med et løsemiddelfritt rengjøringsmiddel med pH mellom 5 og 9, eller desinfiseres med 70 % konsentrasjon.



Produkter og tilbehør

Artikkelnr.	Beskrivelse	Størrelse (mm)
IM4116S	SatinSheet DrawSheet - mini	W2000xL1000
IM4118S	SatinSheet DrawSheet - midi	W2000xL1400

Kombinasjoner

Artikkelnr.	Beskrivelse	SatinSheet 2Direction BaseSheet		SatinSheet DrawSheet og SatinSheet 4Direction	
IM4201S	SatinSheet DrawSheet mini set	IM4108S	SatinSheet 2Direction mini	IM4116S	SatinSheet DrawSheet - mini
IM4205S	SatinSheet DrawSheet midi small set	IM4119S	SatinSheet 2Direction midi small	IM4118S	SatinSheet DrawSheet - midi
IM4200S	SatinSheet DrawSheet midi set	IM4113S	SatinSheet 2Direction midi	IM4118S	SatinSheet DrawSheet - midi
IM4202S	SatinSheet DrawSheet maxi midi set	IM4114S	SatinSheet 2Direction maxi	IM4118S	SatinSheet DrawSheet - midi
IM4208S	SatinSheet Corner DrawSheet midi set	IM4107S	SatinSheet 2Direction w/elastic	IM4118S	SatinSheet DrawSheet - midi

Kombinasjoner

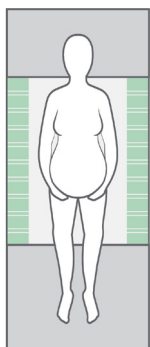

Article no. BaseSheet - Mini

IM4133S	SatinSheet 2Direction mini - small
IM4108S	SatinSheet 2Direction mini
IM4175S	SatinSheet 2Direction mini - wide
IM4178S	SatinSheet 2Direction mini - double

BaseSheet - Mini kan kombineres med:

Article no. DrawSheet and 4Direction

IM4116S	SatinSheet Drawsheet - mini
IM4110S	In2Sheet 4Direction w/wings - mini
IM4110SH	In2Sheet 4Direction w/wings + handles - mini

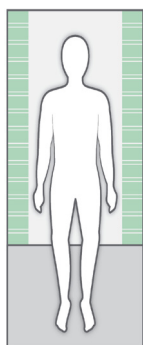

Article no. BaseSheet - Midi

IM4119S	SatinSheet 2Direction midi - small
IM4113S	SatinSheet 2Direction midi
IM4176S	SatinSheet 2Direction midi - wide
IM4179S	SatinSheet 2Direction midi - double
IM4157S	SatinSheet 2Direction Corner - midi satin

BaseSheet - Midi kan kombineres med:

Article no. DrawSheet and 4Direction and In2Sheet 4Direction

M4118S	SatinSheet Drawsheet - midi
IM4115S	SatinSheet 4Direction - midi
IM4115SH	SatinSheet 4Direction w/handles - midi
IM4140S	In2Sheet 4Direction w/wings - midi
IM4140SH	In2Sheet 4Direction w/wings + handles - midi

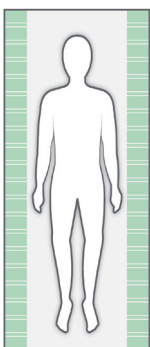

Article no. BaseSheet - Maxi

IM4181S	SatinSheet 2Direction maxi - small
IM4114S	SatinSheet 2Direction maxi
IM4177S	SatinSheet 2Direction maxi - wide
IM4180S	SatinSheet 2Direction maxi - double
IM4122S	SatinSheet 2Direction 180 cm bed

Article no. BaseSheet - Maxi Corner

IM4107S	SatinSheet 2Direction Corner
IM4147S	SatinSheet 2Direction Corner - wide
IM4137S	SatinSheet 2Direction Corner - double

Article no. BaseSheet - Maxi Fit

IM4112S	SatinSheet 2Direction Fit
IM4142S	SatinSheet 2Direction Elastic Fit

BaseSheet - Maxi/Corner/Fit kan kombineres med:

Article no. 4Direction and In2Sheet 4Direction

M4115S	SatinSheet 4Direction - midi
IM4115SH	SatinSheet 4Direction w/handles - midi
IM4140S	In2Sheet 4Direction w/wings - midi
IM4140SH	In2Sheet 4Direction - w/wings + handles - midi
IM4121S	SatinSheet 4Direction - maxi
IM4121SH	SatinSheet 4Direction w/handles - maxi

Husk SatinSheet PillowCase (2D)

IM4117S	SatinSheet 2Direction PillowCase
---------	----------------------------------

Inspeksjon

Første gangs inspeksjon:

- Er emballasjen hel?
- Les etiketten på emballasjen, og kontroller artikkelnummer og produktbeskrivelse.
- Kontroller at den kort brukerveiledning er vedlagt. Oppdatert bruksanvisning kan lastes ned fra www.etac.no. Du kan også kontakte Etacs kundeservice eller din forhandler.
- Kontroller etiketten på produktet. Inneholder den artikkelnummer, produktbeskrivelse, LOT-/batchnummer, vaskeanvisning og leverandørens navn?

Periodisk inspeksjon:

- Kontroller at det manuelle forflytningshjelpemiddelet alltid er i god stand.
- Materialer, sømmer, håndtak og spenner må alltid kontrolleres etter rengjøring.
- Hvis produktet har tegn på slitasje, må det umiddelbart tas ut av bruk.



Visuell inspeksjon / kontroller produktet:

Kontroller at materialene, sømmene, håndtakene og stroppene er hele og uten feil.



Stabilitetstest:

Forsøk å bøye produktet. Kontroller at det føles fast, stabilt og solid.



Mekanisk belastning eller stress /

Test av håndtak:

Trekk hardt i håndtakene i flere retninger, og kontroller materialet og sømmene.

Test av spenner:

Fest spennene, og trekk i flere retninger. Kontroller spennen og sømmene.



Test lav/høy friksjon:

Plasser produktet på fast underlag eller en seng, legg hendene på materialet og test friksjonen ved å presse hendene dine ned i produktet.

Lav friksjon – glir uten motstand

Høy friksjon – ingen glidning/bevegelse

Kontroller:

Manuelle forflytningshjelpemidler med håndtak, stropper og spenner:



Manuelle forflytningshjelpemidler for sittende og liggende forflytning med høy eller lav friksjon:



Produksjonsår, måned og dag



Produktet kan kasseres i henhold til gjeldende regelverk.



Les bruksanvisningen

Generelt

Tak, fordi du valgte et produkt fra Etac.

For at undgå ulykker og skader i forbindelse med håndtering og brug af produkterne, skal denne manual læses grundigt igennem.

Brugeren i denne manual er den person, der ligger eller sidder på produktet. Hjælperen er den person, der manøvrerer produktet.



Dette symbol forekommer i manualen sammen med teksten for at gøre opmærksom på tidspunkter, hvor der er risiko for brugerens eller hjælpernes sikkerhed.

Produktene overholder standardene for Klasse 1-produkter i Forordningen om medicinsk udstyr (EU) 2017/745 medicinsk udstyr

Hos Etac bestræber vi os på kontinuerligt at forbedre vores produkter. Vi forbeholder os derfor ret til at ændre produkterne uden forudgående meddelelse. Alle mål, der angives på illustrationer eller andet materiale, er kun vejledende, og der tages forbehold for fejl og mangler.

Informationen i denne manual, inkl. anbefalinger, kombinationer og størrelser, gælder ikke for specialtilpasninger og modifikationer. Hvis kunden foretager ændringer, reparationer eller kombinationer, der ikke er godkendt af Etac, bortfalder Etacs CE-mærkning, og Etacs garanti ophører. Ved tvivl kontakt venligst Etac.

Garanti: To år på materiale- og produktionsfejl ved korrekt anvendelse af produktet.

Forventet levetid: Produktet har en forventet levetid på 1-2 år ved normal brug. Levetiden for produktet varierer afhængigt af brugshyppighed, belastninger samt hvor ofte og hvordan det er blevet vasket.

For yderligere information om Etacs sortiment indenfor forflytning se www.etac.com.

Hvis der opstår en utilsigtet hændelse i forbindelse med produktet, skal hændelsen indberettes til den lokale forhandler og den nationale kompetente myndighed uden unødigt forsinkelse. Den lokale forhandler vil videresende oplysningerne til producenten.

Symboler



Vask



pH-værdi / Aftørring



Advarsel



Producent



Ingen blegning



Efterlad aldrig på gulv



Produktionsår, -måned og -dag



CE-certificering



Tørretumbling



Nedglidningsrisiko



Batch-/lotnummer



Opbevares tørt



Strygning



Beskyt mod sollys



Maks. brugervægt = maks. nominal belastning



Ikke-steril



Ingen rens



Læs manual



Produktet bortskaffes i henhold til nationale regler



Artikelnummer



Medicinsk udstyr

Tilsigtet anvendelse

DrawSheets anvendes altid i kombination med et SatinSheet-produkt. Modellerne IM4116S og IM4118S er to forskellige DrawSheets, som kan anvendes sammen med et BaseSheet. (SatinSheet). DrawSheet kan anvendes til forflytning fra side til side, SatinSheet 4Direction kan anvendes til forflytning fra side til

side og til forflytning op og ned i seng. SatinSheet-serien består af forskellige modeller af BaseSheet med friktionsnedsættende materiale samt DrawSheets. Valg af model eller kombination foretages under hensynstagen til brugerens funktionsniveau og behov samt hjælpernes arbejdsmiljø.

Tilsigtet miljø

Hospitaler, institutioner og hjemme.

Praktisk håndtering

Placering

Placer SatinSheet 2Direction med det friktionsnedsættende materiale opad i midten af sengen (Illustrationer). Placer derover DrawSheet. Alle modellerne af SatinSheet er forsynet med labelen "This side up", som angiver, hvilken side

der skal vende opad i sengen. Alle SatinSheet-produkter/-modeller har også en kort information omkring håndtering af produktet fastsyet på lagnet.

Anvendelse

Såfremt brugeren har brug for hjælp til vending, kan SatinSheet med fordel anvendes sammen med DrawSheet. Med træklandet kan brugeren hjælpes fra side til side i sengen. Med SatinSheet 2Direction kan brugeren hjælpes både op og ned i sengen samt fra side til side (Illustration 1).

Vending foretages ved at gribe i træklandet ved brugerens hofte og skulder. For at opnå et bedre ergonomisk greb, skal man tage fat i så meget materiale som muligt. Arbejd altid med strakte håndled og vægtoverføring.

Vending med SatinSheet kan også udføres med to hjælpere. De to hjælpere skal samarbejde. Den ene hjælper trækker i DrawSheet, og den anden trykker ned i madrassen omkring skulder og hofte og skubber langsomt.

Vend brugeren (Illustration 2). Efter vending låses glidesystemet ved at skubbe det overskydende materiale fra DrawSheet ind under madrassen på begge sider af sengen. Inden glidesystemet "låses" under madrassen, skal eventuelle ujævnheder/folder udjævnes for at undgå tryksår. Dette gøres ved samtidigt at trække diagonalt fra hver side.

ILL.

GB

SV

NO

DA

FI

DE

NL

FR

IT

ES

Information

Vær opmærksom på

Kontrollér altid produktet før brug og efter vask.

Anvend aldrig et defekt produkt. Ved tegn på slitage skal produktet kasseres.

Læs instruktionen grundigt.

Det er vigtigt at hjælpere og plejepersonale modtager instruktion omkring håndtering af forflytninger. Etac tilbyder hjælp og uddannelse af plejepersonale. Kontakt Etac for yderligere information.

Anvend altid korrekt forflytningsteknik.

Husk at udnytte brugerens egne ressourcer.

Planlæg forflytningen på forhånd, så det sker så trygt og problemfrit som muligt.



Nedglidningsrisiko, efterlad aldrig brugeren alene på sengekanten.



Efterlad aldrig produktet på gulvet.



Foretag altid en risikovurdering, og sørg for at hjælpemidlet kan anvendes til den enkelte bruger, og at det i kombination med andet udstyr er sikkert for brugeren og hjælperne.



Det anbefales at bruge sengeheste, når brugeren ligger på glidesystemet, medmindre en risikovurdering har fastslået, at det er sikkert at efterlade brugeren på glidesystemet uden brug af sengeheste.



Husk at låse glidesystemet efter endt forflytning.

Ved tvivlsspørgsmål – kontakt venligst Etac.

Materiale og rengøring

Materiale:

Polycotton: 55 % bomuld/45 % polyester

Satin: Polyester.

Produktet skal kontrolleres regelmæssigt, helst hver gang før brug. Vær specielt omhyggelig efter vask.

Kontrollér, at der ikke er skader ved sømme og stof.



**Reparér aldrig selv et produkt.
Et defekt produkt må ikke anvendes.**



**Det anbefales, at produktet vaskes før
ibrugtagning.**

Vaskeinstruktion:

Strygning forbedrer glideevnen.

Anvend ikke skyllemiddel.

Produktet kan rengøres med et opløsningsmiddelfrit rengøringsmiddel med et pH-niveau mellem 5-9 eller med 70 % desinfektionsopløsning.



Produkter og tilbehør

Varenr.	Beskrivelse	Størrelse i mm
IM4116S	SatinSheet DrawSheet - mini	W2000xL1000
IM4118S	SatinSheet DrawSheet - midi	W2000xL1400

Sæt

Varenr.	Beskrivelse	SatinSheet 2Direction BaseSheet		SatinSheet DrawSheet og SatinSheet 4Direction	
IM4201S	SatinSheet DrawSheet mini set	IM4108S	SatinSheet 2Direction mini	IM4116S	SatinSheet DrawSheet - mini
IM4205S	SatinSheet DrawSheet midi small set	IM4119S	SatinSheet 2Direction midi small	IM4118S	SatinSheet DrawSheet - midi
IM4200S	SatinSheet DrawSheet midi set	IM4113S	SatinSheet 2Direction midi	IM4118S	SatinSheet DrawSheet - midi
IM4202S	SatinSheet DrawSheet maxi midi set	IM4114S	SatinSheet 2Direction maxi	IM4118S	SatinSheet DrawSheet - midi
IM4208S	SatinSheet Corner DrawSheet midi set	IM4107S	SatinSheet 2Direction w/elastic	IM4118S	SatinSheet DrawSheet - midi

ILL.

GB

SV

NO

DA

FI

DE

NL

FR

IT

ES

Kombinationer

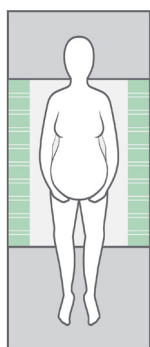

Article no. BaseSheet - Mini

IM4133S	SatinSheet 2Direction mini - small
IM4108S	SatinSheet 2Direction mini
IM4175S	SatinSheet 2Direction mini - wide
IM4178S	SatinSheet 2Direction mini - double

BaseSheet - Mini kan kombineres med:

Article no. DrawSheet and 4Direction

IM4116S	SatinSheet Drawsheet - mini
IM4110S	In2Sheet 4Direction w/wings - mini
IM4110SH	In2Sheet 4Direction w/wings + handles - mini

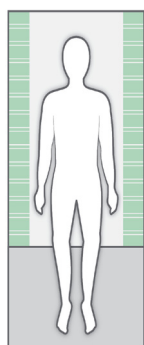

Article no. BaseSheet - Midi

IM4119S	SatinSheet 2Direction midi - small
IM4113S	SatinSheet 2Direction midi
IM4176S	SatinSheet 2Direction midi - wide
IM4179S	SatinSheet 2Direction midi - double
IM4157S	SatinSheet 2Direction Corner - midi satin

BaseSheet - Midi kan kombineres med:

Article no. DrawSheet and 4Direction and In2Sheet 4Direction

M4118S	SatinSheet Drawsheet - midi
IM4115S	SatinSheet 4Direction - midi
IM4115SH	SatinSheet 4Direction w/handles - midi
IM4140S	In2Sheet 4Direction w/wings - midi
IM4140SH	In2Sheet 4Direction w/wings + handles - midi

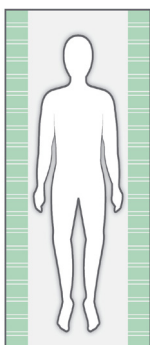

Article no. BaseSheet - Maxi

IM4181S	SatinSheet 2Direction maxi - small
IM4114S	SatinSheet 2Direction maxi
IM4177S	SatinSheet 2Direction maxi - wide
IM4180S	SatinSheet 2Direction maxi - double
IM4122S	SatinSheet 2Direction 180 cm bed

Article no. BaseSheet - Maxi Corner

IM4107S	SatinSheet 2Direction Corner
IM4147S	SatinSheet 2Direction Corner - wide
IM4137S	SatinSheet 2Direction Corner - double

Article no. BaseSheet - Maxi Fit

IM4112S	SatinSheet 2Direction Fit
IM4142S	SatinSheet 2Direction Elastic Fit

BaseSheet - Maxi/Corner/Fit kan kombineres med:

Article no. 4Direction and In2Sheet 4Direction

M4115S	SatinSheet 4Direction - midi
IM4115SH	SatinSheet 4Direction w/handles - midi
IM4140S	In2Sheet 4Direction w/wings - midi
IM4140SH	In2Sheet 4Direction - w/wings + handles - midi
IM4121S	SatinSheet 4Direction - maxi
IM4121SH	SatinSheet 4Direction w/handles - maxi

Husk SatinSheet PillowCase (2D)

IM4117S	SatinSheet 2Direction PillowCase
---------	----------------------------------

Inspektion

Første kontrol:

- Er emballagen intakt?
- Kontrollér label på emballagen, og kontrollér artikelnummeret og produktnavn.
- Tjek, at "Short Instruction" er vedlagt – opdateret Manual kan downloades fra www.etac.dk, eller kontakt Etacs kundeservice.
- Kontrollér label på produktet – findes artikelnummer, produktnavn, lot-/batchnummer og vaskeanvisning samt producent.
-

Gentagende inspektion:

- Kontrollér, at deres manuelle transfer system eller hjælpemiddel er i en perfekt stand.
- Efter vask – kontrollér altid materialer, sømme, syninger, håndtag og spænder.
- Viser produktet tegn på slitage, skal produktet straks kasseres.



Visuel inspektion/tjek produktet:

Kontrollér, at materialer, sømme, syninger, håndtag og spænder er intakte.l.



Stabilitetstest:

Prøv at bøje produktet; verificer, at det føles solidt og stabilt.



Mekanisk test/tjek håndtag:

Træk i håndtagene i hver sin retning, og kontrollér materialer, sømme og syninger.

Test spændet:

Lås spændet, og træk i hver sin retning; kontrollér spændet, sømme og syninger.



Test lav/høj friktion:

Placer produktet på en fast overflade eller sengen, placer hænderne på materialet og test friktionen ved at skubbe hænderne ned og fremad i produktet.

Lav friktion – glider uden problemer.

Høj friktion – glider ikke.

Kontroller:

Manuelle transferprodukter med håndtag, stropper og spænder:

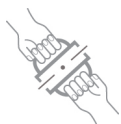

Manuelle transferprodukter til siddende og liggende forflytninger med lav eller høj friktion:



Produktionsår, -måned og -dag



Produktet bortskaffes i henhold til nationale regler.



Læs brugermanualen

Yleistä

Kiitos, että valitsit Etac-tuotteen.

Lue käyttöohjeet tarkkaan, jotta voit välttää onnettomuudet ja loukkaantumiset tuotteiden siirtämisen ja käsittelyn aikana.

Tässä käyttöohjeessa ”käyttäjä” on henkilö, joka makaa tai istuu tuotteessa. Hoitaja tai hoitajat ovat henkilöitä, jotka käsittelevät tuotetta.



Tämä symboli esiintyy tekstissä läpi koko ohjeen. Se kiinnittää lukijan huomion kohtiin, jotka voivat aiheuttaa vaaraa käyttäjän tai hoitajan terveydelle tai turvallisuudelle.

Tuotteet ovat lääkinällisistä laitteista annetussa Lääkinällisiä laitteita koskeva asetus (EU) 2017/745 luokkaan 1 kuuluvien tuotestandardien mukaisia.

Pyrimme Etacissa parantamaan tuotteitamme, joten pidätämme oikeuden tehdä muutoksia tuotteisiin ilman ennakkovaroitusta. Kaikki kuvissa ja vastaavassa materiaalissa esitetyt mitat ovat ohjeellisia, eikä Etac ole vastuussa niissä mahdollisesti olevista virheistä.

Tässä ohjekirjassa annetut tiedot, mukaan lukien suositukset, yhdistelmät ja mitoitus, eivät koske erikoistilauksia ja muunnettuja tuotteita. Jos asiakas tekee muutoksia, korjauksia tai yhdistelmiä, joita Etac ei ole ennalta määrittänyt, Etacin CE-sertifikaatti tai Etac-takuu eivät ole voimassa. Jos olet epävarma, ota yhteys Etaciin.

Takuu: Kahden vuoden takuu materiaali- ja valmistusvirheiden varalta edellyttäen, että tuotetta käytetään oikein.

Arvioitu käyttöikä: Laitteen arvioitu käyttöikä on 1–2 vuotta normaalissa käytössä. Laitteen käyttöikä vaihtelee käyttöiheyden, kuormien ja pesutiheyden ja -tavan mukaan.

Lisätietoja Etac-siirtolaitevalikoimasta saa osoitteesta www.etac.com.

Jos laitteen käytössä ilmenee haittatapahtuma, vaaratilanteet on ilmoitettava paikalliselle jälleenmyyjälle ja kansalliselle toimivaltaiselle viranomaiselle viipymättä. Paikallinen jälleenmyyjä välittää tiedot valmistajalle.

Yleistä symboleista



Pesu



pH-taso / Pyyhittävä



Varoitus



Valmistaja



Ei saa valkaista



Älä koskaan jätä lattialle



Valmistusvuosi, -kuukausi ja -päivä



CE-sertifioitu



Kuivausrumpu sallittu



Alas liukumisen vaara



Eränumero



Pidä kuivana



Silitys



Pidettävä poissa auringonvaloista



Käyttäjän massaraja = suurin sallittu kuormitus



Ei-steriili



Ei saa kuivapestä



Lue käyttöohje



Tuotteen voi romuttaa kansallisten määräysten mukaisesti.



Tuotenumero



Lääkinällinen laite

Käyttötarkoitus

DrawSheet-vetolakanoita on aina käytettävä yhdessä SatinSheet-tuotteen kanssa. DrawSheet-mallit IM4116S ja IM4118S ovat kaksi erilaista DrawSheet-vetolakanaa, joita voidaan käyttää BaseSheet-lakanan kanssa. (SatinSheet). DrawSheet-vetolakanaa voidaan käyttää käyttäjän manuaaliseen siirtämiseen puolelta toiselle. SatinSheet

4Direction -lakanaa voidaan käyttää käyttäjän manuaaliseen siirtämiseen vuoteen puolelta toiselle tai vuoteessa ylös- tai alaspäin. SatinSheet-valikoima sisältää erilaisia matalakitkaisen materiaalista valmistettuja BaseSheet-lakanamalleja ja DrawSheet-vetolakanoita. Mallin tai tuoteyhdistelmän valinnassa on huomioitava käyttäjän toimintakyky ja tarpeet sekä hoitajien työympäristö.

Käyttöympäristö

Akuuttihoito, pitkäaikaishoito, kotihoito

Käsittely

Sijoittaminen

Aseta SatinSheet 2Direction -lakana matalakitkainen materiaali ylöspäin vuoteen keskelle (kuvat).

Levitä DrawSheet-vetolakana SatinSheet 2Direction -lakanan päälle. Kaikissa SatinSheet-malleissa on tämä puoli ylöspäin

-merkintä, joka auttaa varmistamaan, että lakana tulee vuoteeseen oikeinpäin. Kaikkiin SatinSheet-malleihin/-tuotteisiin on ommeltu tarra, jossa kuvataan tuotteen asianmukainen käyttö.

Käyttö

Jos käyttäjä tarvitsee kääntymiseen apua, SatinSheet on ihanteellinen valinta DrawSheet-vetolakanan pariaksi. Vetolakana auttaa käyttäjää kääntymään vuoteessa kyljeltä toiselle.

SatinSheet 2Direction -lakanaa voidaan käyttää käyttäjän siirtämiseen vuoteessa ylös- tai alaspäin tai kyljeltä toiselle (Kuva 1).

Käyttäjä käännetään tarttumalla lakanaan käyttäjän lanteiden ja hartioiden kohdalta. Hoitajan on tartuttava kankaaseen mahdollisimman laajalta alueelta, jotta otteesta tulee ergonomisempi. Työskentele aina ranteet suorina ja painonsiirtoa hyödyntäen.

Käyttäjää voidaan kääntää SatinSheet-lakanalla myös kahden hoitajan voimin. Hoitajat tekevät yhteistyötä niin, että yksi hoitaja auttaa vetämään DrawSheet-lakanaa samalla kun toinen painaa patjaa alaspäin käyttäjän lanteiden ja hartioiden kohdalta ja työntää varovasti.

Käännä käyttäjä (Kuva 2). Liukumekanismin lukitseminen kääntämisen jälkeen: Taita DrawSheet-lakanan reunat patjan alle vuoteen kummaltakin puolelta.

Lakanan mahdolliset rypyt on oiottava ennen reunojen taittamista patjan alle, jotta makuuhaavariskiltä vältytään. Hoitajat vetävät molemmilta sivuilta samanaikaisesti ja poikittain.

Huomautus

Erityisominaisuudet

Tarkasta tuote aina ennen käyttöä ja pesun jälkeen.

Älä koskaan käytä viallista tuotetta. Jos tuotteessa ilmenee kulumisen merkkejä, se on hävitettävä.

Lue nämä ohjeet huolellisesti.

On tärkeää varmistaa, että hoitajat ovat saaneet manuaalisia hoitotoimenpiteitä koskevat ohjeet. Etac tarjoaa hoitajille neuvontaa ja koulutusta. Lisätietoja saat ottamalla yhteyden Etaciin.

Sovella aina oikeita manuaalisen hoidon tekniikoita.

Rohkaise käyttäjää toimimaan apuna mahdollisuuksien mukaan.

Suunnittele manuaalinen käsittely aina etukäteen, jotta varmistat, että käyttäjä tuntee olonsa turvalliseksi ja että käsittely sujuu jouhevasti.



Käyttäjän liukumisvaara. Älä koskaan jätä käyttäjää yksin sängynreunalle.



Älä koskaan jätä tuotetta lattialle.



Arvioi aina riskit ja varmista, että apuvälinettä voidaan käyttää kyseiselle käyttäjälle, että sitä voidaan käyttää muiden laitteiden kanssa ja että sen käyttö on turvallista niin käyttäjän kuin hoitajienkin kannalta.



Sängynlaita on suositeltavaa pitää nostettuna, kun käyttäjä jätetään liukuvalustalle, ellei riskinarvioinnissa ole todettu, että käyttäjän jättäminen liukuvalustalle ilman sängynlaitojen nostamista on turvallista.



Lukitse liukumekanismi aina, kun siirto on tehty.

Jos olet epävarma, ota yhteys Etaciin.

Materiaali ja puhdistus

Materiaali:

Polypuuvilla: 55 % puuvillaa / 45 % polyesteriä
Satiini: Polyesteriä.

Tuote on tarkastettava säännöllisesti, mieluiten jokaisella käyttökerralla ja erityisesti pesun jälkeen.

Tarkista, että saumoissa ja kankaassa ei näy vaurioita.



Älä koskaan yritä korjata tuotetta itse.
Älä koskaan käytä viallista tuotetta.



Tuotteen pesemistä suositellaan ennen käyttöä.

Pesuohteet:

Silittäminen parantaa liukuominaisuuksia.

Älä käytä huuhteluainetta.

Tuote voidaan puhdistaa liuotinaineettomalla pesuaineella, jonka pH on 5–9, tai 70-prosenttisella desinfiointiaineella.



Tuotteet ja varusteet

Tuotenumero	Tuotteen kuvaus	Koko (mm)
IM4116S	SatinSheet DrawSheet - mini	W2000xL1000
IM4118S	SatinSheet DrawSheet - midi	W2000xL1400

Setti

Tuote-numero	Kuvaus	SatinSheet 2Direction BaseSheet	SatinSheet DrawSheet ja SatinSheet 4Direction
IM4201S	SatinSheet DrawSheet mini set	IM4108S SatinSheet 2Direction mini	IM4116S SatinSheet DrawSheet - mini
IM4205S	SatinSheet DrawSheet midi small set	IM4119S SatinSheet 2Direction midi small	IM4118S SatinSheet DrawSheet - midi
IM4200S	SatinSheet DrawSheet midi set	IM4113S SatinSheet 2Direction midi	IM4118S SatinSheet DrawSheet - midi
IM4202S	SatinSheet DrawSheet maxi midi set	IM4114S SatinSheet 2Direction maxi	IM4118S SatinSheet DrawSheet - midi
IM4208S	SatinSheet Corner DrawSheet midi set	IM4107S SatinSheet 2Direction w/elastic	IM4118S SatinSheet DrawSheet - midi

ILL.

GB

SV

NO

DA

FI

DE

NL

FR

IT

ES

Yhdistelmät

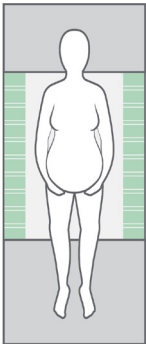

Article no.	BaseSheet - Mini
IM4133S	SatinSheet 2Direction mini - small
IM4108S	SatinSheet 2Direction mini
IM4175S	SatinSheet 2Direction mini - wide
IM4178S	SatinSheet 2Direction mini - double

BaseSheet - Mini voidaan yhdistää seuraaviin:

Article no.	DrawSheet and 4Direction
IM4116S	SatinSheet Drawsheet - mini
IM4110S	In2Sheet 4Direction w/wings - mini
IM4110SH	In2Sheet 4Direction w/wings + handles - mini

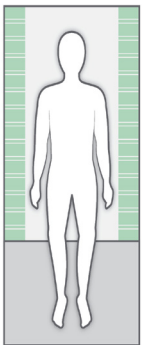

Article no.	BaseSheet - Midi
IM4119S	SatinSheet 2Direction midi - small
IM4113S	SatinSheet 2Direction midi
IM4176S	SatinSheet 2Direction midi - wide
IM4179S	SatinSheet 2Direction midi - double
IM4157S	SatinSheet 2Direction Corner - midi satin

BaseSheet - Midi voidaan yhdistää seuraaviin:

Article no.	DrawSheet and 4Direction and In2Sheet 4Direction
M4118S	SatinSheet Drawsheet - midi
IM4115S	SatinSheet 4Direction - midi
IM4115SH	SatinSheet 4Direction w/handles - midi
IM4140S	In2Sheet 4Direction w/wings - midi
IM4140SH	In2Sheet 4Direction w/wings + handles - midi

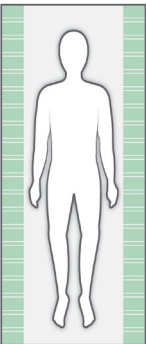

Article no.	BaseSheet - Maxi
IM4181S	SatinSheet 2Direction maxi - small
IM4114S	SatinSheet 2Direction maxi
IM4177S	SatinSheet 2Direction maxi - wide
IM4180S	SatinSheet 2Direction maxi - double
IM4122S	SatinSheet 2Direction 180 cm bed

Article no.	BaseSheet - Maxi Corner
IM4107S	SatinSheet 2Direction Corner
IM4147S	SatinSheet 2Direction Corner - wide
IM4137S	SatinSheet 2Direction Corner - double

Article no.	BaseSheet - Maxi Fit
IM4112S	SatinSheet 2Direction Fit
IM4142S	SatinSheet 2Direction Elastic Fit

BaseSheet - Maxi/Corner/Fit voidaan yhdistää seuraaviin:

Article no.	4Direction and In2Sheet 4Direction
M4115S	SatinSheet 4Direction - midi
IM4115SH	SatinSheet 4Direction w/handles - midi
IM4140S	In2Sheet 4Direction w/wings - midi
IM4140SH	In2Sheet 4Direction - w/wings + handles - midi
IM4121S	SatinSheet 4Direction - maxi
IM4121SH	SatinSheet 4Direction w/handles - maxi

Muista SatinSheet PillowCase (2D)

IM4117S	SatinSheet 2Direction PillowCase
---------	----------------------------------

Tarkistus

Ensimmäinen tarkistus:

- Onko pakkaus ehjä?
- Lue pakkauksen etiketti ja tarkista tuotenro ja -kuvaus.
- Tarkista, että lyhyt ohje on mukana – päivitetyn käyttöohjeen voi ladata osoitteesta www.etac.com tai pyytää asiakaspalvelusta tai paikalliselta jälleenmyyjältä.
- Tarkista tuotteessa oleva etiketti – onko siinä tuotenro, tuotokuvaus, erän nro, puhdistusohje ja toimittajan nimi?

Määräaikaistarkistus:

- Varmista, että manuaalinen siirtojärjestelmä on aina täydellisessä kunnossa.
- Tarkista pesun jälkeen aina materiaalit, ompeleet, lenkit/kahvat, soljet.
- Jos tuotteessa ilmenee kulumisen merkkejä, se on heti poistettava käytöstä.



Silmämääräinen tarkistus / Tarkista tuote:

Varmista, että materiaalit, saumat, ompeleet, lenkit/kahvat ja soljet ovat ehjiä/virheettömiä.



Vakaustesti:

Yritä taivuttaa tuotetta ja varmista, että se tuntuu lujalta, vakaalta ja kiinteältä.



Mekaaninen kuormitus tai jännitys / testaa lenkit/kahvat:

Vedä lenkeistä kovaa vastakkaisiin suuntiin ja tarkista materiaali, saumat ja ompeleet.

Testaa soljet:

Lukitse solki ja vedä vastakkaisiin suuntiin, tarkista solki ja ompeleet.



Testaa pieni/suuri kitka:

Aseta tuote kiinteälle pinnalle tai vuoteelle, aseta kätesi materiaalin päälle ja testaa kitka painamalla käsiäsi alaspäin tuotteen sisään.

Pieni kitka – liukuu ongelmitta
Suuri kitka – ei liukua/liikettä

Tarkista:

Manuaaliset siirtovälineet, joihin kuuluu lenkkejä/kahvoja, silmukoita ja solkia:



Manuaaliset siirtovälineet siirtoihin istuma-asennossa ja makuuasennossa suuri- tai pienikitkaiset:



Valmistusvuosi, -kuukausi ja -päivä



Tuotteen voi romuttaa kansallisten määräysten mukaisesti



Lue käyttöohje

Allgemeines

Vielen Dank, dass Sie sich für ein Produkt von Etac entschieden haben.

Um Unfälle und Verletzungen beim Handhaben und Verwenden des Produkts zu vermeiden, sollten Sie diese Anleitung sorgfältig durchlesen.

Mit „Benutzer“ wird in dieser Anleitung die Person bezeichnet, die auf dem Produkt sitzt oder liegt. Unter „Helfer“ wird die Person verstanden, die das Produkt handhabt.



Dieses Symbol erscheint neben dem Text in der Bedienungsanleitung. Es macht den Leser auf Situationen aufmerksam, die eine Gefahr für die Gesundheit und Sicherheit des Benutzers oder Helfers darstellen können.

Das Produkt erfüllt die Anforderungen der geltenden Normen für Produkte der Klasse 1 im Einklang mit der Richtlinie des Europäischen Rates (EU) 2017/745 über Medizinprodukte.

Bei Etac sind wir bemüht, unsere Produkte laufend zu verbessern und behalten uns daher das Recht vor, Änderungen ohne vorherige Ankündigung durchzuführen. Alle Abmessungen auf Abbildungen o. Ä. sind lediglich als Richtwerte zu verstehen und Etac haftet nicht für Fehler und Mängel.

Die in dieser Anleitung aufgeführten Angaben einschließlich

der Empfehlungen, Kombinationen und Größen gelten nicht für Sonderbestellungen und Modifikationen. Nimmt der Kunde Anpassungen, Reparaturen oder Kombinationen vor, die nicht von Etac spezifiziert wurden, wird die CE-Zertifizierung ungültig und die Garantieverpflichtung von Etac erlischt. Bei Fragen wenden Sie sich bitte an Etac.

Garantie: Zwei-Jahres-Garantie auf Material- und Herstellungsfehler, vorausgesetzt, dass das Produkt ordnungsgemäß verwendet wird.

Voraussichtliche Lebensdauer: Das Gerät hat bei normalem Gebrauch eine voraussichtliche Lebensdauer von 1 bis 2 Jahren. Die Lebensdauer des Geräts variiert und hängt von der Häufigkeit des Gebrauchs, der Belastung sowie von der Art und Häufigkeit der Reinigung ab.

Weitere Informationen über das Angebot von Etac siehe www.etac.com.

Alle unerwünschten Ereignisse, die im Zusammenhang mit dem Gerät auftreten, sollten unverzüglich Ihrem Händler vor Ort sowie der zuständigen Behörde gemeldet werden. Der Händler vor Ort leitet die Informationen an den Hersteller weiter.

Symbole allgemein



Waschen



pH-Wert /
Abwischen



Warnung



Hersteller



Nicht bleichen



Niemals auf dem
Boden liegen lassen!



Herstellungsjahr, -
monat und -tag



CE-Zertifizierung



Im Wäschetrockner
trocknen



Rutschgefahr



Batch-Nr./Lot-Nr.



Trocken halten



Bügeln



Keiner
Sonnenstrahlung
aussetzen!



Höchstgewicht des
Benutzers = maximale
Gewichtsbelastung



Nicht steril



Nicht chemisch
reinigen



Bedienungsanleitung
lesen



Das Produkt kann
in Übereinstimmung
mit den geltenden
nationalen Vorschriften
entsorgt werden.



Artikelnummer



Medizinprodukt

Verwendungszweck

Das DrawSheet sollte immer in Verbindung mit einem SatinSheet-Produkt verwendet werden. Die DrawSheets IM4116S und IM4118S sind zwei verschiedene DrawSheets für die Verwendung mit einem BaseSheet (SatinSheet). Das DrawSheet kann bei der manuellen Verlagerung von einer auf die andere Seite verwendet werden. Das SatinSheet 4Direction kann zur manuellen Verlagerung

von einer Seite auf die andere sowie auf- und abwärts im Bett verwendet werden. Zum SatinSheet-Sortiment gehören verschiedene Ausführungen des BaseSheet aus reibungsarmem Material sowie DrawSheet. Die Wahl des jeweiligen Modells oder einer Kombination erfolgt unter Berücksichtigung der Funktionstüchtigkeit und Bedürfnisse des Benutzers und des Arbeitsumfeldes der Helfer.

Vorgesehener Einsatzbereich

Akutbehandlung, Langzeitpflege, Hauspflege

Praktische Handhabung

Positionierung

Das SatinSheet 2Direction mit dem reibungsarmen Material nach oben in der Mitte des Bettes ausbreiten (Abb.).
Das DrawSheet über das SatinSheet 2Direction legen. Alle SatinSheet-Modelle haben ein Etikett mit dem Text „this side up“,

damit die richtige Seite im Bett nach oben ausgerichtet ist. Ein Informationsetikett mit einer Beschreibung der richtigen Verwendung des Produktes wird in alle SatinSheet-Modelle/-Produkte eingenäht.

Anlegen

Wenn der Benutzer Hilfe beim Umdrehen benötigt, sollte das SatinSheet zusammen mit einem DrawSheet verwendet werden. Das DrawSheet erleichtert dem Benutzer das Umdrehen von einer auf die andere Seite im Bett.
Ein SatinSheet 2Direction kann dazu verwendet werden, den Benutzer im Bett auf- und abwärts und von einer Seite auf die andere zu bewegen (Abb. 1).

Das Drehen wird durch Ergreifen des Lakens an Hüfte und Schultern des Benutzers bewerkstelligt. Um einen ergonomisch gute Griffigkeit zu erzielen, sollte der Helfer möglichst viel Stoff zu ergreifen versuchen.
Immer mit gestreckten Handgelenken und Gewichtsverlagerung arbeiten.

Das Umdrehen mit dem SatinSheet kann auch von zwei Helfern vorgenommen werden. Diese arbeiten wie folgt zusammen: Ein Helfer zieht am DrawSheet, während der andere die Matratze an Hüfte und Schultern des Benutzers herabzieht und sanft schiebt.

Den Benutzer umdrehen (Abb. 2). Sicherung des Gleitsystems nach dem Umdrehen: Den überschüssigen Stoff des DrawSheet auf beiden Seiten des Betts unter die Matratze ziehen.
Vor der Sicherung des Gleitsystems unter der Matratze sollten alle Unebenheiten/Falten zur Vermeidung von Dekubitus geglättet werden. Die Helfer ziehen gleichzeitig und diagonal von beiden Seiten.

ILL.

GB

SV

NO

DA

FI

DE

NL

FR

IT

ES

Hinweis

Besondere Hinweise

Das Produkt vor dem Gebrauch und nach dem Waschen überprüfen.

Niemals ein defektes Produkt verwenden! Produkte, die Anzeichen von Abnutzung zeigen, müssen entsorgt werden.

Diese Hinweise sind sorgfältig durchzulesen.

Es ist wichtig, dass sämtliche Helfer eine Einweisung in die Handhabung des Produkts erhalten. Etac bietet Beratung und Schulungen für Helfer an. Weitere Informationen erhalten Sie bei Etac.

Achten Sie auf die richtige Umsetz-/Umlagerungstechnik.

Der Benutzer ist aufzufordern, nach Möglichkeit Hilfe zu leisten.

Planen Sie den Vorgang stets im Voraus, damit alle Schritte reibungslos ablaufen und der Benutzer sich sicher fühlt.



Es besteht die Gefahr, dass der Benutzer abgleitet. Den Benutzer niemals allein auf der Bettkante zurücklassen!



Das Produkt niemals auf dem Boden liegen lassen!



Immer eine Risikobeurteilung vornehmen und sicherstellen, dass das Hilfsprodukt beim jeweiligen Benutzer und in Kombination mit anderen Geräten so verwendet werden kann, dass es für Benutzer und Helfer/Pfleger sicher ist.



Es empfiehlt sich, das Bettgitter nicht zu entfernen, wenn der Benutzer sich auf dem Gleitsystem befindet, sofern nicht im Rahmen einer Risikobeurteilung festgestellt wurde, dass der Benutzer ohne Bettgitter sicher auf dem Gleitsystem verbleiben kann.



Das Gleitsystem nach Abschluss der Verlegung immer befestigen.

Bei Fragen wenden Sie sich bitte an Etac.

Material und Reinigung

Material:

Poly-Baumwolle: 55 % Baumwolle / 45 % Polyester
Satin: Polyester.

Das Produkt sollte regelmäßig überprüft werden, möglichst bei jeder Verwendung und vor allem nach dem Waschen.

Es ist sicherzustellen, dass an Nähten oder im Stoff keinerlei Schäden vorliegen.



**Niemals versuchen, ein Produkt eigenhändig zu reparieren.
Niemals ein defektes Produkt verwenden!**



Es ist empfehlenswert, dass Produkt vor der ersten Nutzung zu waschen.

Waschanleitung:

Bügeln verstärkt den Gleiteffekt.

Keinen Weichspüler verwenden.

Das Produkt kann mit einem lösungsmittelfreien Mittel mit einem pH-Wert von 5-9 oder einer 70%igen Desinfektionslösung gereinigt werden.



Produkte und Zubehör

Artikel-Nr.	Beschreibung	Größe (mm)
IM4116S	SatinSheet DrawSheet - mini	W2000xL1000
IM4118S	SatinSheet DrawSheet - midi	W2000xL1400

Set

Artikel-Nr.	Beschreibung	SatinSheet 2Direction BaseSheet		SatinSheet DrawSheet und SatinSheet 4Direction	
IM4201S	SatinSheet DrawSheet mini set	IM4108S	SatinSheet 2Direction mini	IM4116S	SatinSheet DrawSheet - mini
IM4205S	SatinSheet DrawSheet midi small set	IM4119S	SatinSheet 2Direction midi small	IM4118S	SatinSheet DrawSheet - midi
IM4200S	SatinSheet DrawSheet midi set	IM4113S	SatinSheet 2Direction midi	IM4118S	SatinSheet DrawSheet - midi
IM4202S	SatinSheet DrawSheet maxi midi set	IM4114S	SatinSheet 2Direction maxi	IM4118S	SatinSheet DrawSheet - midi
IM4208S	SatinSheet Corner DrawSheet midi set	IM4107S	SatinSheet 2Direction w/elastic	IM4118S	SatinSheet DrawSheet - midi

ILL.

GB

SV

NO

DA

FI

DE

NL

FR

IT

ES

Kombinationen

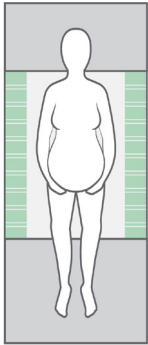

Article no.	BaseSheet - Mini
IM4133S	SatinSheet 2Direction mini - small
IM4108S	SatinSheet 2Direction mini
IM4175S	SatinSheet 2Direction mini - wide
IM4178S	SatinSheet 2Direction mini - double

BaseSheet - Mini ist kombinierbar mit:

Article no.	DrawSheet and 4Direction
IM4116S	SatinSheet Drawsheet - mini
IM4110S	In2Sheet 4Direction w/wings - mini
IM4110SH	In2Sheet 4Direction w/wings + handles - mini

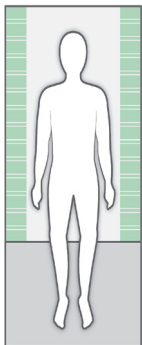

Article no.	BaseSheet - Midi
IM4119S	SatinSheet 2Direction midi - small
IM4113S	SatinSheet 2Direction midi
IM4176S	SatinSheet 2Direction midi - wide
IM4179S	SatinSheet 2Direction midi - double
IM4157S	SatinSheet 2Direction Corner - midi satin

BaseSheet - Midi ist kombinierbar mit:

Article no.	DrawSheet and 4Direction and In2Sheet 4Direction
M4118S	SatinSheet Drawsheet - midi
IM4115S	SatinSheet 4Direction - midi
IM4115SH	SatinSheet 4Direction w/handles - midi
IM4140S	In2Sheet 4Direction w/wings - midi
IM4140SH	In2Sheet 4Direction w/wings + handles - midi

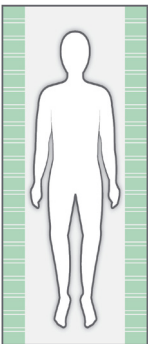

Article no.	BaseSheet - Maxi
IM4181S	SatinSheet 2Direction maxi - small
IM4114S	SatinSheet 2Direction maxi
IM4177S	SatinSheet 2Direction maxi - wide
IM4180S	SatinSheet 2Direction maxi - double
IM4122S	SatinSheet 2Direction 180 cm bed

Article no.	BaseSheet - Maxi Corner
IM4107S	SatinSheet 2Direction Corner
IM4147S	SatinSheet 2Direction Corner - wide
IM4137S	SatinSheet 2Direction Corner - double

Article no.	BaseSheet - Maxi Fit
IM4112S	SatinSheet 2Direction Fit
IM4142S	SatinSheet 2Direction Elastic Fit

BaseSheet - Maxi/Corner/Fit ist kombinierbar mit:

Article no.	4Direction and In2Sheet 4Direction
M4115S	SatinSheet 4Direction - midi
IM4115SH	SatinSheet 4Direction w/handles - midi
IM4140S	In2Sheet 4Direction w/wings - midi
IM4140SH	In2Sheet 4Direction - w/wings + handles - midi
IM4121S	SatinSheet 4Direction - maxi
IM4121SH	SatinSheet 4Direction w/handles - maxi

Denken Sie an das SatinSheet PillowCase (2D)

IM4117S	SatinSheet 2Direction PillowCase
---------	----------------------------------

Inspektionen

Erste Kontrolle:

- Ist die Verpackung unbeschädigt?
- Lesen Sie das Etikett auf der Verpackung und überprüfen Sie Artikelnummer und Produktbeschreibung.
- Überprüfen, ob die Kurzanleitung beigelegt ist - die aktualisierte Bedienungsanleitung kann von www.etac.com heruntergeladen werden oder ist beim Händler vor Ort erhältlich.
- Prüfen Sie das Etikett auf dem Produkt - sind Artikelnummer, Produktbeschreibung, Lot-/Batch-Nr., Reinigungsanleitungen und Anbieter aufgeführt?

Regelmäßige Kontrolle:

- Sicherstellen, dass das manuelle Transfer-/Umlagerungssystem immer in perfektem Zustand ist.
- Nach dem Waschen stets Material, Nähte, Griffschlaufen und Schnallen überprüfen.
- Wenn das Produkt Anzeichen von Abnutzung zeigt, darf es nicht mehr benutzt werden.



Inaugenscheinnahme/Produktüberprüfung:

Sicherstellen, dass Material, Nähte, Griffschlaufen und Schnallen unbeschädigt/fehlerfrei sind.



Stabilitätstest:

Das Produkt zu verbiegen versuchen, um zu überprüfen, ob es fest und stabil ist.

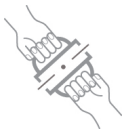

Mechanische Belastung/Griffschlaufen überprüfen:

Fest an den Griffschlaufen ziehen (in entgegengesetzte Richtung) und Material und Nähte überprüfen.

Schnallen überprüfen:

Ziehen Sie an der geschlossenen Schnalle und prüfen Sie Schnalle und Nähte.



Niedrige/hohe Reibung testen:

Das Produkt auf eine feste Unterlage oder ein Bett legen und die Reibung überprüfen, indem die Hände mit Druck über das Produkt gezogen werden.

Niedrige Reibung – müheloses Gleiten
Hohe Reibung – kein Gleiten/Bewegen

Überprüfen:

Manuelle Transfer-/Umlagerungshilfen mit Griffen, Riemen und Schnallen:



Manuelle Transfer-/Umlagerungshilfen für die sitzende und liegende Umlagerung mit hoher oder geringer Reibung:



Herstellungsjahr, -monat und -tag



Das Produkt kann in Übereinstimmung mit den geltenden nationalen Vorschriften entsorgt werden



Bedienungsanleitung lesen

Algemeen

Dank u dat u voor een van de producten van Etac hebt gekozen.

Lees de handleiding zorgvuldig door, om ongelukken en letsels bij het verplaatsen en hanteren van de producten te voorkomen.

De persoon die in deze gebruikershandleiding als 'de gebruiker' wordt aangeduid, is de persoon die op het product ligt of zit. De term 'verzorgers' wordt gebruikt voor de personen die het product hanteren.



Dit symbool wordt in de handleiding naast de tekst weergegeven. Het maakt de lezer attent op zaken die een gevaar kunnen vormen voor de gezondheid en de veiligheid van de gebruiker of verzorger.

De producten voldoen aan de normen die gelden voor klasse 1-producten volgens EU-richtlijn (EU) 2017/745 betreffende medische hulpmiddelen.

Bij Etac streven we naar voortdurende verbetering van onze producten en daarom behouden we ons het recht voor om onze producten zonder aankondiging vooraf te wijzigen. Alle maten op afbeeldingen en overige referentiematerialen gelden uitsluitend als indicatie en Etac kan niet aansprakelijk worden gesteld voor fouten en afwijkingen.

De informatie in deze handleiding, met inbegrip van aanbevelingen, combinaties en maten, gelden niet voor speciale orders en modificaties. Als de klant aanpassingen of reparaties uitvoert of combinaties maakt die niet vooraf door Etac zijn bepaald, zijn de door Etac aangebrachte CE-markering en de garantie van Etac niet langer geldig. Neem bij twijfel contact op met Etac.

Garantie: twee jaar garantie op materiaal- en productiefouten, op voorwaarde dat het product correct is gebruikt.

Verwachte levensduur: het product heeft bij normaal gebruik een levensduur van 1 à 2 jaar. De levensduur van het product hangt af van hoe vaak het wordt gebruikt, de belasting en hoe vaak en hoe het wordt gewassen

Ga voor meer informatie over het transferassortiment van Etac naar www.etac.com.

Mocht er een schadelijk incident plaatsvinden met het product, dan moet u dat tijdig melden aan de leverancier van het product en aan de bevoegde autoriteit in uw land. De leverancier geeft de informatie door aan de producent.

Algemene symbolen



Wassen



pH-waarde /Afnemen met een doekje



Waarschuwing



Fabrikant



Niet bleken



Nooit op de vloer laten liggen



Productiejaar, -maand en -dag



CE-certificering



Drogen in wasdroger



Risico dat de gebruiker naar beneden kan schuiven



Batchnr./Partijnr.



Droog bewaren



Strijken



Niet blootstellen aan zonlicht



Maximale massa gebruiker = maximale nominale belasting



Niet steriel



Niet chemisch reinigen



Lees de gebruikershandleiding



Het product kan worden afgevoerd volgens de nationale voorschriften



Artikelnummer



Medisch hulpmiddel

Beoogd gebruik

Gebruik DrawSheets altijd in combinatie met een SatinSheet-product.

De DrawSheet-uitvoeringen IM4116S en IM4118S zijn twee verschillende DrawSheets die in combinatie met een BaseSheet kunnen worden gebruikt. (SatinSheet).

DrawSheet kan worden gebruikt om een gebruiker handmatig van de ene zij naar de andere te draaien. SatinSheet 4Direction

kan worden gebruikt om een gebruiker in bed te draaien of hoger of lager te positioneren. Het SatinSheet-assortiment bevat diverse BaseSheet-uitvoeringen van materiaal met geringe wrijving en DrawSheets. De keuze van de uitvoering of combinatie hangt af van de beperkingen en behoeften van de gebruiker en de werkomgeving van de verzorger.

Beoogde gebruiksomgeving

Acute zorg, langdurige zorg, thuiszorg

Praktisch gebruik

Positionering

Plaats SatinSheet 2Direction met het materiaal met geringe wrijving naar boven gericht op het midden van het bed (afbeeldingen).

Leg een DrawSheet over de SatinSheet 2Direction. Alle SatinSheet-uitvoeringen zijn voorzien van een label met de

aanduiding 'deze kant boven' om ervoor te zorgen dat het product met de juiste zijde naar boven op het bed wordt geplaatst. Op alle SatinSheet-uitvoeringen/producten is een informatielabel genaaid, met aanwijzingen over het juiste gebruik van het product.

Gebruik

SatinSheet in combinatie met een DrawSheet is ideaal als een gebruiker hulp nodig heeft om te draaien.

Het glijlaken helpt de gebruiker om in bed van de ene zij naar de andere te draaien.

SatinSheet 2Direction kan worden gebruikt om de gebruiker te helpen om hoger of lager in bed te gaan liggen en om te draaien (afbeelding 1).

Draaien is mogelijk door het laken ter hoogte van de heupen en schouders van de gebruiker vast te pakken. Voor een optimale ergonomische greep moet de verzorger daarbij zo veel mogelijk stof vastpakken.

Werk altijd met gestrekte polsen en verplaatsing van het gewicht.

Het draaien met SatinSheet kan ook worden uitgevoerd door twee verzorgers. De verzorgers werken samen. De ene verzorger trekt aan de DrawSheet, terwijl de andere verzorger de matras voorzichtig indrukt ter hoogte van de heupen en schouders van de gebruiker.

Draai de gebruiker (afbeelding 2). Het glijsysteem na het draaien vastzetten: vouw het overtollige materiaal van de DrawSheet aan beide zijden van het bed onder de matras. Strijk alle oneffenheden/plooien glad voordat u het glijsysteem onder de matras vastzet, om decubitus te voorkomen. De verzorgers trekken tegelijkertijd en diagonaal vanaf beide zijden.

Let op

Speciale functies

Controleer het product voor elk gebruik en na het wassen.

Gebruik een product nooit als het defect is. Voer het product af als het tekenen van slijtage vertoont.

Lees deze instructies zorgvuldig door.

Het is belangrijk dat verzorgers instructies krijgen over handmatig tillen en verplaatsen. Etac biedt advies en training aan voor verzorgers. Neem voor meer informatie contact op met Etac.

Gebruik altijd de juiste technieken voor handmatig tillen en verplaatsen.

Moedig de gebruiker aan om waar mogelijk mee te helpen.

Bedenk altijd van tevoren hoe u een gebruiker handmatig gaat tillen en verplaatsen, zodat de gebruiker zich veilig voelt en elke handmatige handeling soepel verloopt.



Er bestaat een kans dat de gebruiker wegglijdt. Laat de gebruiker nooit alleen achter op de rand van het bed.



Laat het product nooit op de vloer liggen.



Voer altijd een risicoanalyse uit en verzeker u ervan dat het hulpmiddel geschikt is voor de individuele gebruiker en, bij gebruik in combinatie met andere hulpmiddelen, veilig is voor de gebruiker en de verzorgers.



Het wordt aangeraden om het bedhek omhoog te zetten als de gebruiker op het glijsysteem blijft liggen, tenzij uit de risicoanalyse is gebleken dat de gebruiker veilig op het glijsysteem kan blijven liggen zonder gebruik te maken van de bedhekken.



Zet het glijsysteem altijd vast nadat u de transfer hebt voltooid.

Neem bij twijfel contact op met Etac.

Materiaal en reiniging

Materiaal:

Polykatoen: 55% katoen/45% polyester

Satijn: Polyester.

Het product moet regelmatig worden gecontroleerd, bij voorkeur voor elk gebruik, en met name na het wassen.

Controleer op schade aan de naden en de stof.



**Probeer een product nooit zelf te repareren.
Gebruik een product nooit als het defect is.**



We adviseren om het product voor gebruik te wassen.

Wasinstructies:

Strijken verbetert het glijeffect.

Gebruik geen wasverzachter.

Dit product kan ook worden gereinigd met een reinigingsmiddel dat geen oplosmiddel bevat en een pH-waarde tussen 5 en 9 heeft. U kunt ook een ontsmettingsmiddel met een concentratie van 70% gebruiken.



Producten en accessoires

Artikelnr.	Productbeschrijving	Afmetingen (mm)
IM4116S	SatinSheet DrawSheet - mini	W2000xL1000
IM4118S	SatinSheet DrawSheet - midi	W2000xL1400

Set

Artikel-nr.	Beschrijving	SatinSheet 2Direction BaseSheet		SatinSheet DrawSheet en SatinSheet 4Direction	
IM4201S	SatinSheet DrawSheet mini set	IM4108S	SatinSheet 2Direction mini	IM4116S	SatinSheet DrawSheet - mini
IM4205S	SatinSheet DrawSheet midi small set	IM4119S	SatinSheet 2Direction midi small	IM4118S	SatinSheet DrawSheet - midi
IM4200S	SatinSheet DrawSheet midi set	IM4113S	SatinSheet 2Direction midi	IM4118S	SatinSheet DrawSheet - midi
IM4202S	SatinSheet DrawSheet maxi midi set	IM4114S	SatinSheet 2Direction maxi	IM4118S	SatinSheet DrawSheet - midi
IM4208S	SatinSheet Corner DrawSheet midi set	IM4107S	SatinSheet 2Direction w/elastic	IM4118S	SatinSheet DrawSheet - midi

ILL.

GB

SV

NO

DA

FI

DE

NL

FR

IT

ES

Combinaties

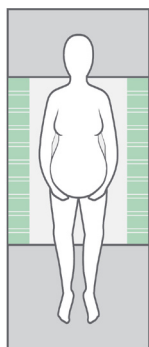

Article no. BaseSheet - Mini

IM4133S	SatinSheet 2Direction mini - small
IM4108S	SatinSheet 2Direction mini
IM4175S	SatinSheet 2Direction mini - wide
IM4178S	SatinSheet 2Direction mini - double

BaseSheet - Mini kan worden gecombineerd met:

Article no. DrawSheet and 4Direction

IM4116S	SatinSheet Drawsheet - mini
IM4110S	In2Sheet 4Direction w/wings - mini
IM4110SH	In2Sheet 4Direction w/wings + handles - mini

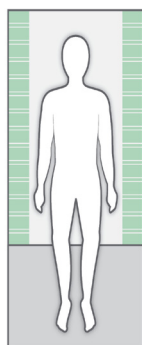

Article no. BaseSheet - Midi

IM4119S	SatinSheet 2Direction midi - small
IM4113S	SatinSheet 2Direction midi
IM4176S	SatinSheet 2Direction midi - wide
IM4179S	SatinSheet 2Direction midi - double
IM4157S	SatinSheet 2Direction Corner - midi satin

BaseSheet - Midi kan worden gecombineerd met:

Article no. DrawSheet and 4Direction and In2Sheet 4Direction

M4118S	SatinSheet Drawsheet - midi
IM4115S	SatinSheet 4Direction - midi
IM4115SH	SatinSheet 4Direction w/handles - midi
IM4140S	In2Sheet 4Direction w/wings - midi
IM4140SH	In2Sheet 4Direction w/wings + handles - midi

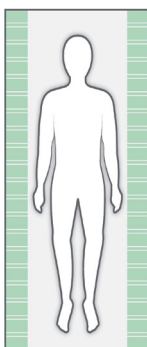

Article no. BaseSheet - Maxi

IM4181S	SatinSheet 2Direction maxi - small
IM4114S	SatinSheet 2Direction maxi
IM4177S	SatinSheet 2Direction maxi - wide
IM4180S	SatinSheet 2Direction maxi - double
IM4122S	SatinSheet 2Direction 180 cm bed

Article no. BaseSheet - Maxi Corner

IM4107S	SatinSheet 2Direction Corner
IM4147S	SatinSheet 2Direction Corner - wide
IM4137S	SatinSheet 2Direction Corner - double

Article no. BaseSheet - Maxi Fit

IM4112S	SatinSheet 2Direction Fit
IM4142S	SatinSheet 2Direction Elastic Fit

BaseSheet - Maxi/Corner/Fit kan worden gecombineerd met:

Article no. 4Direction and In2Sheet 4Direction

M4115S	SatinSheet 4Direction - midi
IM4115SH	SatinSheet 4Direction w/handles - midi
IM4140S	In2Sheet 4Direction w/wings - midi
IM4140SH	In2Sheet 4Direction - w/wings + handles - midi
IM4121S	SatinSheet 4Direction - maxi
IM4121SH	SatinSheet 4Direction w/handles - maxi

Denk ook aan een SatinSheet PillowCase (2D)

IM4117S	SatinSheet 2Direction PillowCase
---------	----------------------------------

Inspectie

Eerste inspectie:

- Is de verpakking onbeschadigd?
- Lees het label op de verpakking en controleer het artikelnummer en de productbeschrijving.
- Controleer of de beknopte handleiding is bijgevoegd. Nieuwe versies van de gebruikershandleiding/gebruiksaanwijzing kunt u downloaden via www.etac.com of opvragen bij de klantenservice van Etac of bij de distributeur in uw regio.
- Controleer of het label op het product de volgende informatie vermeldt: artikelnummer, productbeschrijving, partij-/batchnummer, reinigingsinstructies en naam van de leverancier.

Periodieke inspectie:

- Zorg dat uw systeem voor handmatige transfers altijd in perfecte staat verkeert.
- Controleer na het wassen altijd de materialen, het stikwerk, de handvatten en de gespen.
- Stel het product meteen buiten gebruik als het tekenen van slijtage vertoont.



Visuele inspectie/controleer het product:

Verzekert u ervan dat alle materialen, naden, stikwerk, handvatten en gespen onbeschadigd/vrij van defecten zijn.



Stabiliteitstest:

Probeer het product te verbuigen en verzekert u ervan dat het stevig, stabiel en solide aanvoelt.



Mechanische belasting of spanning/handvatten testen:

Trek hard aan de handvatten in tegenovergestelde richtingen en controleer het materiaal, de naden en het stikwerk.

Gespen testen:

Zet de gesp vast en trek in tegenovergestelde richtingen; controleer de gesp en het stikwerk.



Hoge/lage wrijving testen:

Plaats het product op een stevige ondergrond of een bed, plaats uw handen op het materiaal en test de wrijving door uw handen in het product omlaag te drukken.
Lage wrijving: glijden gaat moeiteloos
Hoge wrijving: glijden/verplaatsen gaat niet

Controleren:

Handmatige transferhulpmiddelen met handvatten, banden en gespen



Handmatige transferhulpmiddelen voor zittende en liggende transfers met hoge of lage wrijving:



Productiejaar, -maand en -dag



Het product kan worden afgevoerd volgens de nationale voorschriften



Lees de gebruikershandleiding

Généralités

Nous vous remercions d'avoir choisi un produit Etac.

Veillez lire attentivement ce manuel afin d'éviter les accidents et les blessures lors du déplacement et de la manipulation des produits.

La personne décrite comme « l'utilisateur » dans ce manuel est la personne couchée ou assise sur le produit. Les assistants sont les personnes qui manœuvrent le produit.



Ce symbole apparaît à côté du texte dans le manuel. Il attire l'attention du lecteur sur les points pouvant constituer un risque pour la santé et la sécurité de l'utilisateur ou d'un assistant.

Les produits sont conformes aux normes applicables pour les produits de Classe 1 selon la règlement relatif aux dispositifs médicaux (EU) 2017/745 relative aux dispositifs médicaux.

Etac s'efforce constamment d'améliorer ses produits et se réserve donc le droit d'apporter des modifications à ses produits sans préavis. Toutes les mesures indiquées sur les illustrations et tout matériel similaire sont à titre indicatif seulement et Etac ne peut être tenu responsable des erreurs ou des défauts.

Les informations contenues dans ce manuel, y compris les

recommandations, combinaisons et tailles, ne s'appliquent pas aux commandes spéciales et aux modifications. Si le client effectue/utilise des réglages, des réparations ou des combinaisons qui ne sont pas prédéterminés par Etac, la certification CE d'Etac et la garantie d'Etac seront annulées. En cas de doute, veuillez contacter Etac.

Garantie : garantie de deux ans sur les matériaux et les défauts de fabrication, à condition que le produit soit utilisé correctement.

Durée de vie prévue : La durée de vie de cet appareil est d'un à deux ans dans des conditions normales d'utilisation. Sa durée de vie dépend de la fréquence d'utilisation, des charges ainsi que du nombre de lavage.

Pour de plus amples informations sur la gamme de transfert Etac, consultez www.etac.com.

En cas d'événement indésirable lié à l'appareil, signalez tout incident à votre revendeur local et aux autorités nationales compétentes dans les meilleurs délais. Le revendeur local transmettra les informations au fabricant.

Symboles en général



Lavage



Niveau de pH / Essuyer



Avertissement



Fabricant



Ne pas javelliser



Ne jamais laisser sur le sol



Jour, mois et année de fabrication



Certification CE



Séchage en machine



Risque de glissement vers le bas



Batch no./N° de lot



Garder au sec



Repassage



Tenir à l'abri du soleil



Poids max. de l'utilisateur = charge nominale maximale



Non stérile



Ne pas nettoyer à sec



Lire le manuel de l'utilisateur



Le produit peut être mis au rebut conformément à la réglementation nationale



Référence nationale



Dispositifs médicaux

Usage prévu

Les draps DrawSheet doivent toujours être utilisés avec un produit SatinSheet.

Les modèles de drap DrawSheet IM4116S et IM4118S sont deux draps DrawSheet différents à utiliser avec un drap de BaseSheet (SatinSheet). Le drap DrawSheet peut être utilisé lors de la manipulation manuelle d'un côté à un autre. SatinSheet 4Direction peut être utilisé pour la manipulation

manuelle d'un côté à un autre, et vers le haut et le bas dans le lit. La gamme SatinSheet comprend différents modèles de drap BaseSheet avec un matériau à faibles frottements et des draps DrawSheet. Le choix de modèle ou de combinaison est fait en fonction des fonctions et des besoins de l'utilisateur et de l'environnement de travail des soignants.

Environnement prévu

Soins de courte durée, soins de longue durée, soins à domicile

Manipulation

Positionnement

Positionnez SatinSheet 2Direction avec le matériau à faibles frottements orienté vers le haut dans le milieu du lit (Illustrations). Posez le drap DrawSheet sur SatinSheet 2Direction. Tous les modèles SatinSheet disposent d'une étiquette « ce côté vers

le haut », afin d'assurer que le bon côté soit placé correctement dans le lit. Une étiquette d'informations, décrivant l'utilisation correcte du produit, est cousue dans tous les modèles/produits SatinSheet.

Utilisation

Si l'utilisateur a besoin d'aide pour tourner, SatinSheet est idéal lorsqu'il est utilisé avec un drap DrawSheet.

Le drap de tirage aide l'utilisateur à tourner d'un côté à l'autre dans le lit.

Un drap SatinSheet 2Direction peut être utilisé pour aider l'utilisateur à se lever ou se coucher dans le lit et se déplacer d'un côté à l'autre (Illustration 1).

Tourner se fait en saisissant le drap au niveau des hanches et des épaules de l'utilisateur. Pour obtenir une meilleure saisie ergonomique, le soignant doit saisir autant de tissu que possible.

Travaillez toujours avec les poignets plats et servez-vous du transfert de poids.

Deux soignants peuvent également tourner avec SatinSheet. Les soignants travaillent ensemble. Un soignant tire sur le drap DrawSheet tandis que l'autre tire le matelas vers le bas au niveau des hanches et des épaules de l'utilisateur, en poussant doucement.

Tournez l'utilisateur (illustration 2). Pour verrouiller le système de glissement après avoir tourné : pliez le tissu du drap DrawSheet en trop sous le matelas des deux côtés du lit. Avant de verrouiller le système de glissement sous le matelas, il convient de tendre les plis/irrégularités pour éviter les cas de décubitus. Les soignants tirent simultanément et en diagonale des deux côtés.

Notice

Fonctions spéciales

Vérifiez toujours le produit avant toute utilisation et après tout lavage.

N'utilisez jamais un produit défectueux. Si le produit présente des signes d'usure, il doit être mis au rebut.

Lisez attentivement ces instructions.

Il est important que les soignants reçoivent une formation à la manipulation du produit. Etac propose des conseils et des formations à destination des soignants. Pour plus d'informations, contactez Etac.

Utilisez toujours de bonnes techniques de manipulation manuelle.

Encouragez l'utilisateur à aider autant que possible.

Pour que l'utilisateur se sente en sécurité et que chaque manipulation manuelle se passe bien, planifiez toujours la manipulation à l'avance.



Il existe un risque de glissement de l'utilisateur. Ne laissez jamais l'utilisateur seul au bord du lit.



Ne laissez jamais le produit sur le sol.



Effectuez toujours une évaluation des risques et assurez-vous que le produit d'assistance convient à l'utilisateur et peut être utilisé en combinaison avec d'autres dispositifs d'une manière ne présentant aucun danger pour l'utilisateur et les soignants.



Il est recommandé que le rail de protection soit en place lorsque l'utilisateur est laissé sur le système de glissement, à moins qu'une évaluation des risques n'ait déterminé que l'utilisateur peut en toute sécurité être laissé sur le système de glissement sans que des rails de protection soient nécessaires.



Verrouillez toujours le système de glissement lorsque vous avez terminé le transfert.

En cas de doute - veuillez contacter Etac.

Matériau et nettoyage

Matériau :

Polycoton : 55 % coton / 45 % polyester
Satin : Polyester.

Le produit doit être vérifié régulièrement, de préférence chaque fois qu'il est utilisé, et surtout après un lavage.

Vérifiez qu'il n'y a aucun dommage au niveau des coutures ou du tissu.



**N'essayez jamais de réparer un produit vous-même.
N'utilisez jamais un produit défectueux.**



Lavage du produit recommandé avant utilisation.

Instructions de lavage :

Repasser améliore l'effet de glisse.
N'utilisez pas d'adoucissant.

Le produit peut être nettoyé avec un agent nettoyant sans solvant, de pH compris entre 5 et 9, ou une solution désinfectante diluée à 70 %.



Produits et accessoires

N° d'article	Description	Dimensions (mm)
IM4116S	SatinSheet DrawSheet - mini	W2000xL1000
IM4118S	SatinSheet DrawSheet - midi	W2000xL1400

Kit

N° d'article	Description	SatinSheet 2Direction BaseSheet		SatinSheet DrawSheet et SatinSheet 4Direction	
IM4201S	SatinSheet DrawSheet mini set	IM4108S	SatinSheet 2Direction mini	IM4116S	SatinSheet DrawSheet - mini
IM4205S	SatinSheet DrawSheet midi small set	IM4119S	SatinSheet 2Direction midi small	IM4118S	SatinSheet DrawSheet - midi
IM4200S	SatinSheet DrawSheet midi set	IM4113S	SatinSheet 2Direction midi	IM4118S	SatinSheet DrawSheet - midi
IM4202S	SatinSheet DrawSheet maxi midi set	IM4114S	SatinSheet 2Direction maxi	IM4118S	SatinSheet DrawSheet - midi
IM4208S	SatinSheet Corner DrawSheet midi set	IM4107S	SatinSheet 2Direction w/elastic	IM4118S	SatinSheet DrawSheet - midi

ILL.

GB

SV

NO

DA

FI

DE

NL

FR

IT

ES

Combinaisons

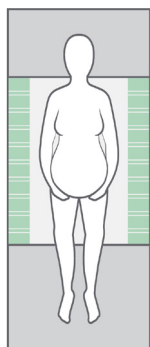

Article no. BaseSheet - Mini

IM4133S	SatinSheet 2Direction mini - small
IM4108S	SatinSheet 2Direction mini
IM4175S	SatinSheet 2Direction mini - wide
IM4178S	SatinSheet 2Direction mini - double

BaseSheet - Mini peut être associé à :

Article no. DrawSheet and 4Direction

IM4116S	SatinSheet Drawsheet - mini
IM4110S	In2Sheet 4Direction w/wings - mini
IM4110SH	In2Sheet 4Direction w/wings + handles - mini

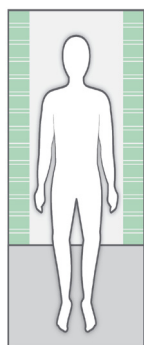

Article no. BaseSheet - Midi

IM4119S	SatinSheet 2Direction midi - small
IM4113S	SatinSheet 2Direction midi
IM4176S	SatinSheet 2Direction midi - wide
IM4179S	SatinSheet 2Direction midi - double
IM4157S	SatinSheet 2Direction Corner - midi satin

BaseSheet - Midi peut être associé à :

Article no. DrawSheet and 4Direction and In2Sheet 4Direction

M4118S	SatinSheet Drawsheet - midi
IM4115S	SatinSheet 4Direction - midi
IM4115SH	SatinSheet 4Direction w/handles - midi
IM4140S	In2Sheet 4Direction w/wings - midi
IM4140SH	In2Sheet 4Direction w/wings + handles - midi

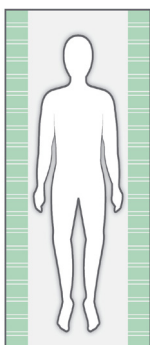

Article no. BaseSheet - Maxi

IM4181S	SatinSheet 2Direction maxi - small
IM4114S	SatinSheet 2Direction maxi
IM4177S	SatinSheet 2Direction maxi - wide
IM4180S	SatinSheet 2Direction maxi - double
IM4122S	SatinSheet 2Direction 180 cm bed

Article no. BaseSheet - Maxi Corner

IM4107S	SatinSheet 2Direction Corner
IM4147S	SatinSheet 2Direction Corner - wide
IM4137S	SatinSheet 2Direction Corner - double

Article no. BaseSheet - Maxi Fit

IM4112S	SatinSheet 2Direction Fit
IM4142S	SatinSheet 2Direction Elastic Fit

BaseSheet - Maxi/Corner/Fit peut être associé à :

Article no. 4Direction and In2Sheet 4Direction

M4115S	SatinSheet 4Direction - midi
IM4115SH	SatinSheet 4Direction w/handles - midi
IM4140S	In2Sheet 4Direction w/wings - midi
IM4140SH	In2Sheet 4Direction - w/wings + handles - midi
IM4121S	SatinSheet 4Direction - maxi
IM4121SH	SatinSheet 4Direction w/handles - maxi

Souvenez-vous de SatinSheet PillowCase (2D)

IM4117S	SatinSheet 2Direction PillowCase
---------	----------------------------------

Inspection

Première inspection :

- L'emballage est-il intact ?
- Lisez l'étiquette sur l'emballage et vérifiez le numéro d'article et la description du produit.
- Vérifiez que les instructions sommaires accompagnent le produit - vous pouvez télécharger un Manuel de l'utilisateur/Mode d'emploi mis à jour depuis le site www.etac.com ou l'obtenir en contactant le service client d'Etac ou le distributeur local.
- Vérifiez l'étiquette sur le produit - comporte-t-elle un n° d'article, une description du produit, un n° de lot/batch no, des instructions de nettoyage et le nom du fournisseur ?

Inspection périodique :

- Assurez-vous que votre système de transfert manuel est toujours en parfait état.
- Après un lavage - vérifiez toujours les matériaux, surpiqûres, poignées et boucles.
- Si le produit présente des signes d'usure, il doit être retiré du service immédiatement.



Inspection visuelle/Vérification du produit :

Veillez à ce que les matériaux, les coutures, les surpiqûres, les poignées et les boucles soient intacts/sans défaut.



Test de stabilité :

Essayez de plier le produit et vérifiez qu'il semble ferme, stable et solide.



Charge ou contrainte mécanique/

Test des poignées :

Tirez fortement les poignées dans des directions opposées et contrôlez les matériaux, les coutures et les surpiqûres.

Test des boucles :

Fermez la boucle et tirez dans des directions opposées. Contrôlez la boucle et les surpiqûres.



Test de friction basse/élevée :

Placez le produit sur une surface ferme ou un lit, placez vos mains sur le matériau et tester la friction en poussant avec les mains sur le produit.

Friction basse - vos mains glissent sans effort

Friction élevée - vos mains ne glissent pas/ ne bougent pas

Vérification::

Aides au transfert manuelles avec poignées, sangles et boucles



Aides au transfert manuelles pour positions assise et couchée avec friction basse ou élevée:



Jour, mois et année de fabrication



Le produit peut être mis au rebut conformément à la réglementation nationale.



Lire le manuel de l'utilisateur

Informazioni generali

Grazie per aver scelto un prodotto Etac.

Per evitare incidenti e lesioni durante lo spostamento e la movimentazione dei prodotti, leggere attentamente il manuale.

Nel presente manuale, il soggetto descritto come "l'utente" è la persona seduta o sdraiata sul prodotto, Gli assistenti sono coloro che manovrano il prodotto.



Questo simbolo è presente lungo le pagine del manuale. Richiama l'attenzione del lettore su punti che possono comportare rischi per la salute e la sicurezza dell'utente o dell'assistente.

I prodotti sono conformi alle norme applicabili per i prodotti di Classe 1 contenute nella Regolamento sui dispositivi medici (EU) 2017/745 sui dispositivi medici.

In Etac ci sforziamo di migliorare continuamente i nostri prodotti; pertanto, ci riserviamo il diritto di modificare i prodotti senza preavviso. Tutte le misurazioni riportate nelle figure o in altro materiale informativo sono puramente indicative: Etac non può essere ritenuta responsabile di eventuali errori e difetti.

Le informazioni riportate nel presente manuale, ivi compresi

raccomandazioni, combinazioni e dati dimensionali, non sono applicabili a ordini e modifiche speciali. Qualora il cliente effettui regolazioni, riparazioni o combinazioni non autorizzate da Etac, la certificazione CE di Etac e la garanzia di Etac decadono. In caso di dubbi, contattare Etac.

Garanzia: garanzia di due anni per difetti di materiali e di fabbricazione, purché il prodotto sia stato utilizzato correttamente.

Durata prevista: La durata utile prevista del dispositivo, in normali condizioni d'uso, è compresa tra 1 e 2 anni. La durata utile del dispositivo varia in base alla frequenza d'uso, i carichi e la frequenza e modalità di lavaggio.

Per maggiori informazioni sulla gamma di dispositivi di trasferimento Etac, visitare il sito www.etac.com.

In caso di evento avverso verificatosi in relazione al dispositivo, gli incidenti devono essere segnalati tempestivamente al rivenditore locale e all'autorità nazionale competente. Il rivenditore locale inoltrerà le informazioni al produttore.

Panoramica dei simboli



Lavaggio



Livello di pH / Pulire con un panno



Attenzione



Produttore



Non candeggiare



Non lasciare sul pavimento



Giorno, mese e anno di produzione



Certificazione CE



Asciugatura a tamburo a temperatura moderata



Rischio di scivolamento



N. di serie/lotto



Mantenere asciutto



Stiratura



Non esporre ai raggi solari



Limite massa utente = carico nominale massimo



Non sterile



Non lavare a secco



Leggere il manuale dell'utente



Smaltire il prodotto in conformità con le normative nazionali vigenti



Numero articolo



Dispositivo medico

Uso previsto

Utilizzare sempre i dispositivi DrawSheet in combinazione con un prodotto SatinSheet.

I modelli DrawSheet IM4116S e IM4118S sono diversi e possono essere utilizzati insieme a BaseSheet (SatinSheet).

DrawSheet può essere utilizzato nella movimentazione manuale necessaria per passare da un lato all'altro. SatinSheet 4Direction può essere utilizzato per la movimentazione manuale

necessaria per passare da un lato all'altro e per salire e scendere dal letto. La gamma SatinSheet comprende diversi modelli di BaseSheet con materiale a basso attrito e DrawSheet. La scelta del modello o della combinazione è operata in base alle funzioni e alle esigenze dell'utente, nonché all'ambiente di lavoro degli assistenti.

Ambiente previsto

Assistenza di pazienti gravi, assistenza a lungo termine, assistenza domiciliare

Movimentazione pratica

Posizionamento

Posizionare SatinSheet 2Direction con il materiale a basso attrito rivolto verso l'alto al centro del letto (v. figure).
Posizionare DrawSheet su SatinSheet 2Direction. Tutti i modelli SatinSheet sono dotati di un'etichetta "Questo lato rivolto verso

l'alto" per garantire che, nel letto, il lato corretto sia rivolto verso l'alto. Un'etichetta informativa che descrive l'uso corretto del prodotto è cucita su tutti i modelli/prodotti SatinSheet.

Uso

Se l'utente ha bisogno di aiuto per girarsi, SatinSheet è ideale se utilizzato insieme a DrawSheet.
La traversa aiuta l'utente a spostarsi da un lato all'altro del letto. SatinSheet 2Direction può essere utilizzato per aiutare a far salire o scendere l'utente dal letto e a passare da un lato all'altro (fig. 1).

L'utente viene girato afferrando il lenzuolo all'altezza dei fianchi e delle spalle dello stesso. Per ottenere una presa ergonomica più salda, l'assistente dovrebbe afferrare quanto più tessuto possibile.

Lavorare sempre con i polsi piatti e spostando il peso.

La rotazione con SatinSheet può essere eseguita anche da due assistenti che lavorano insieme. Un assistente aiuta a tirare DrawSheet, mentre l'altro preme sul materasso all'altezza dei fianchi e delle spalle dell'utente, spingendolo delicatamente.

Girare l'utente (fig. 2). Per bloccare il sistema di movimentazione scorrevole dopo aver girato l'utente: ripiegare il materiale in eccesso di DrawSheet sotto il materasso, su entrambi i lati del letto.

Prima di bloccare il sistema di movimentazione scorrevole sotto il materasso, lasciare eventuali stropicciamenti/pieghe per evitare la formazione di piaghe da decubito. Gli assistenti tirano contemporaneamente e trasversalmente da entrambi i lati.

ILL.

GB

SV

NO

DA

FI

DE

NL

FR

IT

ES

Avviso

Caratteristiche speciali

Controllare sempre il prodotto prima dell'uso e dopo il lavaggio.

Non utilizzare mai un prodotto difettoso. Smaltire il prodotto se questo presenta segni di usura.

Leggere attentamente le presenti istruzioni.

È importante che gli assistenti ricevano adeguate istruzioni sulla movimentazione manuale. Etac offre consulenza e formazione agli assistenti. Per maggiori informazioni, contattare Etac.

Utilizzare sempre le corrette tecniche di movimentazione manuale.

Se possibile, sollecitare l'utente a collaborare.

Per garantire che l'utente si senta sicuro e che ogni movimento sia fluido, pianificare sempre la movimentazione manuale in anticipo.



L'utente potrebbe scivolare. Non lasciare mai l'utente da solo sul bordo del letto.



Non lasciare mai il prodotto sul pavimento.



Eseguire sempre una valutazione dei rischi e accertarsi che il prodotto assistivo possa essere utilizzato per il singolo utente e che, in combinazione con altri dispositivi, sia sicuro per l'utente e gli assistenti.



Quando l'utente viene lasciato sul sistema di movimentazione scorrevole, è consigliabile installare la barriera di protezione, a meno che, in base a una valutazione dei rischi, non risulti possibile lasciare l'utente in sicurezza sul sistema senza barre di protezione.



A trasferimento ultimato, bloccare sempre il sistema di movimentazione scorrevole.

In caso di dubbi, contattare Etac.

Materiali e pulizia

Materiale:

Policotone: 55% cotone/45% poliestere

Raso: Poliestere.

Controllare il prodotto regolarmente, preferibilmente ogni volta che viene utilizzato e in particolare dopo il lavaggio.

Controllare che non vi siano lacerazioni alle cuciture o al tessuto.



**Non tentare mai di riparare un prodotto da soli.
Non utilizzare mai un prodotto difettoso.**



Si consiglia di lavare il prodotto prima dell'uso.

Istruzioni di lavaggio:

La stiratura migliora l'effetto di scorrimento.

Non usare ammorbidente.

Lavare il prodotto utilizzando un detergente privo di solventi con pH compreso tra 5 e 9 oppure una soluzione disinfettante al 70%.



Prodotti e accessori

Articolo n.	Descrizione prodotto	Dimensioni (mm)
IM4116S	SatinSheet DrawSheet - mini	W2000xL1000
IM4118S	SatinSheet DrawSheet - midi	W2000xL1400

Set

Articolo n.	Descrizione	SatinSheet 2Direction BaseSheet		SatinSheet DrawSheet e SatinSheet 4Direction	
		Articolo n.	Descrizione	Articolo n.	Descrizione
IM4201S	SatinSheet DrawSheet mini set	IM4108S	SatinSheet 2Direction mini	IM4116S	SatinSheet DrawSheet - mini
IM4205S	SatinSheet DrawSheet midi small set	IM4119S	SatinSheet 2Direction midi small	IM4118S	SatinSheet DrawSheet - midi
IM4200S	SatinSheet DrawSheet midi set	IM4113S	SatinSheet 2Direction midi	IM4118S	SatinSheet DrawSheet - midi
IM4202S	SatinSheet DrawSheet maxi midi set	IM4114S	SatinSheet 2Direction maxi	IM4118S	SatinSheet DrawSheet - midi
IM4208S	SatinSheet Corner DrawSheet midi set	IM4107S	SatinSheet 2Direction w/elastic	IM4118S	SatinSheet DrawSheet - midi

ILL.

GB

SV

NO

DA

FI

DE

NL

FR

IT

ES

Combinazioni

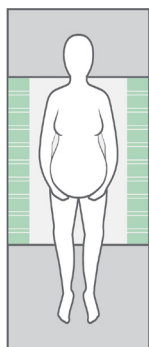

Article no.	BaseSheet - Mini
IM4133S	SatinSheet 2Direction mini - small
IM4108S	SatinSheet 2Direction mini
IM4175S	SatinSheet 2Direction mini - wide
IM4178S	SatinSheet 2Direction mini - double

BaseSheet - Mini può essere combinato con:

Article no.	DrawSheet and 4Direction
IM4116S	SatinSheet Drawsheet - mini
IM4110S	In2Sheet 4Direction w/wings - mini
IM4110SH	In2Sheet 4Direction w/wings + handles - mini

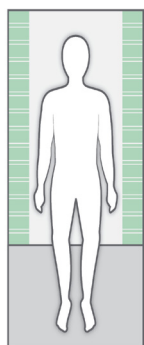

Article no.	BaseSheet - Midi
IM4119S	SatinSheet 2Direction midi - small
IM4113S	SatinSheet 2Direction midi
IM4176S	SatinSheet 2Direction midi - wide
IM4179S	SatinSheet 2Direction midi - double
IM4157S	SatinSheet 2Direction Corner - midi satin

BaseSheet - Midi può essere combinato con:

Article no.	DrawSheet and 4Direction and In2Sheet 4Direction
M4118S	SatinSheet Drawsheet - midi
IM4115S	SatinSheet 4Direction - midi
IM4115SH	SatinSheet 4Direction w/handles - midi
IM4140S	In2Sheet 4Direction w/wings - midi
IM4140SH	In2Sheet 4Direction w/wings + handles - midi

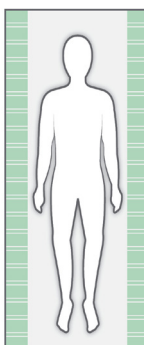

Article no.	BaseSheet - Maxi
IM4181S	SatinSheet 2Direction maxi - small
IM4114S	SatinSheet 2Direction maxi
IM4177S	SatinSheet 2Direction maxi - wide
IM4180S	SatinSheet 2Direction maxi - double
IM4122S	SatinSheet 2Direction 180 cm bed

Article no.	BaseSheet - Maxi Corner
IM4107S	SatinSheet 2Direction Corner
IM4147S	SatinSheet 2Direction Corner - wide
IM4137S	SatinSheet 2Direction Corner - double

Article no.	BaseSheet - Maxi Fit
IM4112S	SatinSheet 2Direction Fit
IM4142S	SatinSheet 2Direction Elastic Fit

BaseSheet - Maxi/Corner/Fit può essere combinato con:

Article no.	4Direction and In2Sheet 4Direction
M4115S	SatinSheet 4Direction - midi
IM4115SH	SatinSheet 4Direction w/handles - midi
IM4140S	In2Sheet 4Direction w/wings - midi
IM4140SH	In2Sheet 4Direction - w/wings + handles - midi
IM4121S	SatinSheet 4Direction - maxi
IM4121SH	SatinSheet 4Direction w/handles - maxi

Ricordarsi di utilizzare SatinSheet PillowCase (2D)

IM4117S	SatinSheet 2Direction PillowCase
---------	----------------------------------

Ispezione

Prima ispezione:

- La confezione è intatta?
- Leggere l'etichetta sulla confezione e controllare il numero dell'articolo e la descrizione del prodotto.
- Verificare che il foglio di istruzioni sia presente nella confezione. È possibile scaricare la versione aggiornata del manuale dell'utente/delle istruzioni per l'uso dal sito www.etac.com oppure contattare il servizio clienti Etac o il proprio rivenditore locale.
- Controllare l'etichetta sul prodotto: riporta il numero dell'articolo, la descrizione del prodotto, il numero di serie/lotto, le istruzioni per la pulizia e il nome del fornitore?

Ispezione periodica:

- Assicurarsi che il sistema di trasferimento manuale sia sempre in perfette condizioni.
- Dopo il lavaggio, verificare sempre lo stato di materiali, cuciture, impugnature e fibbie.
- Se il prodotto presenta segni di usura, dismetterlo immediatamente.



Ispezione visiva/controllo del prodotto:

Assicurarsi che i materiali, le cuciture, le impunture, le impugnature e le fibbie siano intatti/privi di difetti.



Test di stabilità:

Provare a piegare il prodotto e verificare che sia robusto, stabile e resistente.

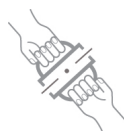

Carico o sollecitazioni di tipo meccanico/

Test sulle impugnature:

Tirare con forza le impugnature in direzioni opposte; quindi, controllare il materiale, le cuciture e le impunture.

Test sulle fibbie:

Bloccare la fibbia e tirare in direzioni opposte; quindi, controllare la fibbia e le cuciture.



Test di attrito basso/elevato:

Posizionare il dispositivo su una superficie resistente o un letto, poggiare le mani sul materiale e testarne l'attrito spingendo sul prodotto.

Attrito basso: scorre senza sforzo

Attrito elevato: non scorre/non si muove

Controlli da effettuare:

Ausili per il trasferimento manuale con impugnature, cinghie e fibbie:

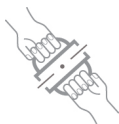

Ausili per il trasferimento manuale di utenti seduti e sdraiati con attrito basso o elevato:



Giorno, mese e anno di produzione



Smaltire il prodotto in conformità con le normative nazionali vigenti



Leggere il manuale dell'utente

Información general

Gracias por elegir un producto Etac.

Para evitar cualquier tipo de accidente o lesión cuando mueva y maneje los productos, lea atentamente el manual.

La persona descrita como el «usuario» se referirá, en estas Instrucciones de uso, a la persona que está tumbada o sentada sobre el producto. Los cuidadores son las personas que manipulan el producto.



Este símbolo aparecerá al lado del texto en el manual. Le indica al lector aquellos puntos en los que puede existir un riesgo para la salud y la seguridad del usuario o del cuidador.

Los productos cumplen con la normativa aplicable para productos de la Clase 1, de la Regulación de productos sanitarios (EU) 2017/745 relativa a los dispositivos médicos.

En Etac, hacemos todo lo posible por mejorar constantemente nuestros productos y, por ese motivo, nos reservamos el derecho a modificar los productos sin previo aviso. Las medidas que se indican en las imágenes y en material similar se incluyen solo a modo de guía y Etac queda exenta de cualquier tipo de responsabilidad por errores y defectos.

La información incluida en este manual, incluidas las

recomendaciones, las combinaciones y los tamaños, no resulta de aplicación para los pedidos especiales ni para las modificaciones. Si el cliente efectúa ajustes, reparaciones o combinaciones que no están previstas por Etac, la certificación Etac CE y la garantía de Etac serán nulas de pleno derecho. En caso de duda, póngase en contacto con Etac.

Garantía: garantía de dos años por defectos del material y de fabricación, siempre y cuando el producto se haya utilizado correctamente.

Vida útil prevista: El producto tiene una vida útil prevista de 1 a 2 años en condiciones de uso normales. La vida útil del producto dependerá de la frecuencia de uso, de las cargas y de la frecuencia con la que se lave.

Para más información sobre la gama de productos de movilización de usuarios de Etac, consulte www.etac.com.

En caso de que se produzca un acontecimiento adverso en relación con el dispositivo, deberá informar de la incidencia, a su debido tiempo, a su distribuidor local y a la autoridad competente nacional. El distribuidor local enviará la información al fabricante.

Símbolos generales



Lavado



Nivel pH / Pasar un paño



Cuidado



Fabricante



No utilizar lejía



No dejar nunca en el suelo



Año, mes y día de producción
YYYY-MM-DD



Certificación CE



Secar en secadora



Riesgo de resbalar



N.º de lote



Mantener seco



Planchar



Manténgase alejado de la luz del sol



Peso máximo del usuario = carga nominal máxima
max 150 kg / max 330 lbs



No estéril



No limpiar en seco



Leer el manual de usuario



El producto se puede desechar de conformidad con la normativa nacional



Número de artículo



Uso previsto

Las sábanas DrawSheet deberían utilizarse siempre junto con un producto SatinSheet.

Los modelos DrawSheet IM4116S e IM4118S son dos sábanas DrawSheet distintas que pueden utilizarse con BaseSheet (SatinSheet). DrawSheet puede usarse para la movilización manual de un lado a otro. SatinSheet 4Direction puede usarse

para la movilización manual de un lado a otro, y para subir y bajar al usuario en la cama. La gama SatinSheet incluye distintos modelos de BaseSheet con material de baja fricción y DrawSheets. La elección del modelo o de la combinación se realiza según las funciones y necesidades del usuario y del entorno de trabajo del cuidador.

Entorno de uso previsto

Cuidados intensivos, cuidados de larga duración, cuidados

Modo de uso

Colocación

Coloque SatinSheet 2Direction con el material de baja fricción mirando hacia arriba en el centro de la cama (vea las imágenes). Coloque DrawSheet sobre SatinSheet 2Direction. Todos los modelos de SatinSheet tienen una etiqueta con la inscripción «this side up» (este lado hacia arriba) para, para ayudarle a

asegurarse de que el lado correcto está colocado hacia arriba sobre la cama. Todos los modelos/productos SatinSheet tienen cosida una etiqueta informativa en la que se describe el uso correcto del producto.

Uso

Si el usuario necesita ayuda para girarse, SatinSheet es ideal cuando se utiliza con DrawSheet. La sábana de arrastre ayuda al usuario a girar de un lado a otro en la cama. Se puede utilizar SatinSheet 2Direction para ayudar a subir y bajar al usuario en la cama y moverlo de un lado a otro (imagen 1).

Para girarlo, es preciso agarrar la sábana a la altura de las caderas y los hombros del usuario. Con el fin de obtener un agarre más ergonómico, el cuidador debería agarrar la mayor cantidad de tela posible. Trabaje siempre con las muñecas planas y el traslado del peso.

También es posible girar a un usuario con SatinSheet con la participación de dos cuidadores. Los cuidadores trabajan juntos. Uno de los cuidadores ayuda a tirar de DrawSheet mientras el otro la coloca sobre el colchón a la altura de las caderas y los hombros del usuario, presionando suavemente.

Gire al usuario (imagen 2). Para fijar el sistema deslizante después de girarlo: pliegue el material que sobresale de DrawSheet debajo del colchón por ambos lados de la cama. Antes de fijar el sistema deslizante debajo del colchón, deberá alisar cualquier irregularidad/arruga para evitar las úlceras de decúbito. Los cuidadores tiran a la vez y en diagonal de ambos lados.

Aviso

Características especiales

Verifique siempre el producto antes de usarlo y después de lavarlo.

No utilice nunca un producto defectuoso. Si el producto presenta signos de desgaste o rotura, debe desecharse.

Lea estas instrucciones cuidadosamente.

Es importante que los cuidadores reciban formación para la movilización manual. Etac ofrece información y formación para cuidadores. Para más información, póngase en contacto con Etac.

Utilice siempre las técnicas de movilización manual correctas.

Anime al usuario a ayudar cuando le resulte posible.

Para asegurarse de que el usuario se siente seguro y que cada movilización manual se hace de manera suave, planifique siempre con antelación la movilización manual.



Existe un riesgo de que el usuario se resbale. No deje nunca al usuario solo en el borde de la cama.



No deje nunca el producto en el suelo.



Lleve a cabo siempre una evaluación de los riesgos, y asegúrese de que el producto asistencial puede utilizarse con el usuario concreto y combinado con otros dispositivos que sean seguros tanto para el usuario como para los cuidadores.



Se recomienda dejar puesta la barandilla protectora cuando se deje al usuario sobre el sistema deslizante, a menos que, después de evaluar los riesgos, se haya determinado que se puede dejar al usuario con total seguridad en él sin necesidad de barandillas.



Fije siempre el sistema deslizante cuando haya terminado la movilización.

En caso de cualquier duda, póngase en contacto con Etac.

Material y limpieza

Material:

Polialgodón: 55 % algodón / 45 % poliéster
Raso: Poliéster.

El producto debería revisarse con regularidad, preferentemente cada vez que se use sobre todo después de haberlo lavado.

Compruebe que las costuras o el tejido no estén dañados.



**No intente reparar usted mismo el producto.
No utilice nunca un producto defectuoso.**



Se recomienda lavar el producto antes de usarlo.

Instrucciones de lavado:

El planchado mejora el efecto deslizante.
No utilizar suavizante.

El producto se puede limpiar con un agente limpiador sin disolventes con un nivel de pH entre 5-9, o una solución de desinfección al 70 %.



Productos y accesorios

Nº del artículo	Descripción del producto	Tamaño (mm)
IM4116S	SatinSheet DrawSheet - mini	W2000xL1000
IM4118S	SatinSheet DrawSheet - midi	W2000xL1400

Set

Nº del artículo	Descripción	SatinSheet 2Direction BaseSheet		SatinSheet DrawSheet y SatinSheet 4Direction	
IM4201S	SatinSheet DrawSheet mini set	IM4108S	SatinSheet 2Direction mini	IM4116S	SatinSheet DrawSheet - mini
IM4205S	SatinSheet DrawSheet midi small set	IM4119S	SatinSheet 2Direction midi small	IM4118S	SatinSheet DrawSheet - midi
IM4200S	SatinSheet DrawSheet midi set	IM4113S	SatinSheet 2Direction midi	IM4118S	SatinSheet DrawSheet - midi
IM4202S	SatinSheet DrawSheet maxi midi set	IM4114S	SatinSheet 2Direction maxi	IM4118S	SatinSheet DrawSheet - midi
IM4208S	SatinSheet Corner DrawSheet midi set	IM4107S	SatinSheet 2Direction w/elastic	IM4118S	SatinSheet DrawSheet - midi

ILL.

GB

SV

NO

DA

FI

DE

NL

FR

IT

ES

Combinaciones

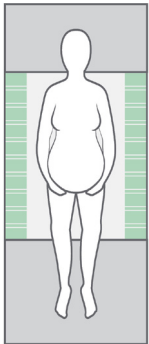

Article no.	BaseSheet - Mini
IM4133S	SatinSheet 2Direction mini - small
IM4108S	SatinSheet 2Direction mini
IM4175S	SatinSheet 2Direction mini - wide
IM4178S	SatinSheet 2Direction mini - double

BaseSheet - Mini puede combinarse con:

Article no.	DrawSheet and 4Direction
IM4116S	SatinSheet Drawsheet - mini
IM4110S	In2Sheet 4Direction w/wings - mini
IM4110SH	In2Sheet 4Direction w/wings + handles - mini

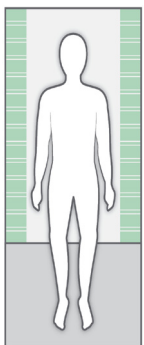

Article no.	BaseSheet - Midi
IM4119S	SatinSheet 2Direction midi - small
IM4113S	SatinSheet 2Direction midi
IM4176S	SatinSheet 2Direction midi - wide
IM4179S	SatinSheet 2Direction midi - double
IM4157S	SatinSheet 2Direction Corner - midi satin

BaseSheet - Midi puede combinarse con:

Article no.	DrawSheet and 4Direction and In2Sheet 4Direction
M4118S	SatinSheet Drawsheet - midi
IM4115S	SatinSheet 4Direction - midi
IM4115SH	SatinSheet 4Direction w/handles - midi
IM4140S	In2Sheet 4Direction w/wings - midi
IM4140SH	In2Sheet 4Direction w/wings + handles - midi

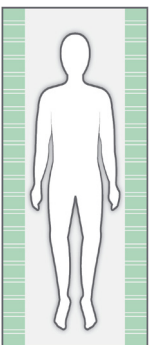

Article no.	BaseSheet - Maxi
IM4181S	SatinSheet 2Direction maxi - small
IM4114S	SatinSheet 2Direction maxi
IM4177S	SatinSheet 2Direction maxi - wide
IM4180S	SatinSheet 2Direction maxi - double
IM4122S	SatinSheet 2Direction 180 cm bed

Article no.	BaseSheet - Maxi Corner
IM4107S	SatinSheet 2Direction Corner
IM4147S	SatinSheet 2Direction Corner - wide
IM4137S	SatinSheet 2Direction Corner - double

Article no.	BaseSheet - Maxi Fit
IM4112S	SatinSheet 2Direction Fit
IM4142S	SatinSheet 2Direction Elastic Fit

BaseSheet - Maxi/Corner/Fit puede combinarse con:

Article no.	4Direction and In2Sheet 4Direction
M4115S	SatinSheet 4Direction - midi
IM4115SH	SatinSheet 4Direction w/handles - midi
IM4140S	In2Sheet 4Direction w/wings - midi
IM4140SH	In2Sheet 4Direction - w/wings + handles - midi
IM4121S	SatinSheet 4Direction - maxi
IM4121SH	SatinSheet 4Direction w/handles - maxi

Recuerde usar la SatinSheet PillowCase (2D)

IM4117S	SatinSheet 2Direction PillowCase
---------	----------------------------------

Información de mantenimiento

Inspección

Primera inspección:

- Está el envoltorio intacto?
- Lea la etiqueta del envoltorio y compruebe el número del artículo y la descripción del producto.
- Compruebe que estén incluidas las Instrucciones resumidas (puede descargar el Manual/las Instrucciones de uso del sitio web www.etac.com o poniéndose en contacto con el Servicio de atención al cliente de Etac o con su distribuidor local)
- Compruebe la etiqueta del producto. ¿Incluye el número del artículo, la descripción del producto, el número del lote, las instrucciones de limpieza y el nombre del proveedor?

Inspección periódica:

- Asegúrese de que su sistema de movilización manual esté siempre en perfecto estado.
- Después de lavarlo, compruebe siempre los materiales, las costuras, las asas y las hebillas.
- Si el producto presenta signos de desgaste y rotura, deberá retirarlo inmediatamente de servicio.



Inspección visual/Comprobación del producto:

Asegúrese de que los materiales, las costuras, las puntadas, las asas y las hebillas estén intactos/perfectos.



Test de estabilidad:

Intente doblar el producto y compruebe que parezca firme, estable y sólido.

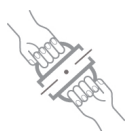

Carga o esfuerzo mecánicos/Comprobación de las asas:

Tire con fuerza de las asas en direcciones opuestas y verifique el material, las costuras y las puntadas.



Comprobación de la fricción baja/alta:

Coloque el producto sobre una superficie firme o una cama, ponga las manos sobre el material y compruebe la fricción deslizando las manos sobre el producto en sentido ascendente y descendente.

Fricción baja: se deslizan sin esfuerzo.

Fricción alta: no se deslizan/mueven.

Comprobación de las hebillas:

Fije las hebillas y tire de ellas en direcciones opuestas, verifique la hebilla y las puntadas.

Compruebe:

Dispositivos de ayuda de traslado manual con asas, correas y hebillas:

Dispositivos de ayuda de traslado manual para el traslado sentado y tumbado con una fricción alta o baja:



Año, mes y día de producción



El producto se puede desechar de conformidad con la normativa nacional.



Leer el manual de usuario



Etac Immedia A/S
Parallelvej 3
DK-8751 Gedved
www.etac.com

UK Responsible Person.
"Etac Ltd. Unit D4A, Coombswood Business Park East,
Coombswood Way Halesowen, West Midlands B62 8BH"

E-mail: enquiries@etac.uk.r82.com
Website: www.etac.com/uk
Phone: +44 0121 561 222



 **etac**[®]
Creating Possibilities