

User Instructions

Biometric Standing System "Da Vinci"



Table of contents

1. Preface	4
2. Legal Terms.....	5
2.1. Intended use	
2.2. Risks	
2.3. Responsibility	
2.4. Declaration of conformity	
3. Safety Precautions.....	7
3.1. Signs and Symbols	
3.2. Safety Precautions	
4. Overview: product and delivery.....	8
4.1. Delivery contents	
4.2. Check parts	
4.3. Accessories	
5. Preparing the device	10
5.1. Transport casters	
5.2. Lateral trunk supports (optional)	
5.3. Pelvic supports	
5.4. Knee blocks	
5.5. Tilting the entire biometric standing system	
6. Adjusting the device for the patient	12
6.1. Head support	
6.2. Lateral trunk supports (optional)	
6.3. Pelvic supports	
6.4. Anatomic knee blocks	
6.5. Biometric backrest (several segments)	
6.6. Biometric pelvic support	
6.7. Individual biometric leg supports	
6.8. Individual footplates	
6.9. Tilting the entire biometric standing system	
7. Technical Data	20
8. Care and Maintenance.....	21
8.1. Cleaning	
8.2. Service	
9. Passing on and Recycling	22
10. Type Signs	23
11. Warranty and Service	24
11.1. Terms of warranty	
11.2. Service/ complaints	

1. Preface

Dear User,

you chose a biometric standing system from Rehatec Dieter Frank GmbH. We would like to thank you for your trust in our products.

The innovative standing system "Da Vinci" offers highest comfort combined with greatest possible individuality. Multiple adjustment options provide maximum flexibility since each segment allows smooth adjustment of height, depth and tilt angle.

Please read the user manual carefully before starting to operate your new standing system. Please keep this manual close at hand.

These operating instructions were provided with the biggest care. Nevertheless, mistakes cannot be excluded. **Rehatec Dieter Frank GmbH** and authors take over for faulty information and their results neither juridical nor any responsibility.

2. Legal Terms

Intended use

The biometric standing system "Da Vinci" has been designed for physiological stabilization of the user. Maximum user weight is 70kg.

All safety precautions, advices and information in this manual have to be considered by the user, to insure safe and successful use of the device.

This product is made strictly for professional use by trained and operator-instructed persons. Areas of use are: physiotherapy, rehab, physical therapy and medical therapy.

Rehatec Dieter Frank GmbH gives no guarantee concerning suitability of this product for a particular therapeutic and diagnostic purpose.

The user/operator determines the purposeful use.

This medical product is intended for indoor use at room temperatures from 15°C to 35°C.

Use in wet rooms is not permitted. If disregarded it can cause severe damage and be dangerous for the user as well as the operator.

Risks

Depending on the medical condition and the therapeutic goal, it is important to clarify with the physician or therapist, for how long the patient is able to stay in the standing system. The following symptoms might occur:

- Problems with circulation
 - Pain in leg and/or back area
- Increase of spasticity
- Seizures

Many users have to initially stand in a flexed position and only later can be fully extended. Never correct the position with force or hard pressure.

Responsibility

Alterations, repairs, maintenance work and upgrades of the system may only be carried out by authorized persons.

Rehatec Dieter Frank GmbH warranty applies only when the product is used according to the specified conditions and for the intended purposes.

Declaration of Conformity

Rehatec Dieter Frank GmbH as manufacturer with sole responsibility declares that the biometric standing system "Da Vinci" conforms to the requirements of the **93/42/EWG Guidelines Medical Device Regulations**.



3. Safety

Signs and Symbols



Attention! Used especially for information concerning safety.



Important! Used especially for useful information in the respective context.

Safety Precautions



Before using the standing system, checks that all attached parts are secured. Please examine the tightness of the screwed connections of all adjustable parts. This is particularly important for all adjustments with two clamp connections.



Combinations of the standing system with other products of any kind could bear danger.

Rehatec does not extend warranty for damages and complications resulting from such combinations.

- Helpers must be instructed in safe handling of the device.
- Any person operating the device has to be authorized or instructed.
Prevent unauthorized persons from interfering with the device.
- Depending on condition and weight, there might be need for 1-2 helpers to lift the patient onto the device.
- With defects the device may not be used.
- Repair and adjustment require special technical training and may only be carried out by specialist suppliers, authorized by Rehatec.
- The product contains plastic components (e.g. upholstery) and therefore should be kept away from all sources of temperatures above 80° (e.g. heaters, red lamps a.o.).

4. Overview: Product and Delivery

Delivery contents

Typically, the biometric standing system “Da Vinci” is delivered fully assembled and pre-adjusted to the user by the authorized supplier.

Standard delivery contents contain the following components:

- Head support (Mussel)
- Biometric backrest
- Butterfly harness
- Electric tilt mechanism
- Pelvic support
- Knee blocks (anatomic)
- Individual biometric leg supports
- Individual footplates
- Base frame with caster wheels 75mm / 125mm
- 1 allen key with red handle (to adjust the head support)
- 1 allen key with blue handle (to adjust the knee blocks)

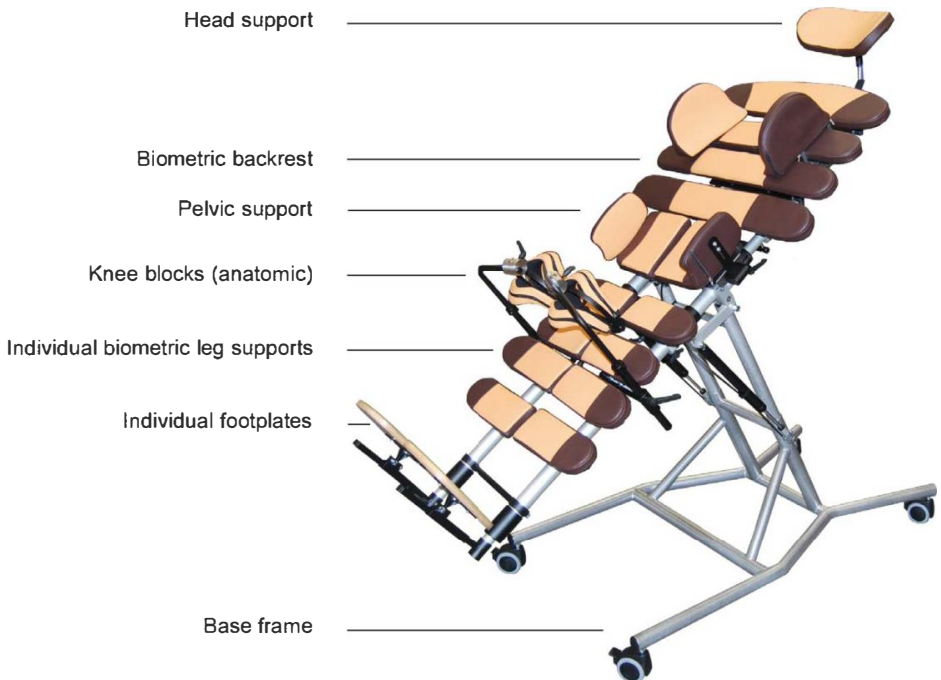

Check parts

Please check thoroughly if the delivery is complete and intact. In case of damage or incompleteness, please contact our customer service: phone (49) 6228-9136-0.

Always indicate the serial number when ordering further accessories or replacement parts. The serial number is printed on the type sign (see "10.Type signs" on page 23).

Accessories

The following parts/accessories are available:

- Tray with depth- and angle adjustment
- Rim for tray
- Lateral trunk supports
- ASIS (anterior superior iliac spine) support
- Pelvic belt
- Pes equinus correction
- Foot holders incl. foot straps

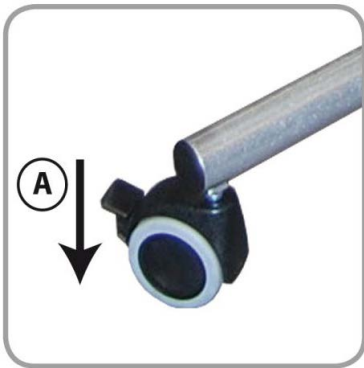

Picture 1: Caster wheels

5. Preparing the device



Please follow the below listed steps before transferring the user onto the biometric standing system "Da Vinci".

Caster wheels

Locking the caster wheels (image 1)

1. Place the biometric standing system on even, nonslip surface.
2. Lock all 4 casters.

Lateral trunk supports (optional)

Optionally available accessory; please note assembly instructions where applicable.

Releasing the lateral trunk supports (image 2)

1. Loosen the wing nut at the back of the trunk support (A) by one turn.
2. Slide the trunk support all the way outwards (B).
3. Swing the trunk support all the way out (C).
4. Repeat step 1 - 3 for the second trunk support.

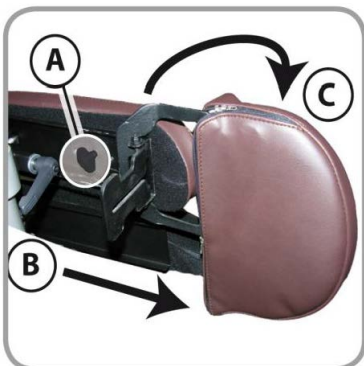

Picture 2: Lateral trunk supports



Pelvic supports

Release (image 3)

1. Loosen locking pin (A) of the pelvic support.
2. Swing pelvic support outwards (B).
3. Repeat step 1-2 for the second pelvic support.

Picture 3: Pelvic supports

Knee blocks

Swinging outwards (image 4)

1. Open locking lever (A) at the mounting of the knee block.
2. Rotate the knee block inside the guide-tube outwards (B), until the user can be laid on the standing system unimpeded.
3. Repeat step 1-2 to move aside the second knee block.



Picture 4: Knee blocks

Hand switch operation



Keep the handset away from magnetic objects and strong magnetic fields.



Before you can adjust the standing aid, it must be connected to the power supply. (See chapter "Commissioning the drive")

With the help of the hand switch, the Lasse can be sleeplessly adjusted.

- ① Select "UP" or "DOWN".
Hold down the button and place the patient in the desired position.
Release the button at the desired position.
- ② On the back of the handset there is a fold-out hook.
- ③ The hook can be used to hook the hand switch as desired.

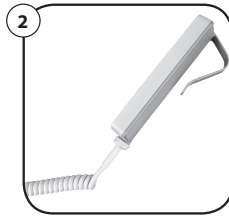
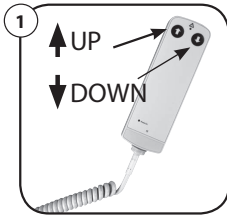

Functions of the display

Function LED **(A)**

LED lit green at push-button pressure (visual display of first-fault safety)

Power On-LED **(B)**

- when main / battery voltage is applied
 - LED is permanently on
- in battery operation (without main voltage)
 - LED only illuminates when pushing the button
- with battery charging
 - LED flashes when the battery is charging
 - LED is permanently on when the battery is full or not connected during main operations

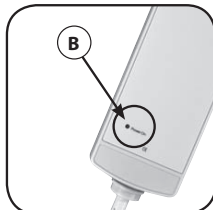
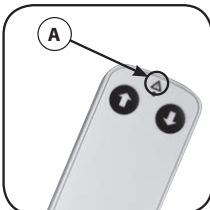

Startup of the drive without battery



Make sure that no persons can injure themselves during the use of the drive!

Keep the drive and all moving parts in view!

The electric adjustment drive is not intended for use by small children or frail persons without supervision.

The connection cable is not overdrive-resistant, a mechanical load is to be avoided.

Emergency stopping is performed by pulling the mains plug. Therefore, the power plug must always be accessible during operation, in order to be able to pull it out of the socket quickly in an emergency!



Delayed commissioning

The device is ready for operation when it is connected to the power supply (220 V). After the voltage supply has been established, the device switches on delayed. Wait at least 15 seconds before commissioning.

Duty cycle

The drive must not exceed max. 2 min. Under rated load, then 18 min. Pause. Or. The drive max. 5 Drive cycles per minute under rated load, otherwise a functional failure may occur.

Break / motor stop time

A rapid, alternating changeover from an executed direction of travel in the opposite direction, without observing an engine stop, must be avoided. A pause time (engine stop time) must be carried out via the manual switch.

Triggering the temperature monitoring

The temperature monitoring of the control unit triggers when the temperature is too high. If this has tripped, leave the control unit in the neutral position for approx. 20 - 30 minutes with the mains plug disconnected, then plug the plug back into the socket. The device should then be ready for operation again.

Connect the device to the power supply by plugging the mains plug into a mains socket (220 V).

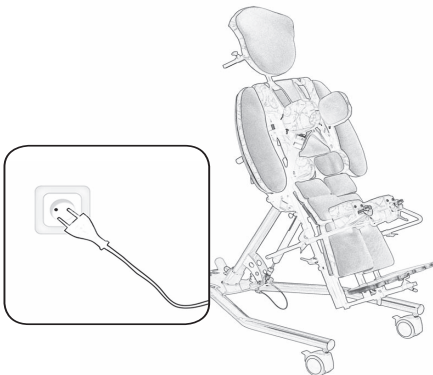

Battery powered accessories



The assembly and disassembly of the parts and cables may only be carried out in a voltage-free state.

Mounting / connecting battery

- 1 Screw the support plate **A** to the support plate **B**.

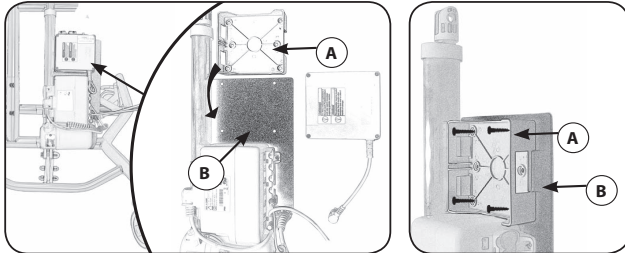

- 2 Insert the battery **C** into the holder **A** by snapping it into place.

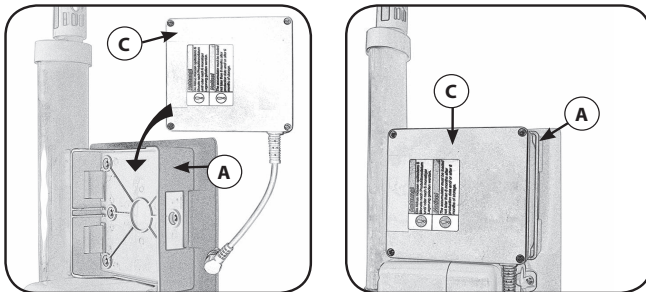

Open the pull-out protection

- 1 Use a suitable tool to press the three dents **A** into the recesses. Push the pull-out safety device forward so that the latching lugs are released from the recesses.
- 2 Pull out the extractor.
- 3 The plug can now be plugged into the appropriate socket or removed.
- 4 Plug the connector of the battery connection cable into the battery socket of the control unit and close the pull-out fuse **2** again.





Bild 6: Height adjustment of head support



Bild 7: Depth adjustment of head support

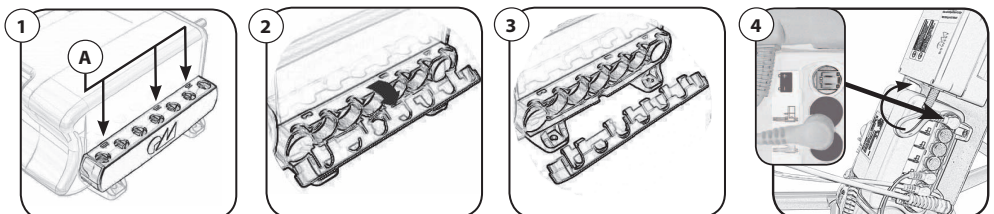

Bild 8: Angle adjustment of head support

6. Adjusting the device to the user

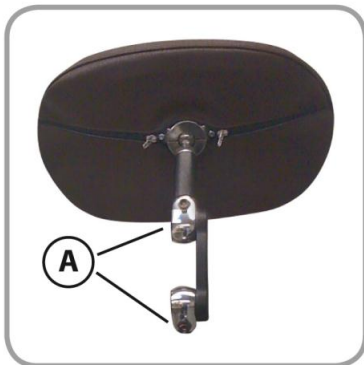

Before using the biometric standing system "Da Vinci" you have to adjust it to the body measurements of the user!

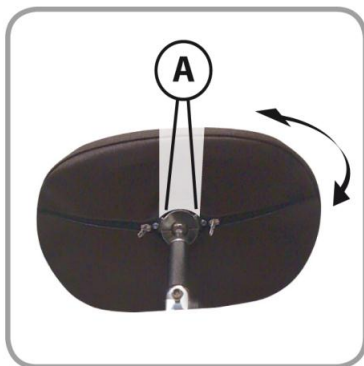
Every single edition of the back edition can be shifted by height, depth and inclination infinitely variable. The pelvic edition is also adjustable in three dimensions. About joints adjustable leg edition segments allow an optimum adaptation to the contour of the legs.

Head support

Height adjustment (image 6)

1. Loosen locking lever (A).
2. Move head support to desired height.
3. Retighten locking lever (A).

Depth adjustment (image 7)

1. Loosen allen bolts at the joints of the head support (A) with allen key (blue handle).
2. Move head support to desired position.
3. Retighten allen bolts.

Angle adjustment (image 8)

1. Loosen allen bolts at ball joint of the head support (A) with allen key (red handle).
2. Move head support to desired position.
3. Retighten allen bolts at ball joint (A).

Lateral trunk supports (optional)

The optionally available lateral trunk supports guide the thoracic position. The following steps describe adjustment of one trunk support and have to be carried out in the same order for the second one.

Fitting to the user's ribcage (image 9)

1. Loosen wingnut (A) at the trunk support mounting at the back of the backrest by one turn.
2. Swing trunk support toward the ribcage until it sits at 90° on the backrest (B).
3. Slide the entire trunk support towards the user's ribcage (C).
4. Retighten wingnut (A).
5. Repeat step 1-4 for the other trunk support.



Bild 9: Lateral trunk supports

Pelvic supports

The pelvic supports guide the position of the pelvic area. The following steps describe adjustment of one pelvic support and have to be carried out in the same order for the second one.

Fitting to the user's pelvis (image 10)

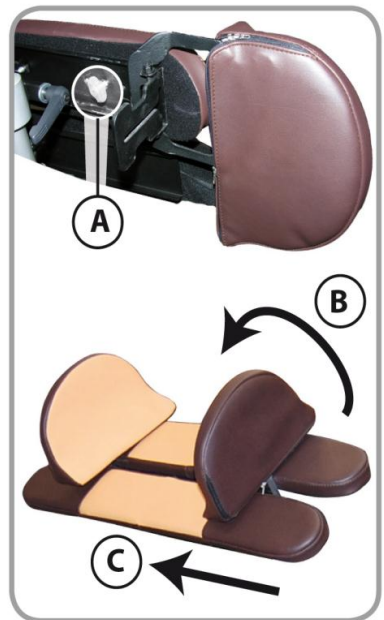
1. Pull locking pin (A).
2. Swing pelvic support inwards and slide it toward the user's pelvis.
3. Release locking pin (A).
4. Repeat step 1-3 for the other pelvic support.



Bild 10: Pelvic support



Bild 11: Knee block mounting

Anatomic knee blocks

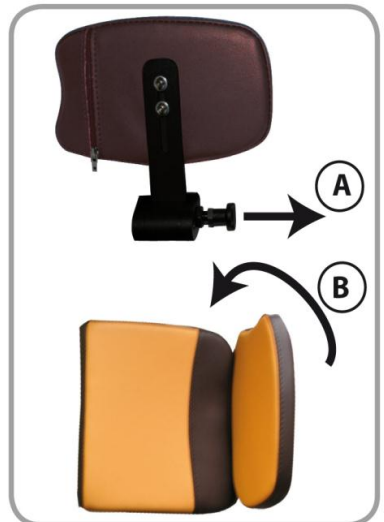
The anatomically knee blocks control the position of the knees. The following steps describe adjustment of one knee block and have to be carried out in the same order for the second one.

Please pay attention to the mounting instruction!

Knee block mounting (image 11)

1. Loosen locking lever (A) at the knee block mounting.
2. Rotate the knee block mounting inside the guide-tube over the user's knee (B).
3. Retighten locking lever (A).
4. Repeat step 1-3 to position the other knee block.

Triple knee block adjustment (image 12)

1. Loosen locking lever (A) at the knee block triple-adjustment.
2. Adjust knee block triple-adjustment to the position of the user's knee.
3. Movable knee block adapt to the knee of the patient.
4. Retighten locking lever (A) at the knee block triple-adjustment.
5. Repeat step 1-4 for adjustment of the second knee block.



Bild 12: Triple knee block adjustment

Biometric Backrest (multiple support segments)

The biometric backrest is made up of several individual support segments, which can be fitted flexibly to the shape of the user's back. The following steps describe adjustment of one separate back support segment and have to be carried out in the same order for any further segment.

Height adjustment (image 13)

1. Loosen both wing nuts (A) at the mounting.
2. Adjust individual support segment to the user.
3. Retighten wing nuts (A).

Depth adjustment (image 14)



The depth of each individual support segment can be fitted very flexibly to the back of the user.

1. Loosen locking lever (A) with left hand.
2. Move the horizontal handle (B) at the back of the segment in depth and angle to adjust it to the corresponding part of the user's back.
3. Firmly hold the handle in position with the right hand and retighten the locking lever (A) with the left hand at the same time.

Adjusting the entire backrest (image 15)

1. Loosen both locking levers (A).
2. Move entire biometric backrest to desired position.
3. Retighten both locking levers (A).



Bild 13: Height adjustment of backrest



Bild 14: Depth adjustment of backrest

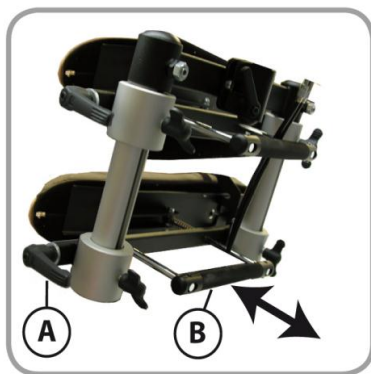

Bild 15: Adjusting the entire backrest

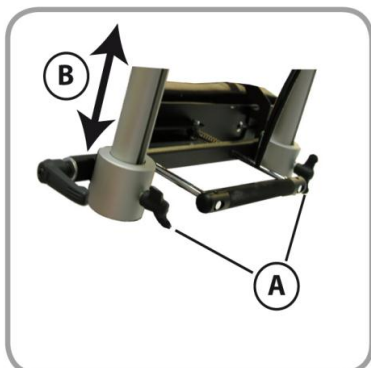

Bild 16: Height adjustment of individual support

Biometric pelvic support

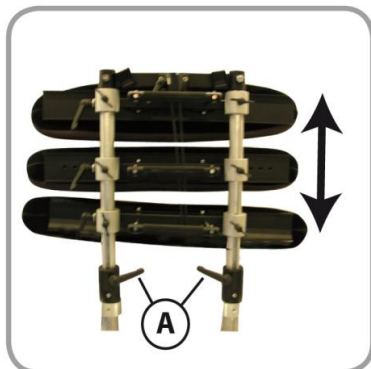
The biometric pelvic support consists of two individual supports which should be fitted flexibly to the pelvis.

The following steps describe adjustment of one individual pelvic support and have to be carried out in the same order for the second one.

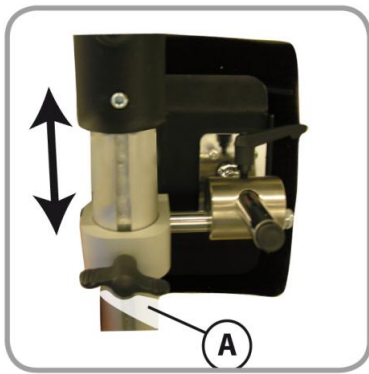
Height adjustment (image 16)

1. Loosen wingnut (A).
2. Push the individual support along the guide tube to fit the pelvis.
3. Retighten wingnut (A).



Bild 17: Angle- and depth adjustment of individual support

Angle- and depth adjustment (image 17)

1. Loosen locking lever (A).
2. Adjust angle and depth to fit the position of the pelvis.
3. Retighten locking lever (A).

Individual biometric leg support

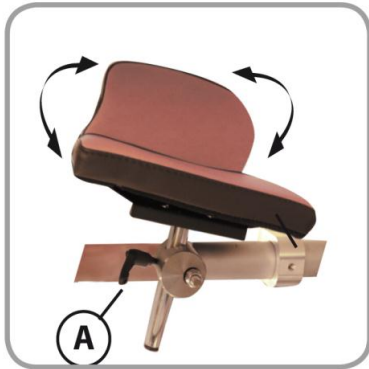
The biometric leg supports is made up of multiple separate supports which should be exactly fitted to the position of the legs.

The following steps describe adjustment of one separate leg support and have to be carried out in the same order for any leg support.

Height adjustment (image 18)

1. Loosen wing nut (A).
2. Adjust height of the leg support to the position of the user's leg.
3. Retighten wing nut (A).



Bild 18: Height adjustment of leg support

Angle- and depth adjustment (image 19)

1. Loosen locking lever (A).
2. Adjust angle and depth of the leg support to the position of the user's leg.
3. Retighten locking lever (A).

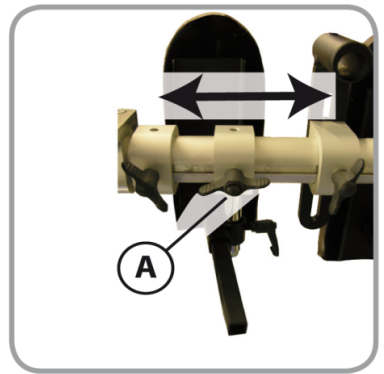

Bild 19: Angle- and depth adjustment of leg support



Bild 20: Height adjustment of individual footplates

Individual footplates

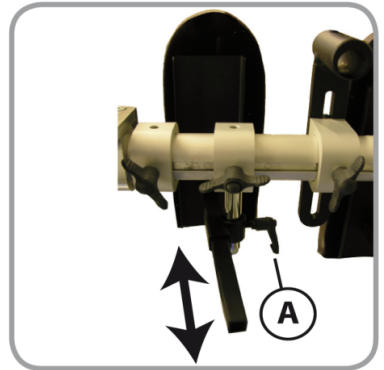
Two footplates belong with the biometric standing system "Da Vinci". They should be adjusted to the needed height of the user's feet. The various adjustment options allow for adjustment of foot length and ankle position as well as for consideration of therapeutic goals (e.g. correction of pes equinus where accessories available).

The following steps describe adjustment of one footplate and have to be carried out in the same order for the second footplate.

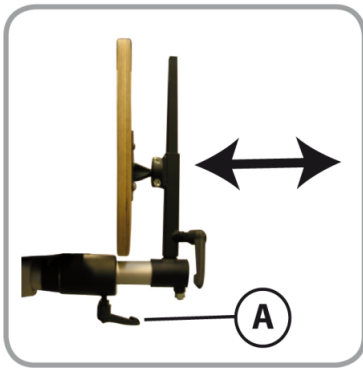
Height adjustment (image 20)

1. Loosen locking lever (A).
2. Adjust the footplate to the foot of the user.
3. Retighten locking lever (A).



Bild 21: Length adjustment of the footplate

Length adjustment of the footplate (image 21)

1. Loosen large locking lever (A).
2. Adjust length of the footplate.
3. Retighten locking lever (A).

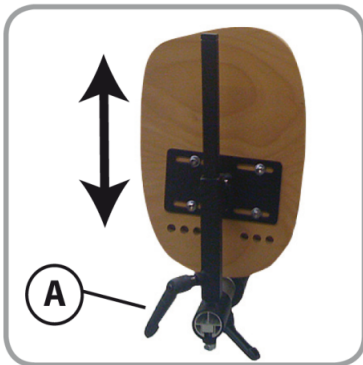

Bild 22: Angle adjustment of the footplate

Angle adjustment (image 22)

1. Loosen allen bolt at the ball joint (A) underneath the footplates with blue allen key.
2. Adjust to desired position of the user's foot.
3. Retighten allen bolts.

Tilting of the entire biometric standing system “Da Vinci”

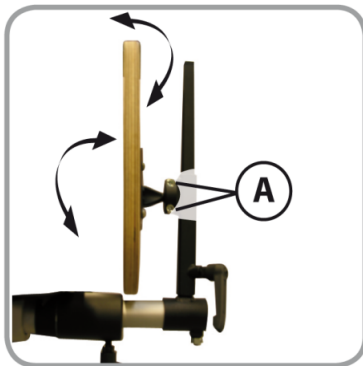

To prevent problems with blood circulation, erect the user slowly and step by step!

The tilt mechanism of the biometric standing system “Da Vinci” gives the user the chance to slowly get used to the upright position and allows a slow adjustment of the cardio-vascular system to the vertical position.

Moving the standing system to an upright position (image 23)

1. With one hand, hold the mounting of the head support and the releasing lever (A) at the rear side of the top of the backrest. Squeeze the releasing lever in the direction of the arrow.
2. Keep the releasing lever (A) squeezed while moving the entire biometric standing system into a vertical position.
3. Let go of the releasing lever.



Use the same releasing lever to move the user back into the horizontal position.

See: **“Tilting the entire standing system”** on page 11



Bild 23: Tilting angle adjustment

7. Technical Data

Størrelse	1	2
Artikkelnr.	168D1	169D2
Brukerhøyde	120 - 155 cm	150 - 180 cm
Hoftebredde	25 - 40 cm	25 - 40 cm
Brystbredde	25 - 41 cm	25 - 41 cm
Brukervekt	70 kg	90 kg



Make sure that no persons can injure themselves during the use of the drive!

Keep the drive and all moving parts in view!

The electric adjustment drive is not intended for use by small children or frail persons without supervision.

The connection cable is not overdrive-resistant, a mechanical load is to be avoided.

Emergency stopping is performed by pulling the mains plug. Therefore, the power plug must always be accessible during operation, in order to be able to pull it out of the socket quickly in an emergency! Pull the battery pack from the control socket.



Begun commissioning

The device is ready for operation when it is connected to the power supply (220 V). After the voltage supply has been established, the device switches on delayed. Wait at least 15 seconds before commissioning.

Duty cycle

The drive must not exceed max. 2 min. Under rated load, then 18 min. Pause. Or. The drive max. 5 Drive cycles per minute under rated load, otherwise a functional failure may occur.

Break / motor stop time

A rapid, alternating changeover from an executed direction of travel in the opposite direction, without observing an engine stop, must be avoided. A pause time (engine stop time) must be carried out via the manual switch.

Triggering the temperature monitoring

The temperature monitoring of the control unit triggers when the temperature is too high. If this has tripped, leave the control unit in the neutral position for approx. 20 - 30 minutes with the mains plug disconnected, then plug the plug back into the socket. The device should then be ready for operation again.

Battery backup power supply

The battery is only used as an emergency power supply. The mains connection should always be produced as much as possible.

Connect the device to the power supply by plugging the mains plug into a mains socket (220 V).

8. Care and Maintenance

Cleaning



Never use household cleaners, disinfectants or similar cleaners.

Never disinfect the device!

- The base frame and chrome parts should be cleaned with a soft, slightly damp cloth.
- The wooden parts can also be cleaned with a damp cloth.
- The upholstery can be cleaned with a mild soap and water solution.

Maintenance



Do not use a defect device.

By disturbances or defects you inform your specialist supplier or an authorised person.

- Check for loose screws on a regular bases.
- Check the function of the locking brakes regularly.

9. Passing on and Recycling

When passing on the device, please hand over all device related documents to the new owner.

For recycling please consult with your supplier.

10. Type Signs

For clear identification there is a type sign attached to one of the crossbars of the base frame (see **“delivery contents” on page 10**).

The exact type label and the serial number of your device are printed on the type sign.



11. Warranty and Service

Warranty extends to defects of the product as result of provable flaws of material or workmanship. A three year warranty is provided for all frame parts of the biometric standing system "Da Vinci". Defect parts will be replaced free of cost. The manufacturer will not take responsibility in the case that constructive intervention and changes have taken place, which exceed the device's adjustability in regard to the user's size.

Exempted from the warranty are only upholstery, wooden parts and fabrics.

There is no further liability for consequential damages, especially when the device is not used for the intended purpose.

Terms of warranty

- Complaints have to be made in writing
- The warranty shall not extend to products that have been altered without written permission from Rehatec
- Damaged or replaced parts are property of Rehatec

Service/Claims

For claims, questions and further information or orders of accessories and upgraded additional equipment, please contact **Rehatec Dieter Frank GmbH**:

REHATEC[®] Dieter Frank GmbH

In den Kreuzwiesen 35

69250 Schönau

Phone: +49 (6228) 9136-0

Fax: +49 (6228) 9136-99

Internet: www.rehatec.com

E-Mail: info@rehatec.com

REHATEC® Dieter Frank GmbH

In den Kreuzwiesen 35

69250 Schönau

Phone: +49 (6228) 9136-0

Fax: +49 (6228) 9136-99

Internet: www.rehatec.com

E-Mail: info@rehatec.com

WARRANTY CARD

Congratulations! You purchased a high-quality device from the company Rehatec.

The below identified Rehatec Product is of perfect quality and functional construction.

Any damage as a result of material defects will be remedied free of cost by Rehatec within a three year time frame, starting with the date of purchase.

Exempted from the warranty are only upholstery, wooden parts and fabrics.

Name of device: **Biometric standing system "Da Vinci"**

Serial-number:

Date of purchase:

Supplier's stamp and signature



Notes:

Leverandør:



Rosenholmveien 22, 1252 Oslo
Tlf: 66 81 60 70 • Fax: 66 81 60 71
firmapost@hm-spes.no • www.hm-spes.no