



Drehhilfe

Gebrauchsanweisung

Turnable

Operating instructions

Transfert

Mode d'emploi

Draaihulp

Gebruiksaanwijzing

Mezzo ausiliario di rotazione

Istruzioni per l'uso

Ayuda para girarse

Manual de instrucciones

Suporte/ajuda giratória

Manual de instruções

Vridplatta

Bruksanvisning

Kääntölevy

Käyttöohje

Dreiehjelp

Bruksanvisning

Drejeplade

Betjeningsvejledning



AQT00284

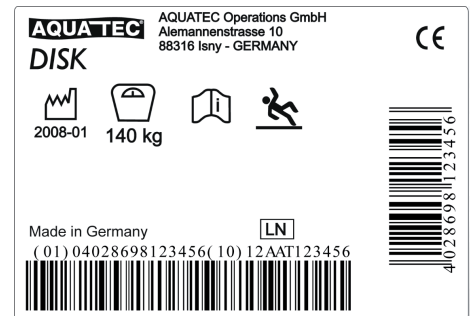

AQT00623

Sicherheitshinweise
Safety instructions
Consignes de sécurité
Veiligheidsinstructies
Indicazioni di sicurezza
Indicaciones de seguridad
Instruções de segurança
Säkerhetsanvisningar
Turvaohjeet
Sikkerhetskennvisninger
Sikkerhedshenvisninger



Bei Defekt nicht verwenden
Do not use if defective
Ne pas utiliser en cas de défaut
Indien defect niet gebruiken
Non impiegarlo se difettoso
No utilizar en malas condiciones
Não utilizar se estiver danificado
Använd inte produkten om den är trasig
Älä käyttää viallista tuotetta
Må ikke brukes når den er defekt
Må ikke anvendes, hvis den er defekt

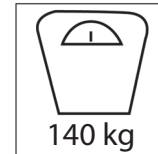

Max. Belastung
Max. load
Charge max.
Max. belasting
Portata max.
Carga máx.
Peso máximo
Max. belastning
Maks. kuormitus
Maks. belastning
Maks. belastning



Rutschgefahr
Danger of slipping
Risque de glissement
Glijgevaar
Pericolo di scivolare
Peligro de resbalamiento
Perigo de escorregar
Halkrisk
Liukastumisvaara
Skilfare
Fare for at glide

Lieferumfang
Scope of delivery
Volume de livraison
Omvang van de levering
Fornitura
Volumen de entrega
Volume de entrega
Leveransomfattning
Toimituskokonaisuus
Leveringsomfang
Indeholdt i leveringen

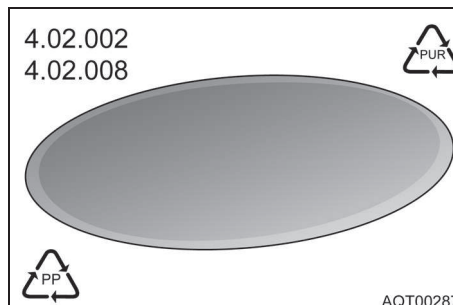

AQT00287

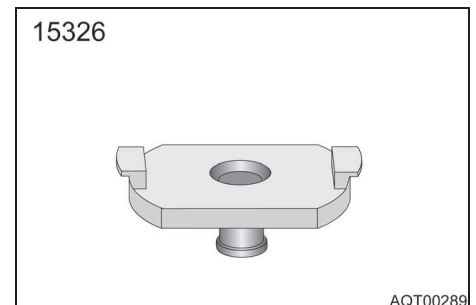

AQT00289

Benutzen
Use
Utilisation
Gebruiken
Utilizzo
Utilización
Utilização
Användning
Käyttö
Bruk
Brug

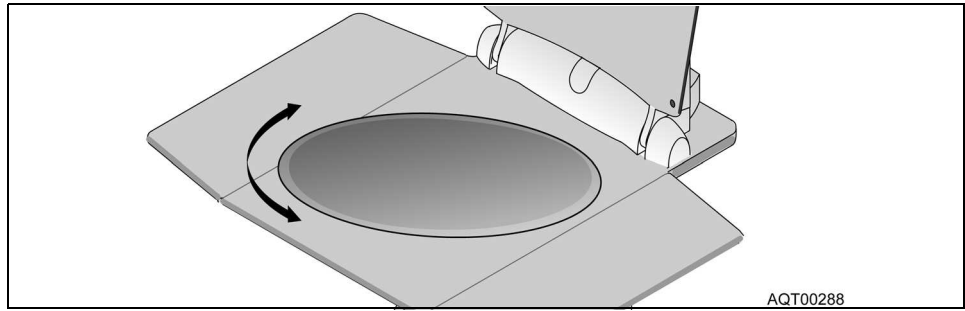

AQT00288

DISK ON DOT

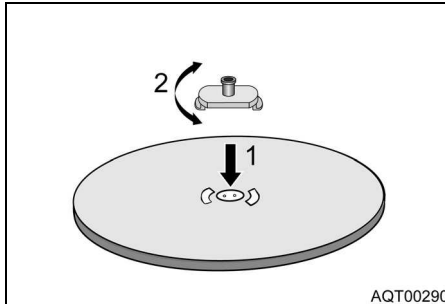

AQT00290

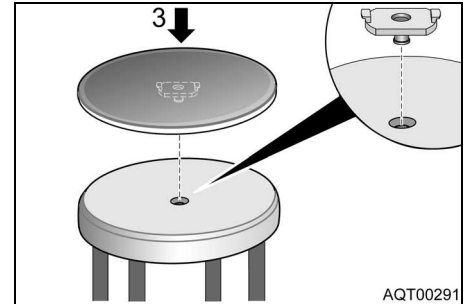

AQT00291

Reinigen
Cleaning
Nettoyage
Reinigen
Pulizia
Limpieza
Limpeza
Rengöra
Puhdistaminen
Rengjøring
Rengöring

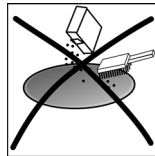

Ohne Scheuermittel reinigen
Clean without scouring agent
Ne pas utiliser de produits récurrents pour le nettoyage
Zonder schuurmiddelen reinigen
Non pulirlo con prodotti abrasivi
No utilizar productos abrasivos para su limpieza
Não utilize produtos de limpeza abrasivos
Använd inte skurmedel
Puhdista ilman hankausaineita
Bruk ikke skuremiddel ved rengjøring
Rengør uden skuremiddel

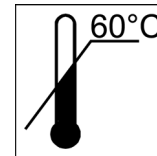

Reinigungstemperatur max. 60 °C
Max. cleaning temperature: 60 °C
Température de nettoyage 60 °C max.
Reinigungstemperatur max. 60 °C
Temperatura max. durante la pulizia 60 °C
Temperatura máx. de limpeza 60 °C
Temperatura máxima de limpeza 60 °C
Rengjøringstemperatur max. 60 °C
Puhdistuslämpötila maks. 60 °C
Temperatur ved rengjøring maks. 60 °C
Rengöringstemperatur maks. 60 °C

D

INVACARE GmbH
Alemannenstraße 10
D-88316 Isny
Telefon 07562 700-0
Telefax 07562 700-66
E-Mail kontakt@invacare.com
Internet www.invacare.de

CH

INVACARE® AG
Benkenstrasse 260
CH-4108 Witterswil
Telefon 061 487 70 80
Telefax 061 487 70 81
E-Mail switzerland@invacare.com
Internet www.invacare.ch

A

INVACARE® AUSTRIA GmbH
Herzog Odilostraße 101
A-5310 Mondsee
Telefon 06232 5535-00
Telefax 06232 5535-4
E-Mail info@invacare-austria.com
Internet www.invacare-austria.at

FIN

Algol-Trehab Oy
Karapellontie 6
02610 Espoo
Puhelin 09 50991
Faksi 09 5099490
Sähköposti info.algotrehab.fi@algot.fi
Internet www.algotrehab.fi

F

INVACARE® Poirier S.A.S.
Route de St Roch
F-37230 Fondettes
Téléphone 0247 626466
Téléfax 0247 421224
E-mail contactfr@invacare.com
Internet www.invacare.fr

DK

INVACARE® A/S
Sdr. Ringvej 37
DK-2605 Brøndby
Telefon 036 90 00 00
Telefax 036 90 00 01
E-mail denmark@invacare.com

S

INVACARE® AB
Fagerstagan 9
S-163 91 Spånga
Telefon 08 761 70 90
Telefax 08 761 81 08
E-Post sweden@invacare.com
Hemsida www.invacare.se

CDN

INVACARE® CANADA INC.
570 Matheson Blvd. E., Unit 8
CDN Mississauga
On. L4Z 4G4
Telephone 0905 8908300
Telefax 0905 8905244
Internet www.invacare.ca

E

INVACARE® S.A.
c/Areny
s/n - Poligon Industrial de Celrà
E-17460 Celrà (Girona)
Teléfono 972 493200
Telefax 972 493220
E-mail contactsp@invacare.com
Internet www.invacare.es

N

INVACARE® AS
Grensesvingen 9
Postboks 6230, Etterstad
N-0603 Oslo
Telefon 22 57 95 00
Telefax 22 57 95 01
E-mail norway@invacare.com
Hjemmeside www.invacare.no

B

INVACARE® nv
Autobaan 14
B-8210 Loppem, Brugge
Telefoon 0 50 83 10 10
Fax 0 50 83 10 11
E-Mail belgium@invacare.com
Internet www.invacare.be

GB

INVACARE® Limited
Pencoed Technology Part
UK-Bridgend CF35 5HZ
Telephone 01656 776200
Telefax 01656 776201
E-mail uk@invacare.com
Internet www.invacare.co.uk

P

INVACARE® Lda
Rua Estrada Velha, 949
P-4465-784 Leça do Balio
Telefone 225 1059 46/47
Telefax 225 1057 39
E-mail portugal@invacare.com
Internet www.invacare.pt

I

INVACARE® Mecc San s.r.l.
Via dei Pini, 62
I-36016 Thiene (VI)
Telefono 0445 380059
Telefax 0445 380034
E-mail italia@invacare.com
Internet www.invacare.it

NL

INVACARE® BV
Celsiusstraat 46
NL-6716 BZ Ede
Telefoon 0318 695 757
Fax 0318 695 758
E-Mail nederland@invacare.com
csede@invacare.com

USA

CLARKE HEALTH CARE PRODUCTS Inc.
1003 International Dr.
USA-Oakdale, PA 15071-9226
Telephone 0724 69 52 122
Telefax 0724 69 52 922
E-mail info@clarkehealthcare.com
Internet www.clarkehealthcare.com

AQT-0007-10XL

© 2012 Aquatec Operations GmbH D-88316 Isny
Art.-Nr.: 15633 - Stand: 12/2012