



Drehhilfe

Gebrauchsanweisung

Turnable

Operating instructions

Transfert

Mode d'emploi

Draaihulp

Gebruiksaanwijzing

Mezzo ausiliario di rotazione

Istruzioni per l'uso

Ayuda para girarse

Manual de instrucciones

Suporte/ajuda giratória

Manual de instruções

Vridplatta

Bruksanvisning

Kääntölevy

Käyttöohje

Dreihjelp

Bruksanvisning

Drejeplade

Betjeningsvejledning



AQT00284



AQT00285

Sicherheitshinweise
Safety instructions
Consignes de sécurité
Veiligheidsinstructies
Indicazioni di sicurezza
Indicaciones de seguridad
Instruções de segurança
Säkerhetsanvisningar
Turvaohjeet
Sikkerhetskennvisninger
Sikkerhedshenvisninger

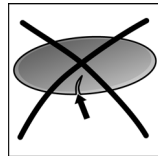

Bei Defekt nicht verwenden
Do not use if defective
Ne pas utiliser en cas de défaut
Indien defect niet gebruiken
Non impiegarlo se difettoso
No utilizar en malas condiciones
Não utilizar se estiver danificado
Använd inte produkten om den är trasig
Älä käyttää viallista tuotetta
Må ikke brukes når den er defekt
Må ikke anvendes, hvis den er defekt

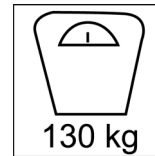

Max. Belastung
Max. load
Charge max.
Max. belastning
Portata max.
Carga máx.
Peso máximo
Max. belastning
Maks. kuormitus
Maks. belastning
Maks. belastning



Rutschgefahr
Danger of slipping
Risque de glissement
Glijgevaar
Pericolo di scivolare
Peligro de resbalamiento
Perigo de escorregar
Halkrisk
Liukastumisvaara
Skilfare
Fare for at glide

Lieferumfang
Scope of delivery
Volume de livraison
Omvang van de levering
Fornitura
Volumen de entrega
Volume de entrega
Leveransomfattning
Toimituskokonaisuus
Leveringsomfang
Indeholdt i leveringen

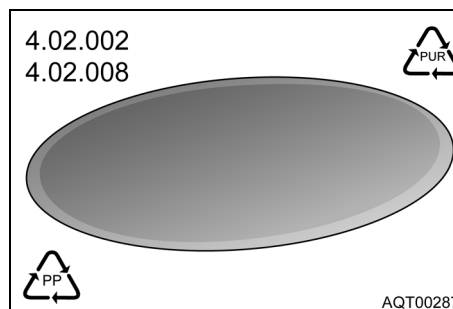

AQT00287

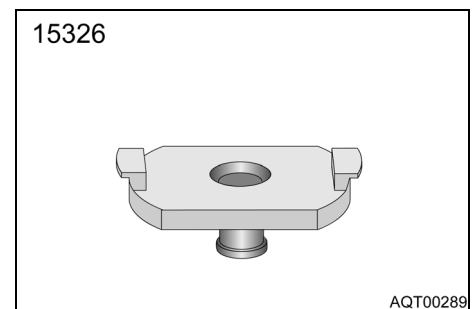

AQT00289

Benutzen
Use
Utilisation
Gebruiken
Utilizzo
Utilización
Utilização
Användning
Käyttö
Bruk
Brug

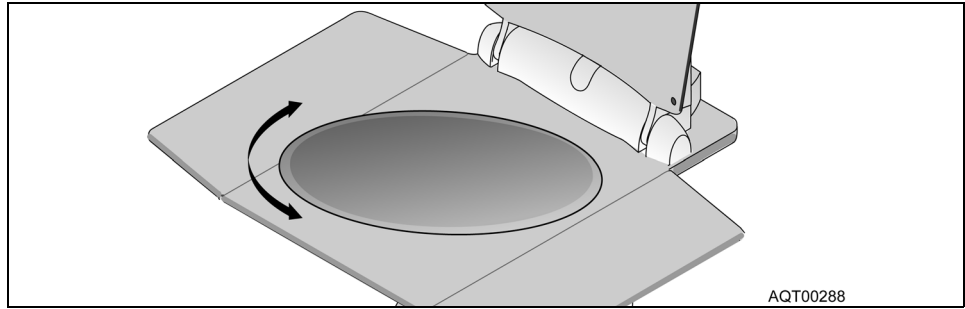

DISK ON DOT

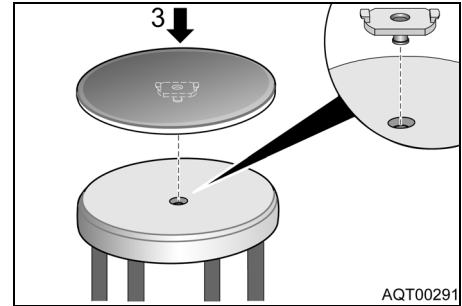
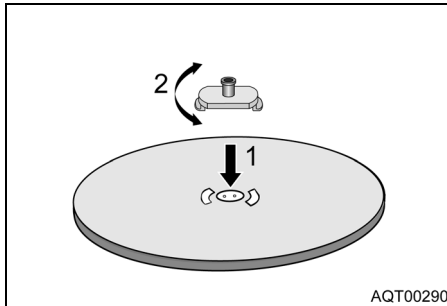

Reinigen
Cleaning
Nettoyage
Reinigen
Pulizia
Limpeza
Limpeza
Rengöra
Puhdistaminen
Rengjøring
Rengjøring

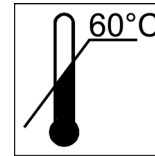
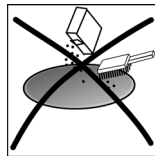

Ohne Scheuermittel reinigen
Clean without scouring agent
Ne pas utiliser de produits récurrents pour le nettoyage
Zonder schuurmiddelen reinigen
Non pulirlo con prodotti abrasivi
No utilizar productos abrasivos para su limpieza
Não utilize produtos de limpeza abrasivos
Använd inte skurmedel
Puhdista ilman hankausaineita
Bruk ikke skuremiddel ved rengjøring
Rengør uden skuremiddel

Reinigungstemperatur max. 60 °C
Max. cleaning temperature: 60 °C
Température de nettoyage 60 °C max.
Reinigungstemperatur max. 60 °C
Temperatura max. durante la pulizia 60 °C
Temperatura máx. de limpeza 60 °C
Temperatura máxima de limpeza 60 °C
Rengöringstemperatur max. 60 °C
Puhdistuslämpötila maks. 60 °C
Temperatur ved rengjøring maks. 60 °C
Rengjøringstemperatur maks. 60 °C

D
AQUATEC GmbH
Alemanenstraße 10
D-88316 Isny
Telefon 07562 700-0
Telefax 07562 700-66
E-Mail info@aquatec.de
Internet www.aquatec.de

CH
MOBITEC Rehab AG
Bahnhofstrasse 3
CH-5436 Würenlos
Telefon 05640 1520-0
Telefax 05640 1520-1
E-Mail office@mobitec-rehab.ch
Internet www.mobitec-rehab.ch

A
MOBITEC
Mobilitätshilfen GmbH
Herzog Odilostraße 101
A-5310 Mondsee
Telefon 06232 5535-00
Telefax 06232 5535-4
E-Mail mobitec@nextra.at

FIN
Algol Oy
Karapellontie 6
P.O. Box 13
02611 Espoo
Puhelin 09 50991
Fax 09 595 006
E-mail info@algol.fi
Internet www.algol.fi

F
Invacare® Poirier S.A.S.
Route de St Roch
F-37230 Fondettes
Téléphone 0247 626466
Téléfax 0247 421224
E-mail contactfr@invacare.com
Internet www.invacare.fr

DK
NEBA AS
Baldersbuen 17, Box 220
DK-2640 Hedehusene
Telefon 046 59 01 77
Telefax 046 59 01 97
E-mail neba@neba.dk
Internet www.neba.dk

S
DOLOMITE AB
Box 55, V. Götgatan 5
S-33421 Anderstorp
Telefon 0371 588400
Telefax 0371 17090
E-Post info@dolomite.se
Hemsida www.dolomite.se

CDN
Invacare® CANADA INC.
570 Matheson Blvd. E., Unit 8
CDN Mississauga
On. L4Z 4G4
Telephone 0905 8908300
Telefax 0905 8905244
Internet www.invacare.ca

N
Invacare® AS
Grensesvingen 9
N-0603 Oslo
Telefon 22 57 95 00
Telefax 22 57 95 01
E-mail norway@invacare.com
Hjemmeside www.invacare.no

E
Invacare® S.A.
c/Areny
s/n - Poligon Industrial de Celrà
E-17460 Celrà (Girona)
Telefono 972 493200
Telefax 972 493220
E-mail contactsp@invacare.com
Internet www.invacare.es

GB
BISON BEDE Ltd.
Unit 9
N°1 Industrial Estate
Medomsley Road
Consett, County Durham
DH8 6ST
Telephone 01207 5850-00
Telefax 01207 5850-85
E-mail sales@bisonbede.co.uk

GB
Invacare® Ltd
South Road
Bridgend Industrial Estate
Bridgend
CF31 3PY
Telephone 01656 753200
Telefax 01656 667532
E-mail uk@invacare.com
Internet www.invacare.co.uk

USA
CLARKE HEALTH CARE PRODUCTS Inc.
1003 International Dr.
USA-Oakdale, PA 15071-9226
Telephone 0724 69 52 122
Telefax 0724 69 52 922
E-mail info@clarkehealthcare.com
Internet www.clarkehealthcare.com

I
Invacare® Mecc San
Via dei Pini, 62
I-36016 Thiene (VI)
Telefono 0445 380059
Telefax 0445 380034
E-mail italia@invacare.com
Internet www.invacare.it

NL
RvS Nederland
Bolderweg 6
NL-1332 Almere
Telefoon 036 532 04 50
Fax 036 532 13 08
E-Mail info@rvsnederland.nl
Internet www.rvsnederland.nl

P
Invacare® PORTUGAL LDA
Rua Senhora de Campanhã, 105
P-4369-001 Porto
Telefon 225 105946
Telefax 225 105739
E-mail portugal@invacare.com

AQT-0007-03XL

© 2005 AQUATEC GmbH D-88316 Isny
Art.-Nr.: 15633 - Stand 04/05